

PTZ Camera with HDMI Output



AT-HDVS-CAM-HDMI

Atlona Manuals
Accessories

Version Information

Version	Release Date	Notes
4	Jan 2024	Updated warranty information

Sales, Marketing, and Customer Support

Main Office

Atlona Incorporated
70 Daggett Drive
San Jose, CA 95134
United States

Office: +1.408.962.0515

Sales and Customer Service Hours
Monday - Friday: 6:00 a.m. - 4:30 p.m. (PST)

<https://atlona.com/>

International Headquarters

Atlona International AG
Tödistrasse 18
8002 Zürich
Switzerland

Office: +41.43.508.4321

Sales and Customer Service Hours
Monday - Friday: 09:00 - 17:00 (UTC +1)

Operating Notes



IMPORTANT: Visit <http://www.atlona.com/product/AT-HDVS-CAM-HDMI> for the latest firmware updates and User Manual.

Warranty



To view the product warranty, use the following link or QR code:

<https://atlona.com/warranty/>.

Important Safety Information

CAUTION
 RISK OF ELECTRIC SHOCK
 DO NOT OPEN

CAUTION: TO REDUCE THE RISK OF ELECTRIC SHOCK DO NOT OPEN ENCLOSURE OR EXPOSE TO RAIN OR MOISTURE. NO USER-SERVICEABLE PARTS INSIDE REFER SERVICING TO QUALIFIED SERVICE PERSONNEL.



The exclamation point within an equilateral triangle is intended to alert the user to the presence of important operating and maintenance instructions in the literature accompanying the product.



The information bubble is intended to alert the user to helpful or optional operational instructions in the literature accompanying the product.

1. Read these instructions.
2. Keep these instructions.
3. Heed all warnings.
4. Follow all instructions.
5. Do not use this product near water.
6. Clean only with a dry cloth.
7. Do not block any ventilation openings. Install in accordance with the manufacturer's instructions.
8. Do not install or place this product near any heat sources such as radiators, heat registers, stoves, or other apparatus (including amplifiers) that produce heat.
9. Do not defeat the safety purpose of a polarized or grounding-type plug. A polarized plug has two blades with one wider than the other. A grounding type plug has two blades and a third grounding prong. The wide blade or the third prong are provided for your safety. If the provided plug does not fit into your outlet, consult an electrician for replacement of the obsolete outlet.
10. Protect the power cord from being walked on or pinched particularly at plugs, convenience receptacles, and the point where they exit from the product.
11. Only use attachments/accessories specified by Atlona.
12. To reduce the risk of electric shock and/or damage to this product, never handle or touch this unit or power cord if your hands are wet or damp. Do not expose this product to rain or moisture.
13. Unplug this product during lightning storms or when unused for long periods of time.
14. Refer all servicing to qualified service personnel. Servicing is required when the product has been damaged in any way, such as power-supply cord or plug is damaged, liquid has been spilled or objects have fallen into the product, the product has been exposed to rain or moisture, does not operate normally, or has been dropped.



FCC Compliance

FCC Compliance and Advisory Statement: This hardware device complies with Part 15 of the FCC rules. Operation is subject to the following two conditions: 1) this device may not cause harmful interference, and 2) this device must accept any interference received including interference that may cause undesired operation. This equipment has been tested and found to comply with the limits for a Class A digital device, pursuant to Part 15 of the FCC Rules. These limits are designed to provide reasonable protection against harmful interference in a commercial installation. This equipment generates, uses, and can radiate radio frequency energy and, if not installed or used in accordance with the instructions, may cause harmful interference to radio communications. However there is no guarantee that interference will not occur in a particular installation. If this equipment does cause harmful interference to radio or television reception, which can be determined by turning the equipment off and on, the user is encouraged to try to correct the interference by one or more of the following measures: 1) reorient or relocate the receiving antenna; 2) increase the separation between the equipment and the receiver; 3) connect the equipment to an outlet on a circuit different from that to which the receiver is connected; 4) consult the dealer or an experienced radio/TV technician for help. Any changes or modifications not expressly approved by the party responsible for compliance could void the user's authority to operate the equipment. Where shielded interface cables have been provided with the product or specified additional components or accessories elsewhere defined to be used with the installation of the product, they must be used in order to ensure compliance with FCC regulations.

Copyright, Trademark, and Registration

© 2024 Atlona Inc. All rights reserved. "Atlona" and the Atlona logo are registered trademarks of Atlona Inc. Pricing, specifications and availability subject to change without notice. Actual products, product images, and online product images may vary from images shown here.

HDMI™ The terms HDMI, HDMI High-Definition Multimedia Interface, HDMI trade dress and the HDMI Logos are trademarks or registered trademarks of HDMI Licensing Administrator, Inc.

All other trademark(s), copyright(s), and registered technologies mentioned in this document are the properties of their respective owner(s).

Table of Contents

Introduction	7
Features	7
Package Contents	7
Panel Description	8
Installation	9
Connection Instructions	9
Mounting Instructions	9
Wall Mount Installation	9
Ceiling Mount Installation	10
Connection Diagram	11
Device Operation	12
Initialization Procedure	12
Home Position	13
Field of View	14
Sample Calculations Table	14
Calculating Specific Values	15
Controlling the Camera	16
Tilt	16
Pan (Rotation)	16
Tilt and Pan Combinations	17
Zoom	18
Focus	18
Backlight Compensation (BLC)	19
Standby Mode	19
Managing Presets	20
Saving Presets	20
Clearing a Preset	20
Recalling Presets	20
Multiple Camera Control	21
Assigning / Changing the Camera Address ID	21
Selecting a Camera for Control	21
Network Streaming	22
Video Stream Configuration	22
RTMP Publishing	25
RTP Multicast	26
Configuration and Management Interfaces	27
Web Server	27
Registration	27
Logging In	28
Status Page	29
Firmware Page	30
System Page	31
Network Page	33
User Page	35
Encoding Page	36
Publishing Page	38
RTP Multicast Page	39
Reset Page	40
Picture Page	41
Focus Page	43
Exposure Page	44
Style Page	46
OSD Page	47
Video Out Page	48
Control Page	49

Table of Contents

IR Remote and OSD	50
IR Remote Control	50
OSD	50
Remote Functions	52
Appendix	53
Using VLC Player	53
Using Facebook Live	55
Using YouTube Live	58
Specifications	63

Introduction

The Atlona AT-HDVS-CAM-HDMI is an enterprise-grade PTZ camera designed for use in video conferencing and other applications such as lecture capture and distance education. It features HDMI output, as well as a USB 2.0 interface for video and camera control. Simultaneous video output is available through two interfaces. Through USB, the HDVS-CAM-HDMI seamlessly integrates with the Omega™ Series for a complete, automated conferencing system that includes AV and USB extension. The HDMI output is ideal for use with a video conferencing codec, lecture capture appliance, or PC equipped for video capture. The HDVS-CAM-HDMI delivers high performance, professional-quality imaging with video resolutions up to 1080p @ 60 Hz over HDMI and 1080p @ 30 Hz for USB 2.0, as well as fast and accurate auto-focusing, and a fast yet quiet pan and tilt mechanism. Also available is H.264 or H.265 streaming over IP with support for RTMP and RTSP protocols. This PTZ camera is ideal for a wide range of small to medium-sized meeting spaces, classrooms, training rooms, and many other environments. The HDVS-CAM-HDMI is available in black or white.

Features

- Designed for video conferencing and other applications such as lecture capture and distance education.
- HDMI output.
- USB 2.0 interface for video and camera control.
- Simultaneous video output over HDMI and USB.
- Universal PC compatibility through standard UVC 1.1 (USB Video Class) driver.
- Works with popular soft codec and UC clients such as Microsoft® Teams, Zoom™, BlueJeans™, Slack™, WebEx®, and GoToMeeting®.
- Up to 255 camera presets available, 10 accessible from IR remote.
- Supports VISCA, Pelco-D, and Pelco-P camera control protocols.
- H.264 and H.265 video over IP network streaming available, with support for RTMP and RTSP protocols.
- Fast and accurate auto focus, plus auto white balance and auto exposure modes.
- Fast and quiet pan and tilt mechanism.
- Picture controls available for brightness, color, saturation, contrast, sharpness, and gamma.
- Easy, GUI-based configuration using integrated web server.
- TCP/IP, RS-232, USB, and IR control – convenient handheld IR remote control included.
- Delivers HD video resolutions including 1080p @ 60 Hz (176x144 up to 1080p @ 30 Hz over USB 2.0).
- High performance imaging, fine detail, and color rendering with 1/2.8" low-noise, HD CMOS sensor.
- Multi-element zoom lens with 10x optical zoom and a 60.9° horizontal field of view.
- Camera can be mounted on a wall, or inverted for ceiling installation with the **optional** AT-HDVS-CAM-CMNT ceiling mount kit.
- Includes installation guide, wall mounting bracket, IR remote control, 2 meter (6.5 foot) USB Type-A male to male cable, VISCA to RS-232 DB-9 adapter, lens cap, and external universal power supply.
- Available in black or white.

Package Contents

- 1 x AT-HDVS-CAM-HDMI-BK or AT-HDVS-CAM-HDMI-WH
- 1 x Wall mounting plate
- 1 x 1/4 200UNC screws
- 1 x IR Remote Control
- 1 x USB A cable
- 1 x VISCA to RS-232 DB-9 adapter
- 2 x AAA battery
- 1 x 12 V DC power supply
- 1 x Installation Guide

Panel Description

Front (AT-HDVS-CAM-HDMI-WH shown)

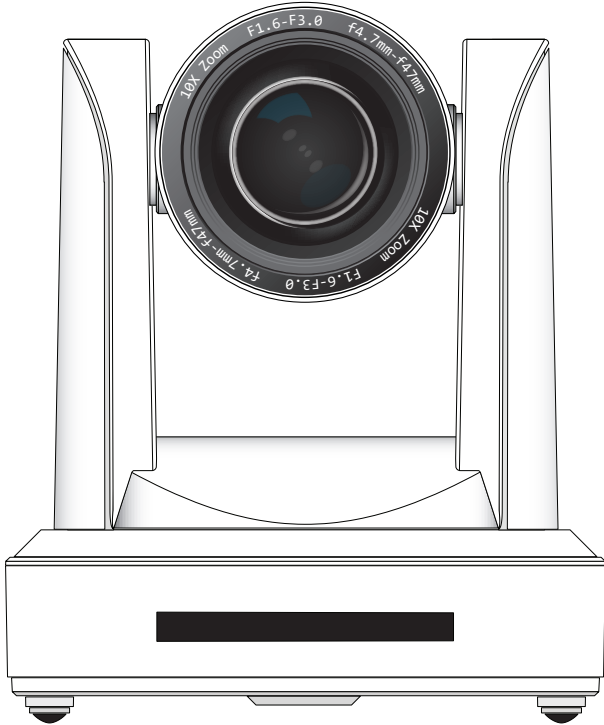

Back (AT-HDVS-CAM-HDMI-BK shown)



1. RS-232

Connect included VISCA to RS-232 adapter here to control the camera with a third party software or hardware controller.

2. USB

Connect USB A cable from this port to the USB port of a conferencing system or USB extender such as AT-OME-EX-RX, AT-OME-SR21, etc.

3. HDMI OUT

Connect to an HDMI device such as a video conference codec or PC.

4. LAN

Connect to a network switch to control the unit via TCP/IP or webGUI.

5. DC 12V

Connect the included 12V power supply to this port.

Installation

Connection Instructions

1. Connect the included DC 12V power cable to the AT-HDVS-CAM-HDMI.
2. Connect the Ethernet cable to the LAN port on the back of the AT-HDVS-CAM-HDMI.
3. Connect the USB port of a conferencing system or USB extender such as AT-OME-EX-RX.
4. Connect to an HDMI cable from the HDMI port to a video conference codec or PC.
5. *Optional* Connect the Visca to RS-232 cable to the Visca port for RS-232 control. Note that RS-232 can also be connected to an AT-OME-RX11 or other receiver that supports RS-232 for remote control.

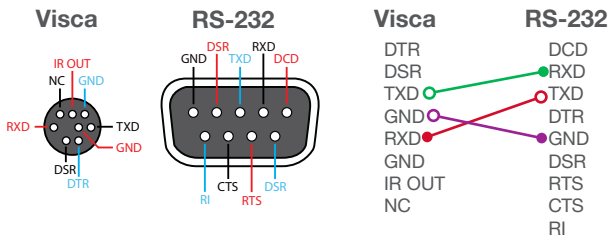

IMPORTANT: Never disconnect power from the USB host device during operation. Disconnecting the power from the USB host can cause video instability.

Mounting Instructions

The AT-HDVS-CAM-HDMI has two installation options, wall mount (included) and ceiling mount (purchased separately).

Wall Mount Installation

Install the AT-HDVS-CAM-HDMI, 4 M6 swelling bolts, 1 1/4 20 UNC bolt, 4 M6 nuts & shims, the included wall mount bracket, and the AT-HDVS-CAM-HDMI are needed.

1. Install the M6 swelling bolts in a rectangular pattern on the wall, 100 mm wide and 50 mm high.
2. Attached the wall mount bracket onto the wall, by placing them on the M6 swelling bolts and securing it with the M6 nuts and shims.
3. Once the wall mount bracket is secure on the wall, place the camera on the top of the wall mount bracket and secure it with the 1/4 20 UNC bolt.

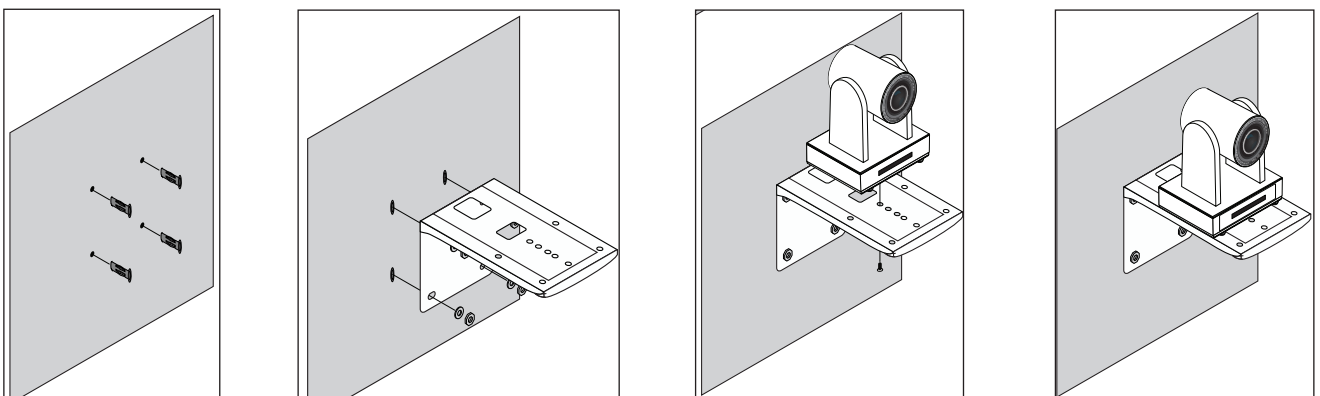

Ceiling Mount Installation

To install the AT-HDVS-CAM-HDMI, 4 PA3X30 self-tapping screws, 4 PM3X6 screws, 4 screw stoppers, 1 1/4 20 UNC screw, the optional ceiling upper and lower covering plates, and the AT-HDVS-CAM-HDMI are needed.

1. Install the 4 screw stoppers in the ceiling.
2. Connect the upper ceiling covering plate to the screw stoppers using the PA3X30 self-tapping screws.
3. Connect the lower ceiling covering plate to the bottom of the AT-HDVS-CAM-HDMI using the 1/4 20 UNC screw.
4. Mount the lower ceiling covering plate to the upper ceiling plate using 3 PM3X6 bolts.

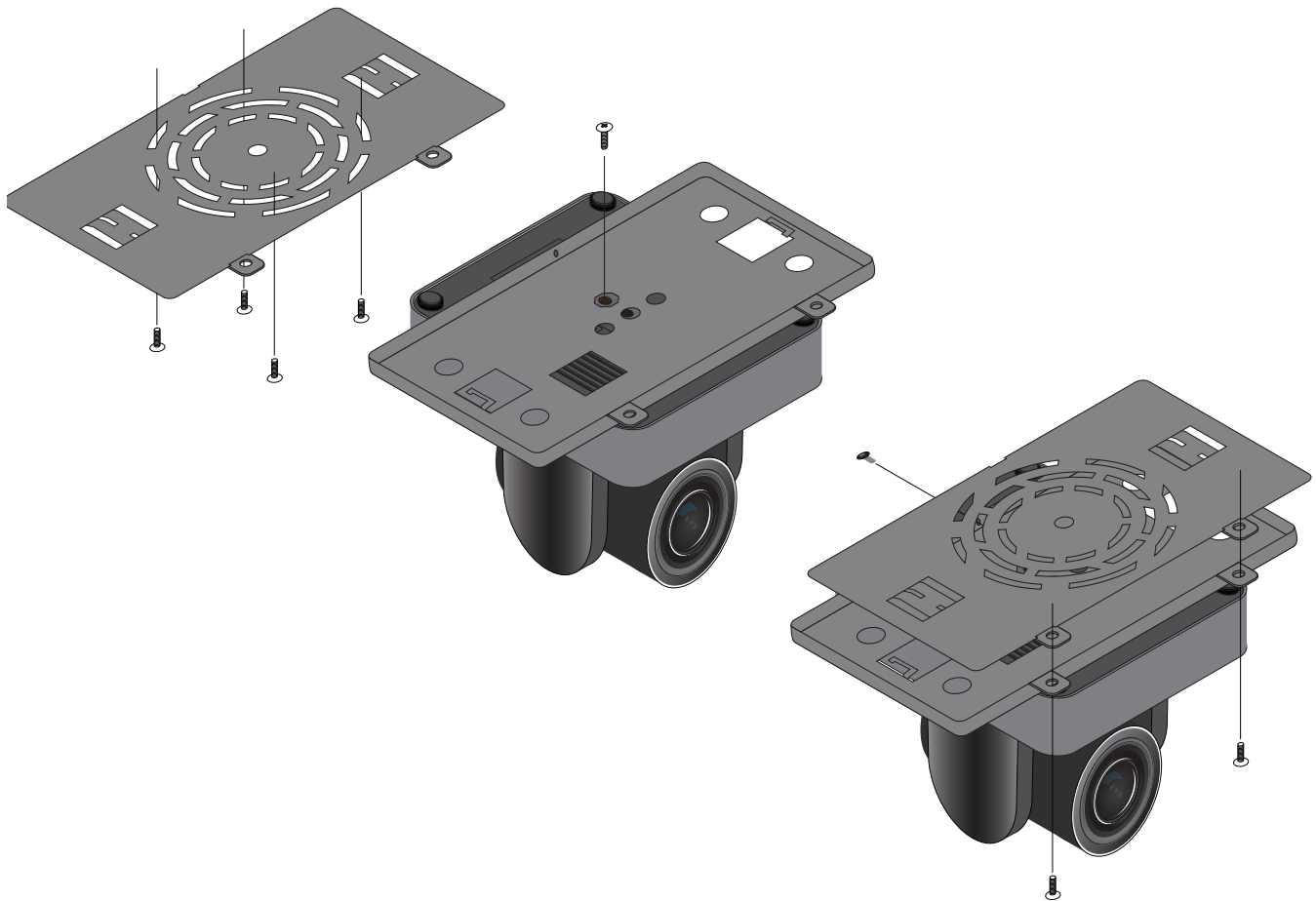

 **NOTE:** The camera picture will need to be inverted for video to be viewed correctly.

Connection Diagram

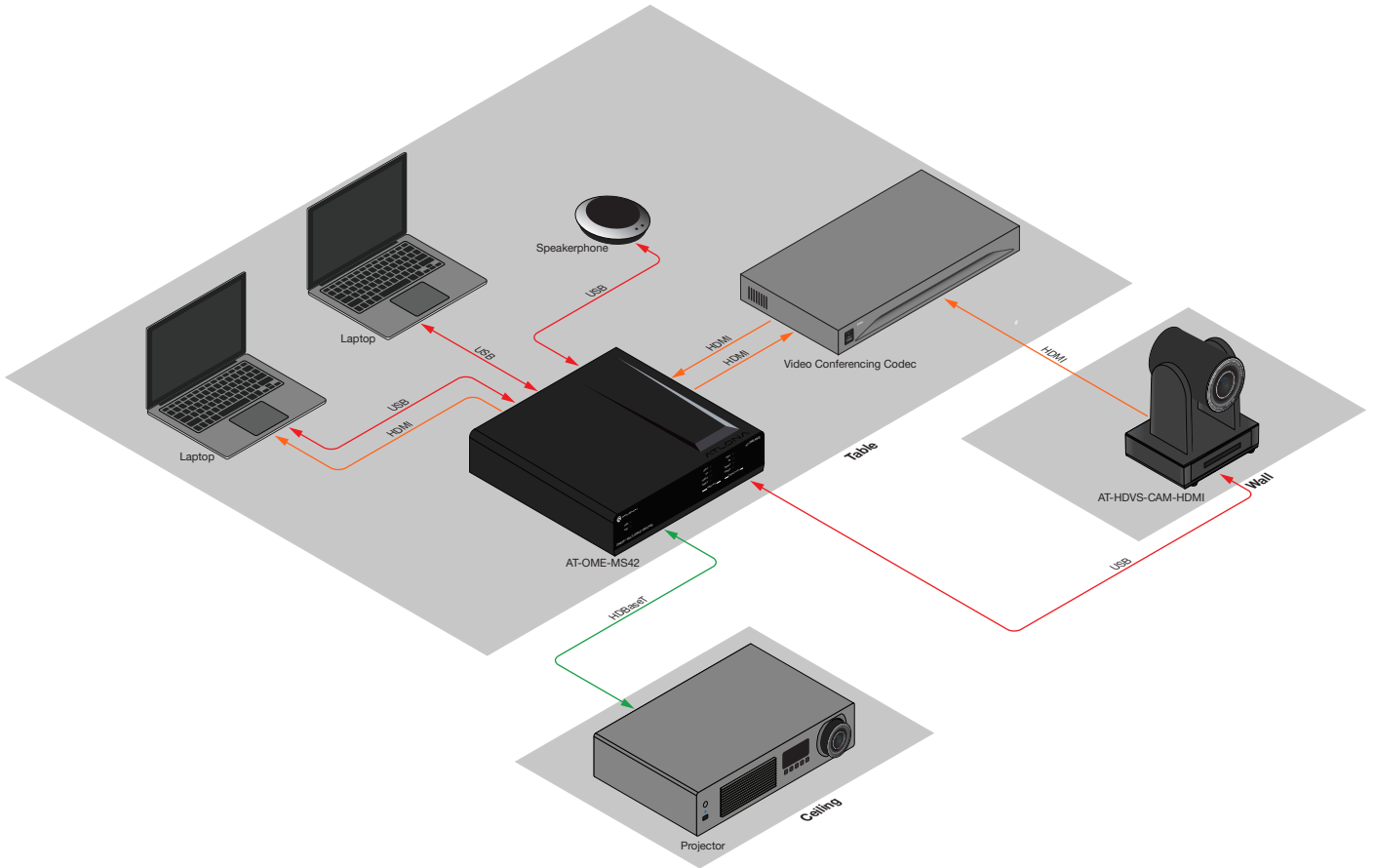

Device Operation

Initialization Procedure

Once the AT-HDVS-CAM-HDMI is powered, the camera will go through an initialization procedure. During this process, a flashing red LED indicator will be displayed. When the AT-HDVS-CAM-HDMI is ready for use, the LED indicator on the front panel will be solid green. The AT-HDVS-CAM-HDMI will repeat this process each time it is powered on.



Flashing red LED during initialization



Camera "ready" state

1. Starting position.
2. Connect the included 12 V DC power supply. The camera will rotate approximately 180 degrees. Camera lens assembly will be tilted forward, approximately 45 degrees, during the initialization process.
3. The camera then returns to its starting position. Once in this position, the camera lens will zoom-in as part of the initialization process.
4. Camera will rotate 90 degrees.
5. Camera returns to the starting position and the camera lens tilt setting will be set to 0 degrees.

Home Position

“Home” position is a term that is used throughout this manual. When the AT-HDVS-CAM-HDMI is in home position, the camera is facing forward and has no tilt angle, as shown in the illustration below:



Front



Left Side

Field of View

When positioning the camera in a huddle room or similar area, it will be helpful to know the viewing area of the camera, based on a fixed target. The viewable area of the camera is called the *linear field of view* or sometimes referred to as the *image plane*.

The illustration below shows the AT-HDVS-CAM-HDMI pointed at a fixed target.

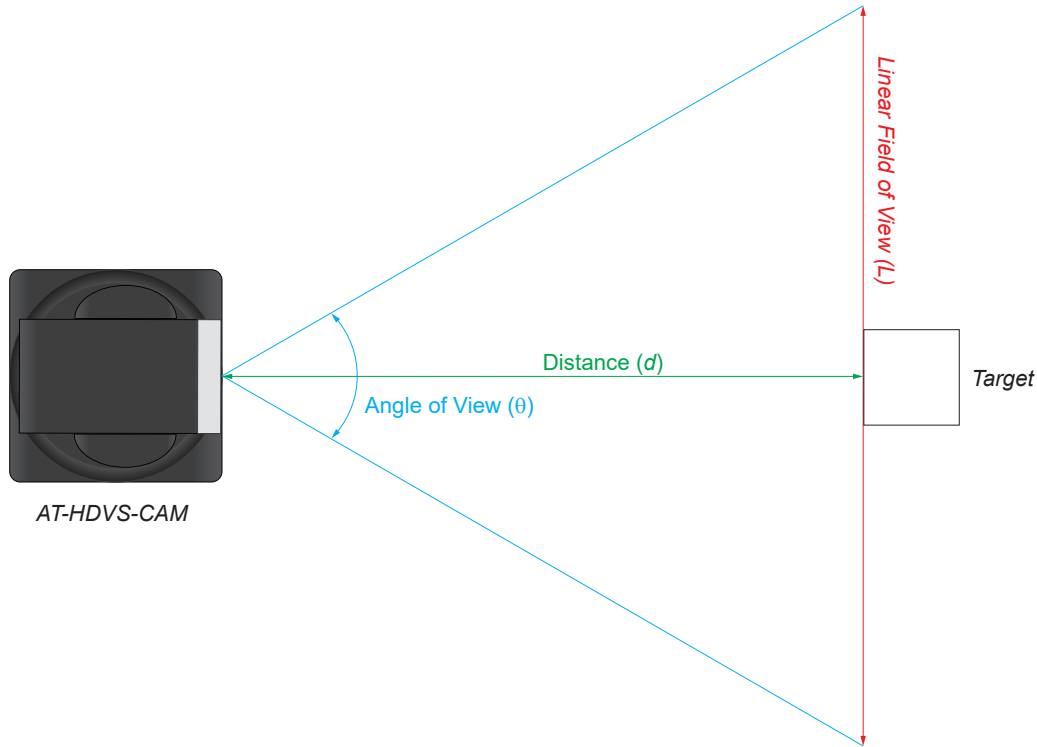

Sample Calculations Table

The following table provides a list of predefined distances, which the camera must be placed from the target, in order to capture the required Linear Field of View (L). The Angle of View, for the camera, has been set to 60.9° (wide-angle).

To calculate custom values, refer to [Calculating Specific Values \(page 15\)](#).

Angle of View (θ), in degrees	Distance (d), in feet	Linear Field of View (L), in feet
60.9°	5	5.875076864
	10	11.75015373
	15	17.62523059
	20	23.50030746
	25	29.37538432

Calculating Specific Values

In order to calculate custom values, this section introduces some trigonometric formulas which can be used to find the Linear Field of View (L), Distance (d), or the Angle of View (θ). The derivation of each formula is beyond the scope of this manual. As long as any two values are known, the third value can be calculated as follows:

Linear Field of View (FOV)

$$L = 2 \cdot d \cdot \tan\left(\frac{\theta}{2}\right)$$

Angle of View

$$\theta = 2 \cdot \arctan\left(\frac{L}{2 \cdot d}\right)$$

Distance to target

$$d = \frac{L}{2 \cdot \tan\left(\frac{\theta}{2}\right)}$$

NOTE: When calculating the Angle of View, using a calculator that is set to radians, multiply the result by $\frac{\pi}{180}$ to convert the answer to degrees. The value of π can be approximated as 3.1415.

Example

In the following diagram, the camera angle of view is set to 54.7° . The viewing area to be captured is measured to be 9 feet. How far from the target must the camera be placed in order to capture this area?

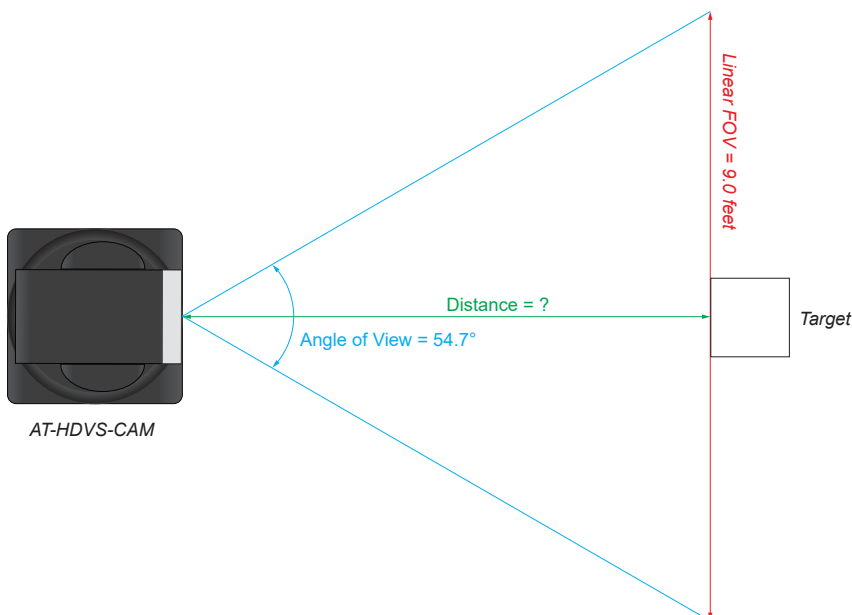

- Use the following formula: $d = \frac{L}{2 \cdot \tan\left(\frac{\theta}{2}\right)}$
- Substitute the known values for each variable in the equation. In this case, we know both the linear FOV and the angle of view. Therefore:
 $L = 9$
 $\theta = 54.7$
- The equation becomes: $d = \frac{9}{2 \cdot \tan\left(\frac{54.7}{2}\right)}$
- $\tan\left(\frac{54.7}{2}\right) = 0.5172$
- Multiplying this result by 2 gives: 1.0344
- Dividing 9 by 1.0344 , yields: 8.700 . Therefore, the camera must be placed 8.7 feet from the target.

Controlling the Camera

The AT-HDVS-CAM-HDMI can be controlled using the included IR remote control, RS-232, TCP/IP, or through the webGUI. Refer to the [WebGUI \(page 17\)](#) for more information about accessing the webGUI.

Tilt

The camera tilt range is approximately -45 degrees to +90 degrees. Use one of the following methods to adjust the camera tilt.

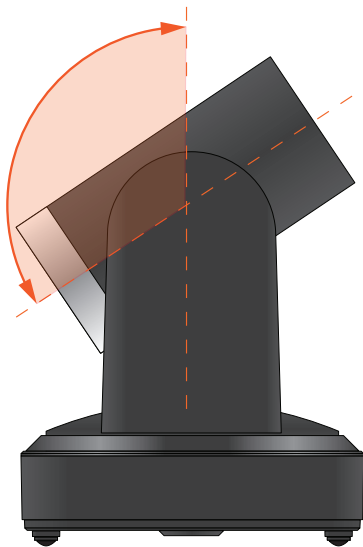

IR Remote Control

- Press and release the up or down arrow button to adjust the tilt of the camera in small increments.
- Press and hold the up or down arrow button to adjust the camera tilt at a faster rate.
- Press the **HOME** button to return the camera to the “home” position.

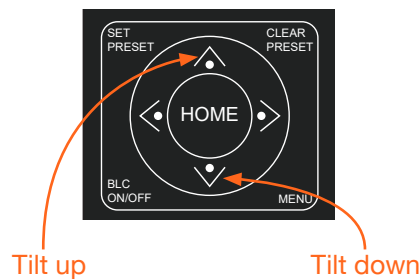

webGUI

1. Click **Control** in the side menu bar.
2. Click the up-arrow or down-arrow button to tilt the camera up or down, respectively.
3. Click the  icon in the center to return the camera to the “home” position.

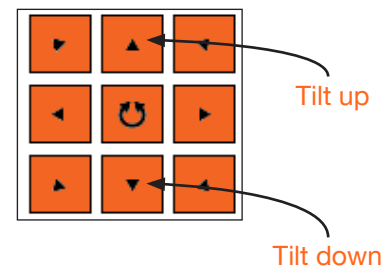

Pan (Rotation)

The camera pan range is approximately 360 degrees. Use one of the following methods to adjust the camera pan.

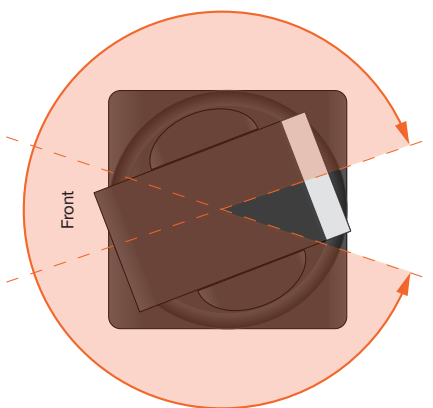

IR Remote Control

- Press and release the left or right arrow button to adjust the camera tilt in small increments.
- Press and hold the left-arrow or right-arrow button to adjust the camera tilt at a faster rate.
- Press the **HOME** button to return the camera to the “home” position.

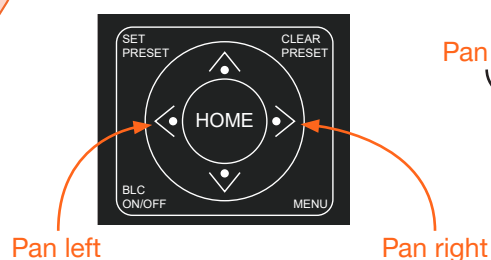

webGUI

1. Click **Control** in the side menu bar.
2. Click the left arrow or right arrow button to tilt the camera up or down, respectively.
3. Click the  icon in the center to return the camera to the “home” position.

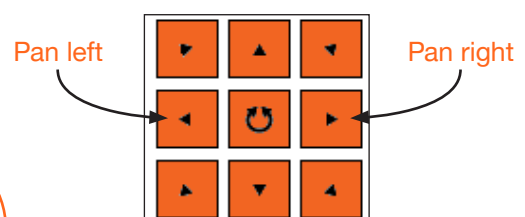

Tilt and Pan Combinations

The webGUI provides a method for combining both tilt and pan motion. Note that this function is *not* available on the included IR Remote Control.

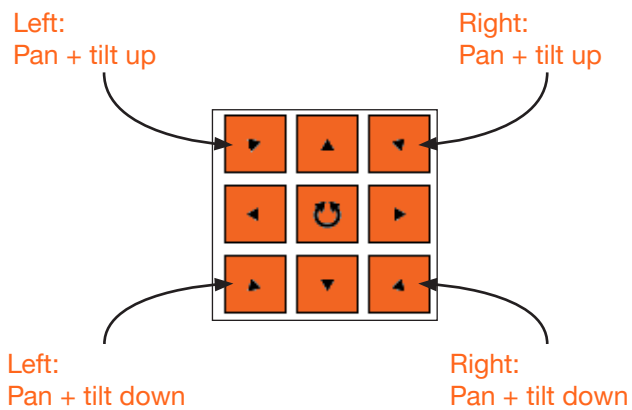
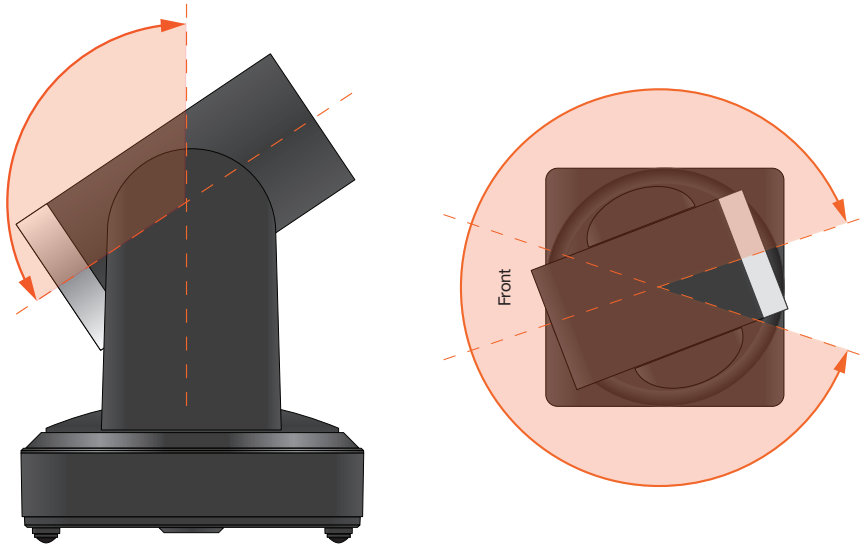

webGUI (only)

1. Click **Control** in the side menu bar.
2. Click the diagonal arrow buttons to simultaneously tilt and pan the camera in the desired direction:
 - **Upper Diagonal-left arrow**
Pans and rotates camera up and to the left.
 - **Lower Diagonal-left arrow**
Pans and rotates camera down and to the left.
 - **Upper Diagonal-right arrow**
Pans and rotates camera up and to the right.
 - **Lower Diagonal-right arrow**
Pans and rotates camera down and to the right.
3. Click the  icon in the center to return the camera to the “home” position.

Zoom

The camera provides a zoom factor up to 10x. Use one of the following methods to adjust the camera zoom.

IR Remote Control

- Locate the **ZOOM** rocker switch on the IR Remote Control.
- Press and release + to zoom-in or press - to zoom-out.
- Press and hold these buttons to zoom-in or zoom-out at a faster rate.

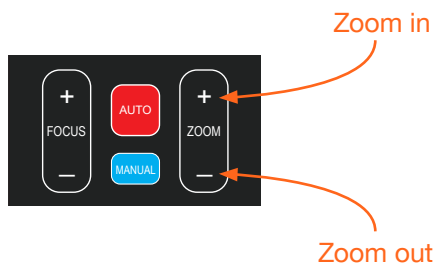

webGUI

1. Click **Control** in the side menu bar.
2. Click + to zoom-in or click - to zoom out.



Focus

When positioning the camera on an object, it may be necessary to adjust the focus for a clear image. The AT-HDVS-CAM-HDMI can be set to auto focus or manual focus. By default, the AT-HDVS-CAM-HDMI is set to auto-focus mode.

NOTE: In order to manually control the focus, the AT-HDVS-CAM-HDMI must be in manual focus mode. Press the **MANUAL** button to enter manual focus mode.

IR Remote Control

- Press and release the **MANUAL** button.
- Locate the **FOCUS** rocker switch on the IR Remote Control.
- Press and release + to increase focus on objects in the foreground. Press and release the - to focus on objects in the background.
- Press and hold these buttons to adjust the focus at a faster rate.

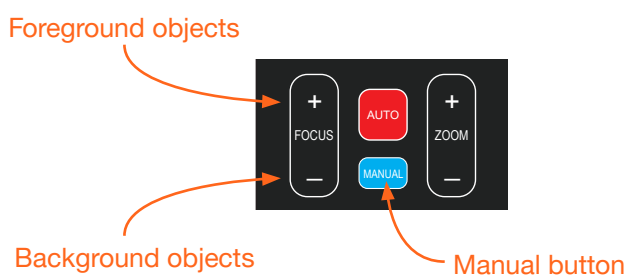

webGUI

1. Click **Control** in the side menu bar.
2. Set the AT-HDVS-CAM-HDMI to manual focus mode by selecting **Manual** from the **Focus Mode** drop-down list.
3. Click + to focus on foreground objects or click - to focus on background objects.

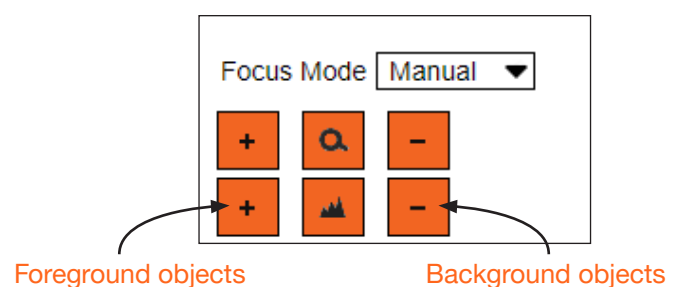

Backlight Compensation (BLC)

BLC is a feature which automatically adjusts the exposure control of the camera. When enabled, BLC will attempt to increase the ambient foreground light and “darken” any background light. For example, a subject standing in front of a window in the daytime, will produce a silhouetted effect. Enabling BLC will compensate for the difference in lighting.

IR Remote Control

1. Point the IR Remote Control at the front of the AT-HDVS-CAM-HDMI.
2. Press and release the **BLC ON/OFF** button to toggle BLC on or off.

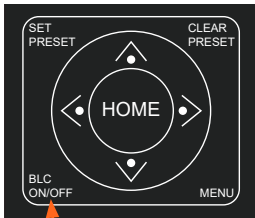

BLC on/off button

webGUI

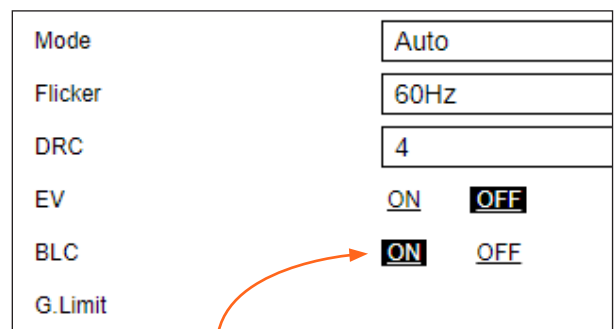

1. Click **Exposure** in the side menu bar.
2. Click ON to enable BLC. Click OFF to disable BLC.



BLC ON

Standby Mode

Placing the AT-HDVS-CAM-HDMI in standby mode will power-down the camera. Placing the camera in standby mode is managed using the IR Remote Control.

1. Point the IR Remote Control at the front of the AT-HDVS-CAM-HDMI.
2. Press and hold the  button for three seconds.
3. The camera will rotate 90 degrees and the camera lens assembly will tilt approximately 45 degrees. The camera is now in standby mode.
4. Press and hold the  button for three seconds to wake the camera. After the camera is awake, it will return to the home position.

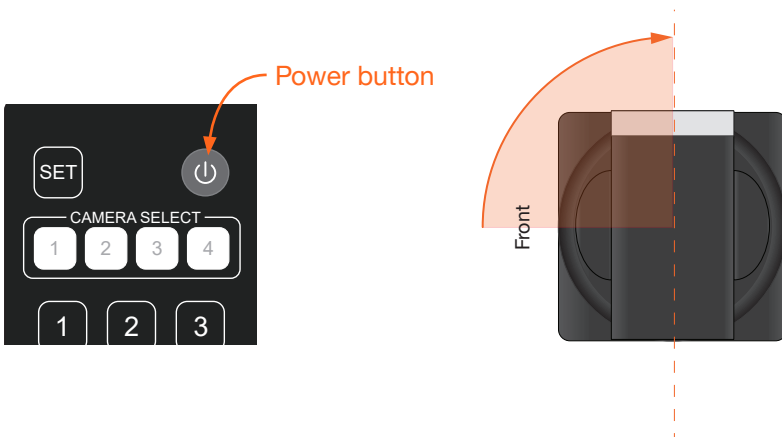

Power button



NOTE: The camera will always be set to the home position after this sequence is performed. To return the camera to the last position, either position it manually or recall the saved preset.

Managing Presets

Camera positions can be stored to local memory and recalled at a later time. Presets are stored and recalled using the included IR Remote Control. Up to 10 presets can be saved.

Saving Presets

1. Set the camera in the desired position.
2. Point the IR Remote Control at the front of the AT-HDVS-CAM-HDMI.
3. Press the **SET PRESET** button.
4. Press the desired number on the IR Remote Control keypad to assign the position of the camera to the preset.

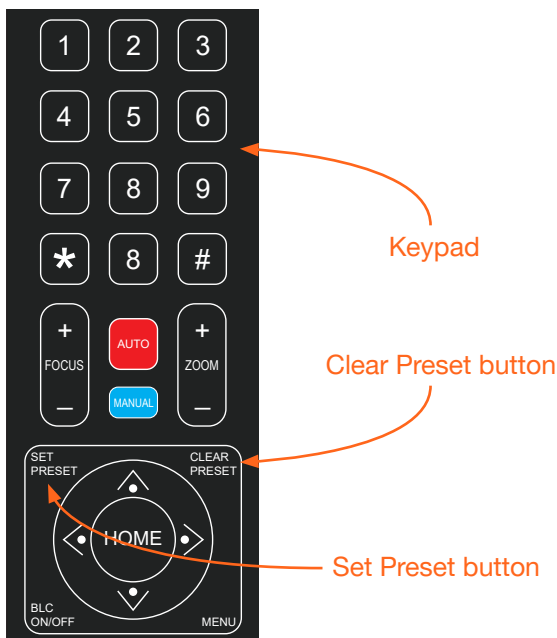

Clearing a Preset

Presets can be erased. It is not necessary to clear a preset, before saving a new camera position in the same preset. If a preset is saved to an existing preset, it will be overwritten.

1. Press the **CLEAR PRESET** button.
2. Press the desired number on the IR Remote Control keypad to clear the preset.

NOTE: To clear all presets, press and release the [#] key on the keypad, three times.

Recalling Presets

1. Point the IR Remote Control at the front of the AT-HDVS-CAM-HDMI.
2. Press the number of the desired preset from the IR Remote Control keypad.
3. The camera will be set to the position defined by the preset.

Multiple Camera Control

There may be environments where more than one camera is being used. The included IR remote control unit provides a way to select and control up to four separate cameras.

Assigning / Changing the Camera Address ID

Before the IR remote control unit can be used to control different camera, each camera must be assigned an address ID. It is possible to assign multiple cameras with the same ID. However, if all cameras are within close vicinity, IR remote control commands will be distributed to all cameras. This may not always be desirable.

1. Point the IR remote control at the front of the AT-HDVS-CAM-HDMI.
2. Assign the camera an ID by sequentially pressing the following series of buttons listed in the table below.

Camera Address ID	Keystrokes
1	[*] + [#] + [F1]
2	[*] + [#] + [F2]
3	[*] + [#] + [F3]
4	[*] + [#] + [F4]

3. Follow the above steps for each camera. Each camera can have a distinct ID. For cameras that have been assigned unique ID addresses, it may be helpful to place a label on each camera for future reference.

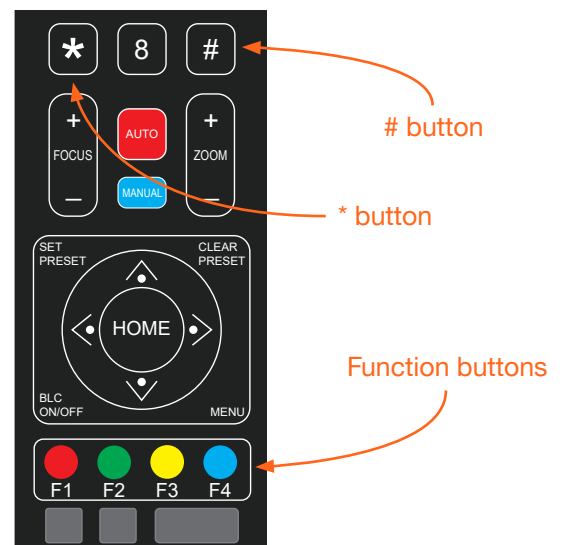

Selecting a Camera for Control

1. Point the IR remote control at the front of the desired AT-HDVS-CAM-HDMI.
2. Press the button of the camera ID, which is being controlled, within the **CAMERA SELECT** button group on the IR remote control.
3. Press the buttons on the IR remote control for the desired operation of the camera.

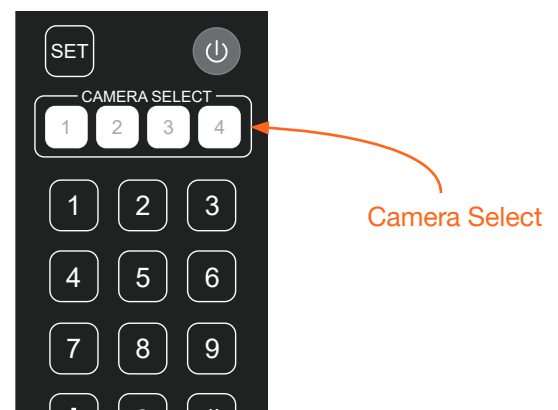

Network Streaming

This section covers video stream configuration, as well as RTMP publishing and RTP multicast. Refer to the [Appendix \(page 53\)](#) on how to configure streaming using VLC, Facebook Live, and YouTube Live.

Video Stream Configuration

1. Login to the web server.
2. Click **Encoding** in the side menu bar.
3. Under the **Video Encoding** section, select the encoding protocol by clicking **Enabled**, next to **RTSP** (Real Time Streaming Protocol) and **RTMP** (Real Time Messaging Protocol). Either or both protocols can be set to **Enabled**. When enabled, the checkbox will contain a check mark.

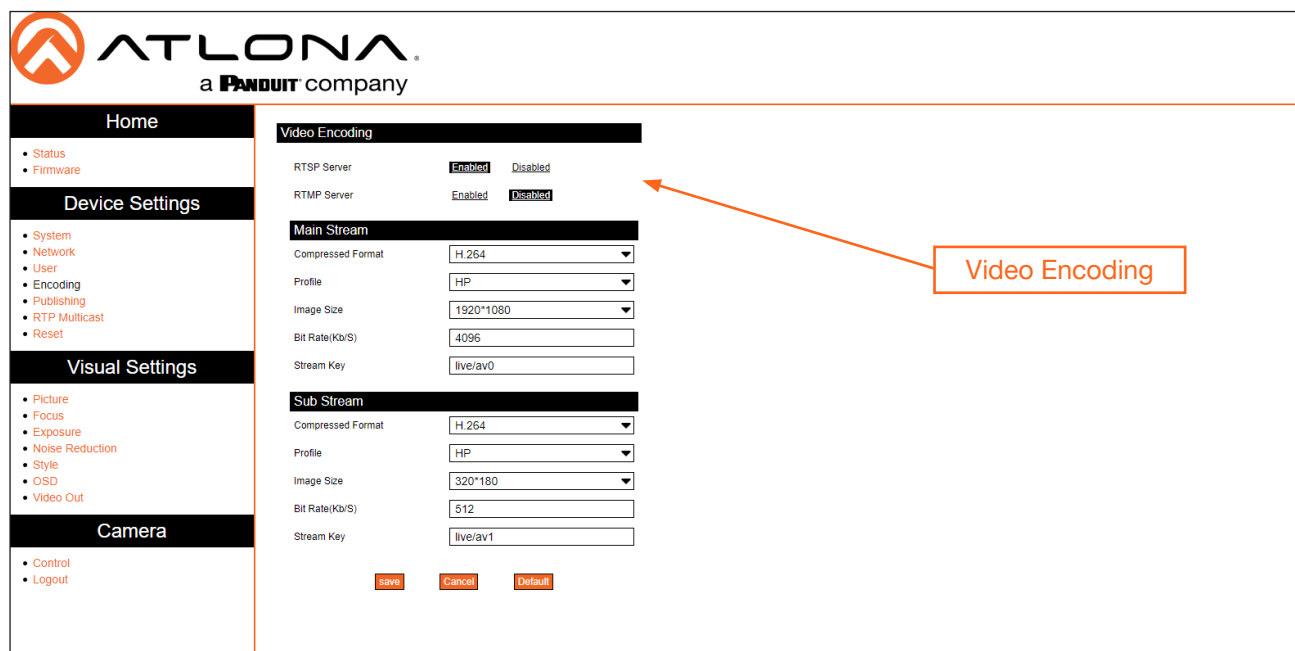

4. Under the **Main Stream** and **Sub Stream** sections, click each of the drop-down lists to assign the desired settings. Both **Main Stream** and **Sub Stream** are used to view the camera's footage.

Main Stream is the primary video feed and provides the highest quality video. **Main Stream** provides the highest video quality, and is the stream used by a digital recorder when saving footage to hard disk. Adjusting these settings will affect the recording size and available recording time on the hard disk.

Sub Stream is the secondary video feed and provides a lower quality video stream. This stream is used to stream video to computers and mobile devices. Adjusting these settings will affect the bandwidth of the stream.

Compressed Format

The desired encoding format

Format	Description
H.264 (AVC)	Advanced Video Codec - Industry-standard codec that provides good-quality compressed video output.
H.265 (HVEC)	High-Efficiency Video Coding - Provides a higher compression ratio than H.264, thus reducing the bandwidth necessary for high-resolution (2K/4K) video capture.

Profile

These options are only available when **H.264** is selected. Profiles are a set of encoding processes for H.264.

Profile	Description
BP	Baseline Profile - Supports a limited set of processes and is designed to meet the needs of mobile devices.
MP	Main Profile - Supports a good number of processes and is typically used for devices such as set-top boxes.
HP	High Profile - Supports all processes of H.264 and targets FullHD (1080p) applications such as Blu-ray and satellite streams.

Image Size

These resolutions are available for all codecs and profiles.

Resolution		
1920x1080	1280x720	640x480

Bit Rate (kb/s)

Enter the desired bit rate in this field.

Encoding Protocol	Bit Rate Range
H.264	64 ... 20480 kb/s
H.265	64 ... 40960 kb/s

Stream Key

Enter the stream key in this field. This key (code) is used to identify the stream, allowing the stream to be displayed on a web site.

Main Stream - Recommended Settings for H.264

Resolution	Bit Rate
1920x1080	4096 kb/s
1280x720	2048 kb/s

Sub Stream - Recommended Settings for H.264

Resolution	Bit Rate
640x480	1024 kb/s
640x360	1024 kb/s
320x240	512 kb/s
320x180	512 kb/s

5. Click the **Save** button to commit changes.
6. Click **Reset** in the side menu bar and click the **Reboot** button.

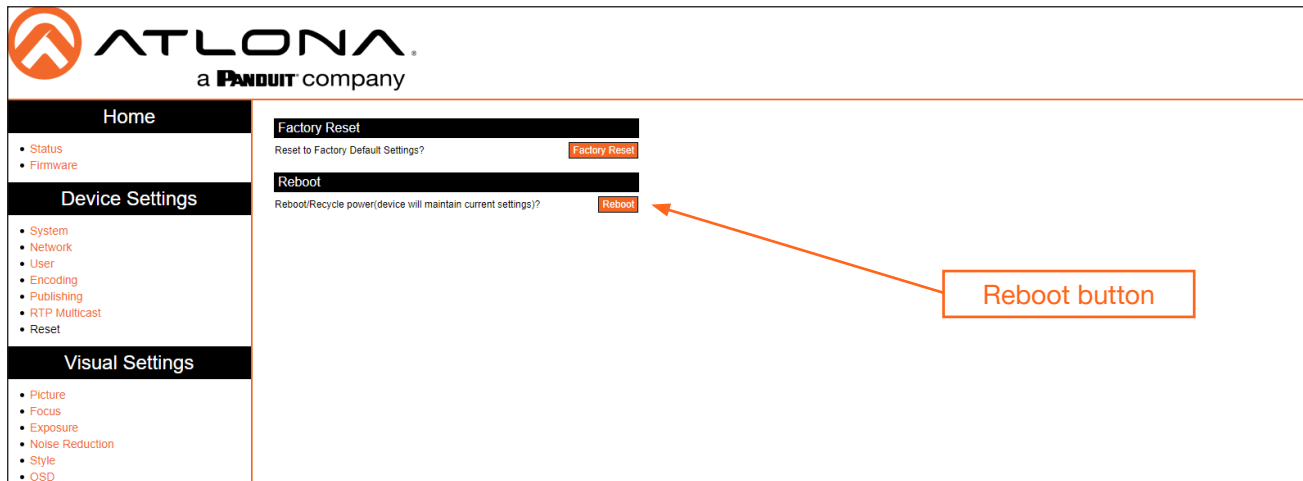

IMPORTANT: After settings have been updated, streams should be re-pulled and restarted to ensure best video quality. If the camera has been power-cycled, then it will be necessary to re-pull both RTMP and RTSP streams.

RTMP Publishing

In order to for the stream to be pushed to live-streaming platforms, such as YouTube™, Twitch®, and others, follow the procedure below.

1. Login to the web server.
2. Click **Publishing** in the side menu bar. **RTMP Server**, under the **Encoding** menu, should already be enabled. If not, please refer to [Video Stream Configuration \(page 22\)](#) for more information.
3. Click the **Enable** checkbox to enable the **Main Stream** and/or **Sub Stream**.

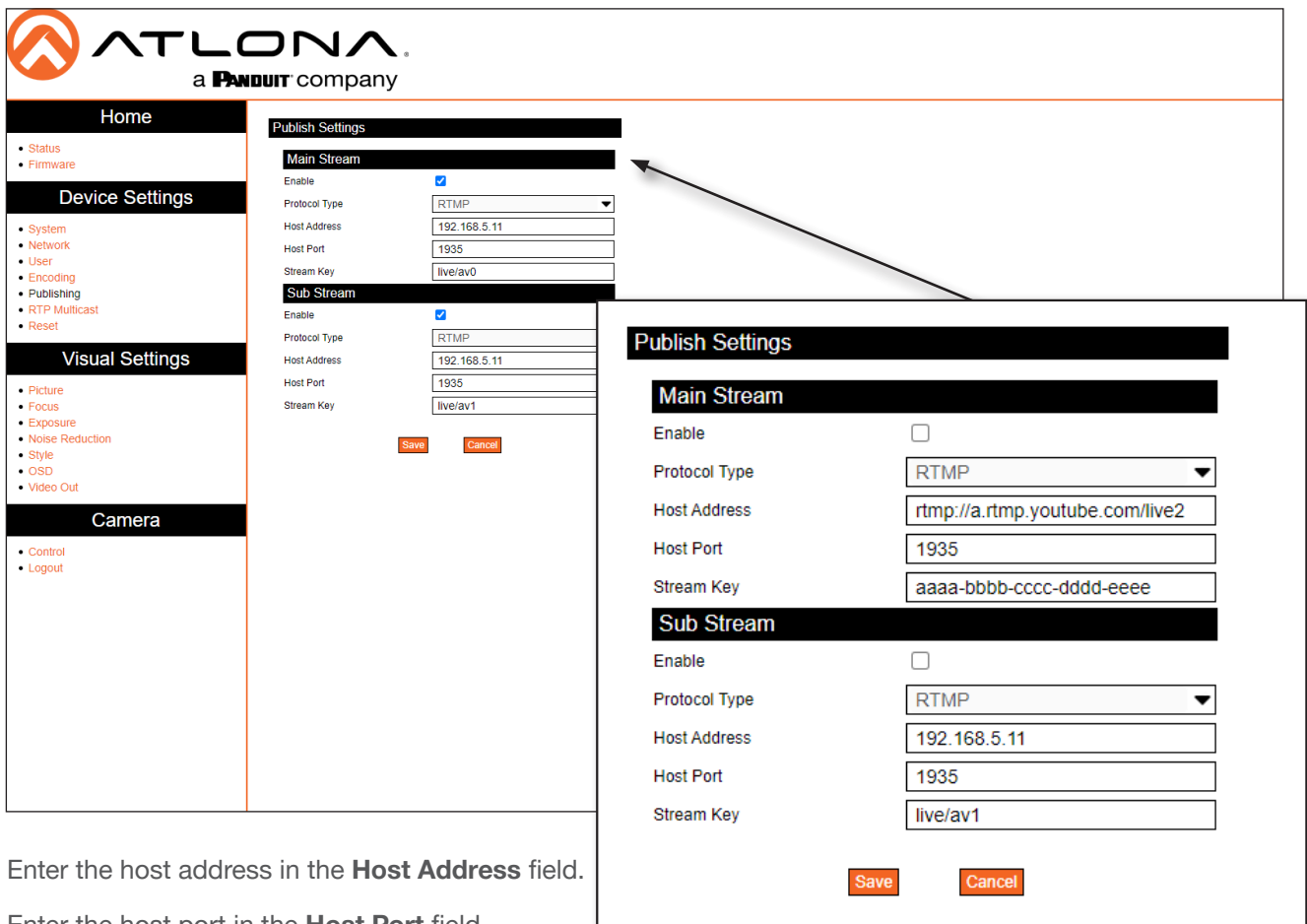

The screenshot displays the ATLONA web interface. On the left is a navigation menu with sections: Home (Status, Firmware), Device Settings (System, Network, User, Encoding, Publishing, RTP Multicast, Reset), Visual Settings (Picture, Focus, Exposure, Noise Reduction, Style, OSD, Video Out), and Camera (Control, Logout). The main content area is titled 'Publish Settings' and contains two sections: 'Main Stream' and 'Sub Stream'. Each section has an 'Enable' checkbox, a 'Protocol Type' dropdown menu (set to RTMP), and input fields for 'Host Address', 'Host Port', and 'Stream Key'. In the 'Main Stream' section, the 'Host Address' is '192.168.5.11', 'Host Port' is '1935', and 'Stream Key' is 'live/av0'. In the 'Sub Stream' section, the 'Host Address' is '192.168.5.11', 'Host Port' is '1935', and 'Stream Key' is 'live/av1'. An inset image provides a magnified view of the 'Main Stream' settings, with an arrow pointing to the 'Host Address' field which contains the value 'rtmp://a.rtmp.youtube.com/live2'. 'Save' and 'Cancel' buttons are visible at the bottom of both the main settings and the inset.

4. Enter the host address in the **Host Address** field.
5. Enter the host port in the **Host Port** field.
6. Enter the stream key in the **Stream Key** field. See inset image, above, for an example.
7. Click the **Save** button to commit changes.

RTP Multicast

In order to for the stream to be published to a multicast address, follow the procedure below.

1. Login to the web server.
2. Click **RTP Multicast** in the side menu bar.
3. Click the **Enable** checkbox to enable the **Main Stream** and/or **Sub Stream**. When enabled, the checkbox will contain a check mark.

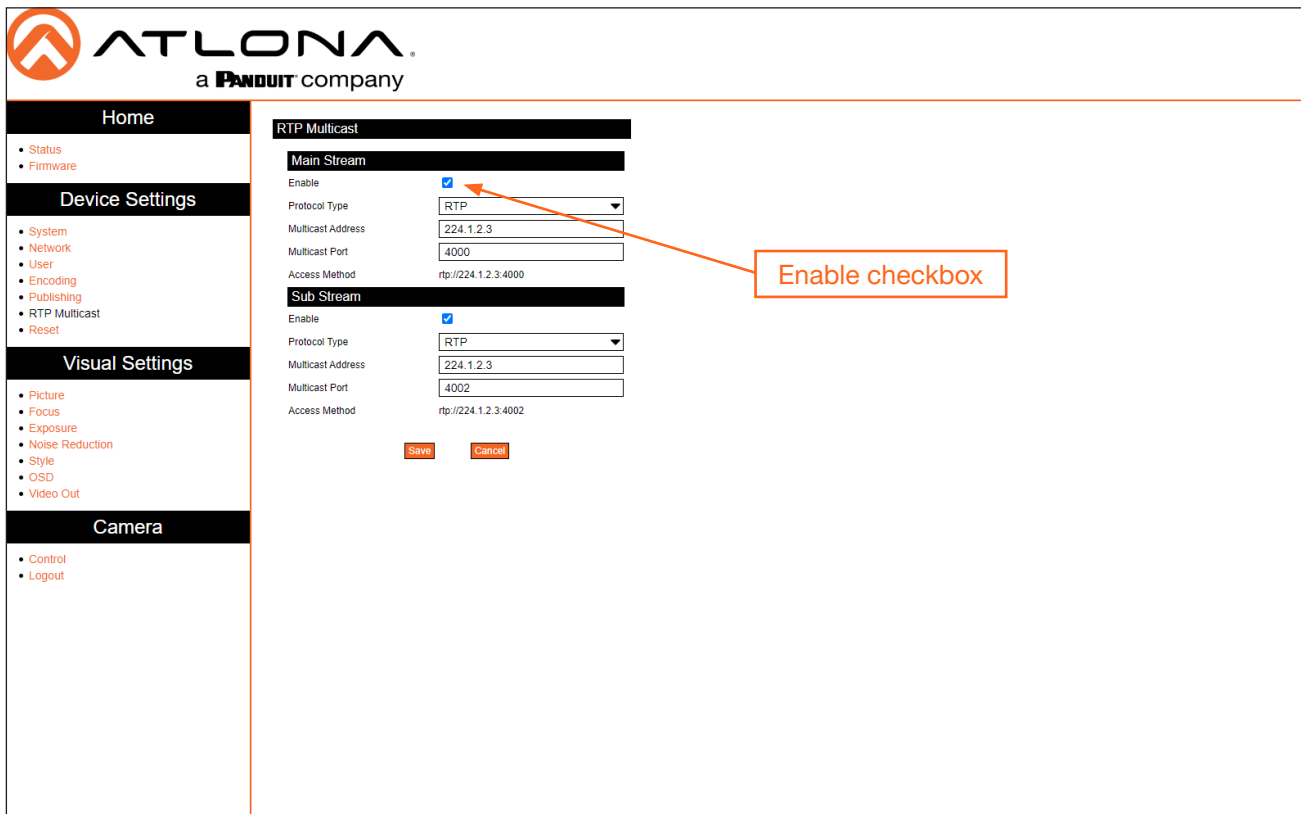

The screenshot shows the ATLONA web interface with the 'RTP Multicast' configuration page. The left sidebar contains navigation menus for 'Home', 'Device Settings', 'Visual Settings', and 'Camera'. The main content area is titled 'RTP Multicast' and contains two sections: 'Main Stream' and 'Sub Stream'. Each section has an 'Enable' checkbox, a 'Protocol Type' dropdown menu (set to 'RTP'), a 'Multicast Address' text input (set to '224.1.2.3'), a 'Multicast Port' text input (set to '4000'), and an 'Access Method' text input (set to 'rtp://224.1.2.3:4000'). At the bottom of the configuration area are 'Save' and 'Cancel' buttons. A red box highlights the 'Enable' checkbox in the 'Main Stream' section, with an orange arrow pointing to it from a label 'Enable checkbox'.

4. Click the **Protocol Type** drop-down list to select the protocol type. Enter the host port in the **Host Port** field.

Protocol	Description
RTP	Real Time Protocol
TS	Transport Stream (MPEG-TS)

5. Enter the multicast address in the **Multicast Address** field.
6. Enter the multicast port in the **Multicast Port** field.
7. Click the **Save** button to commit changes.

Refer to the next page for configuration examples.

Configuration and Management Interfaces

Web Server

Main operation of the AT-HDVS-CAM-HDMI is handled through the built-in web server. In order to access the web server, the IP address of the unit must be known.

Registration

1. Launch a desired web browser and enter the IP address of the AT-HDVS-CAM-HDMI in the address bar.
2. Enter the desired username in the **User Name** field. In the example below, the username `admin` is used.
3. Enter the desired password in the **Password** field. All passwords will be masked, when entered.



IMPORTANT: The password must contain a minimum of 8 characters, including: 1 uppercase character, 1 lowercase character, and 1 number.

4. Verify the password by entering it in the **Re-enter password** field.
5. Click the **Register** button.

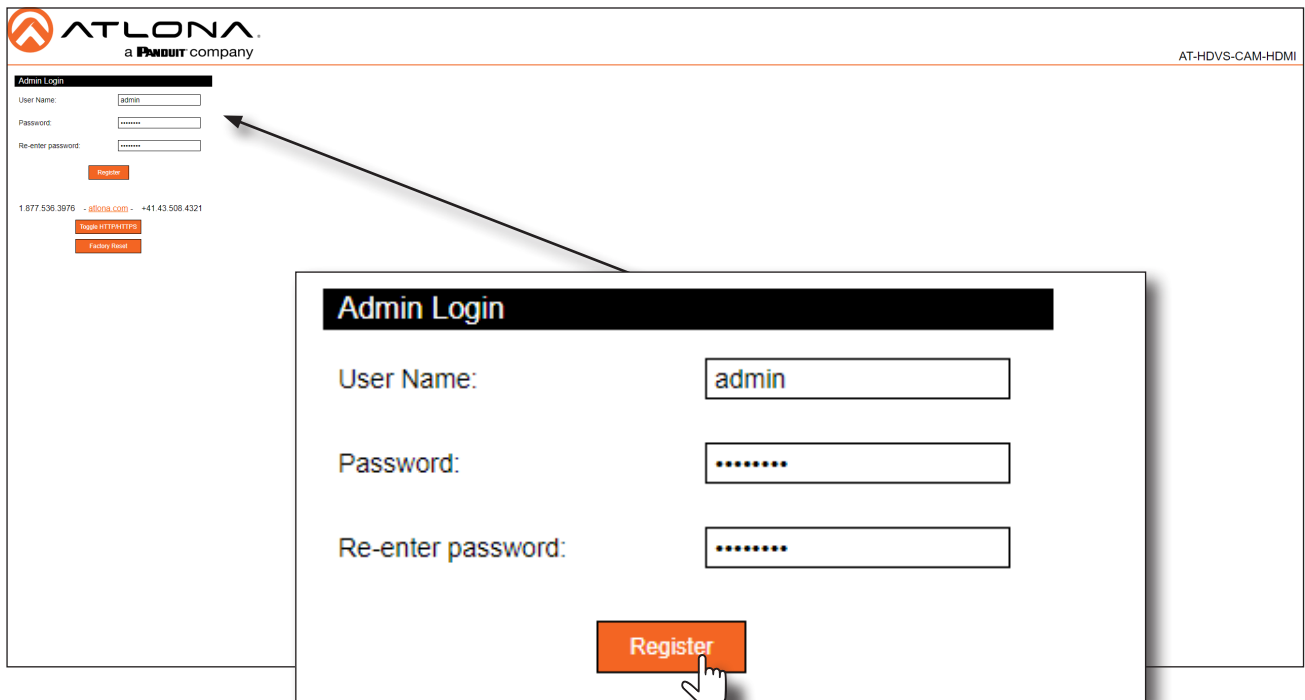

6. The **Login** page will be displayed.
7. Registration is complete.

Configuration and Management Interfaces

Logging In

Before logging in to the web server, make sure the registration process has been completed. Refer to [Registration \(page 27\)](#) for more information.

1. Launch the desired web browser and enter the IP address of the AT-HDVS-CAM-HDMI in the address bar.
2. Enter the correct username and password in the respective fields. To clear the **User Name** and **Password** fields, click the **Clear** button.



NOTE: If using a secure connection, click the **Toggle HTTP/HTTPS** button.

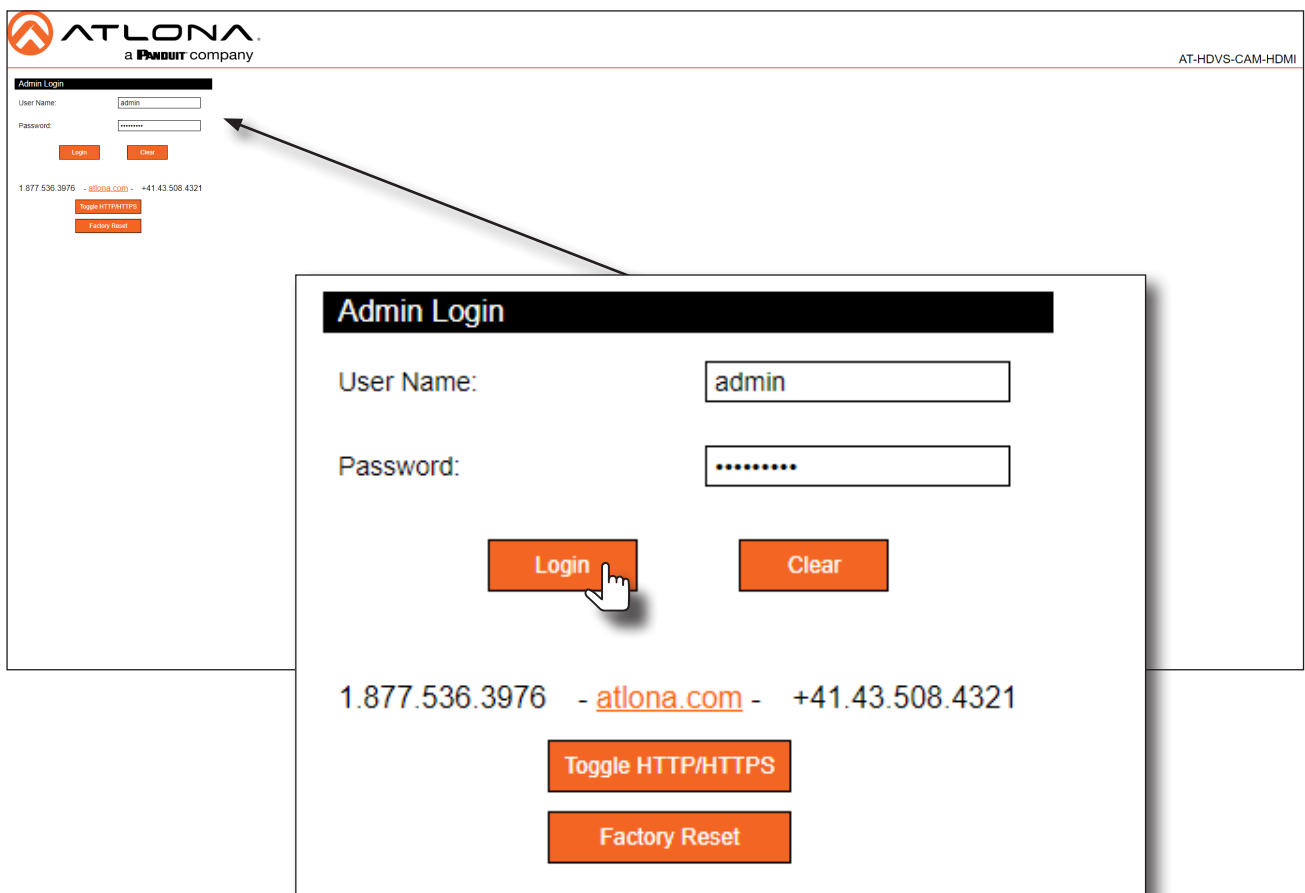

ATLONA
a PANOUT company

AT-HDVS-CAM-HDMI

Admin Login

User Name:

Password:

Login Clear

1.877.536.3976 - atlona.com - +41.43.508.4321

Toggle HTTP/HTTPS
Factory Reset

Admin Login

User Name:

Password:

Login Clear

1.877.536.3976 - atlona.com - +41.43.508.4321

Toggle HTTP/HTTPS
Factory Reset

3. Click the **Login** button.
4. The **Info** page will be displayed and the login process is complete.

Configuration and Management Interfaces

Status Page

The **Status** page provides basic information about the AT-HDVS-CAM-HDMI, including the software version.

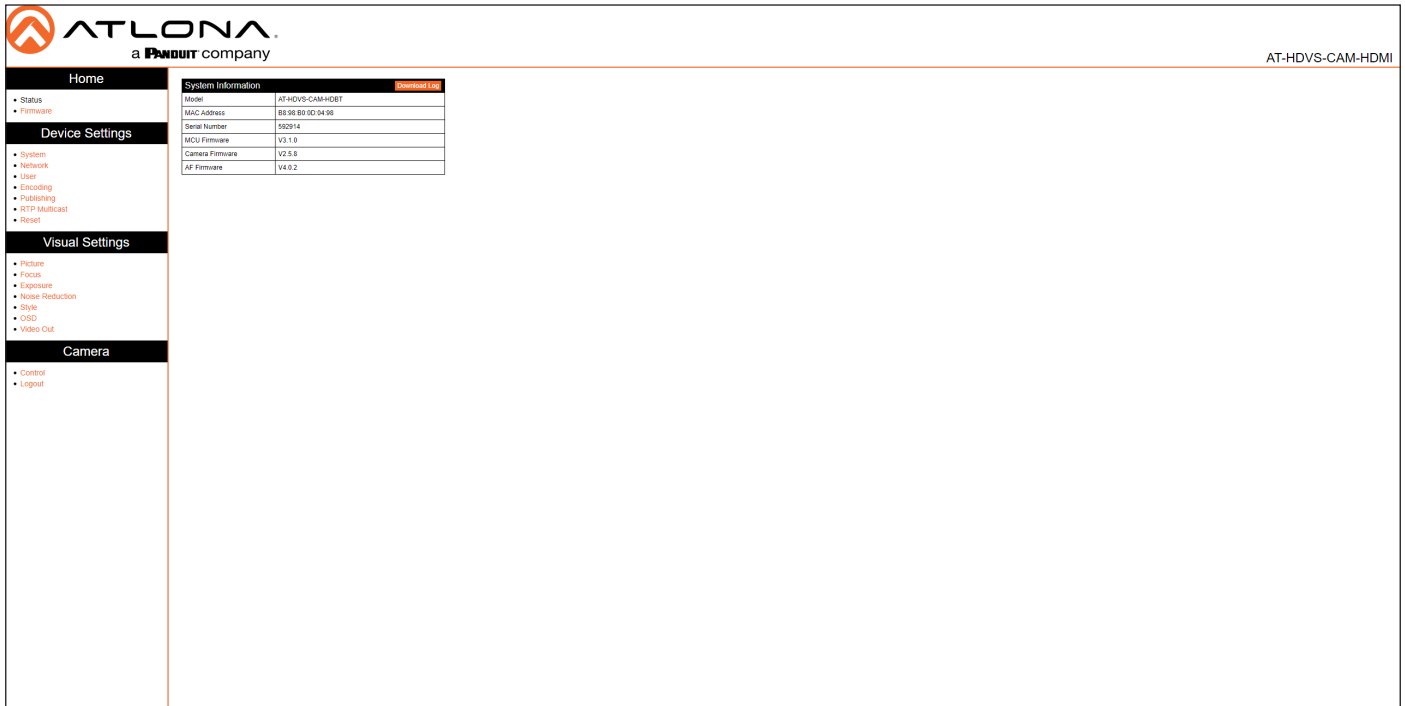

The screenshot shows the AT-HDVS-CAM-HDMI configuration interface. The top left corner features the ATLONA logo and the text 'a PANUIT company'. The top right corner displays 'AT-HDVS-CAM-HDMI'. The interface is divided into a left sidebar and a main content area. The sidebar contains navigation menus for 'Home', 'Device Settings', 'Visual Settings', and 'Camera'. The main content area displays 'System Information' with a 'Download Log' button. The System Information table is as follows:

System Information	
Model	AT-HDVS-CAM-HDMI
MAC Address	88:98:80:0D:04:08
Serial Number	562914
MCU Firmware	V3.1.0
Camera Firmware	V2.5.8
AF Firmware	V4.0.2

Model

The model of the unit.

MAC Address

The hardware MAC address of the unit.

Serial Number

The serial number of the unit.

MCU Version

The version of MCU firmware.

Camera Firmware

The version of camera firmware.

AF Firmware

The version of firmware which controls Auto-Focus.

Download Log

Click this button to download the information in the **System Information** group, to an Excel file.

Firmware Page



The screenshot shows the ATLONA web interface for the AT-HDVS-CAM-HDMI device. The interface includes a navigation menu on the left with sections for Home, Device Settings, Visual Settings, and Camera. The main content area displays the Firmware Status and Firmware Update sections.

Firmware Status

System	
MCU	V2.1.0
Camera	V2.5.8
Auto Focus	V4.0.2

Check for the most recent firmware update!

Firmware Update

Update File: [Browse](#) [Upgrade](#)

Firmware Status - System

MCU

The version of MCU firmware.

Camera

The version of camera firmware.

Auto Focus

The version of firmware which controls Auto-Focus.

Firmware Update

Update File

Displays the file currently selected for the update process.

Browse

Click this button to select the desired firmware file for the update process.

Upgrade

Click this button to begin the firmware update process.

System Page



The screenshot shows the ATLONA configuration interface for the AT-HDVS-CAM-HDMI device. The left sidebar contains navigation menus for Home, Device Settings, Visual Settings, and Camera. The main content area is titled 'Time Synchronization' and includes the following fields and controls:

- Information:** Device Name (AT-HDVS-CAM-HDMI), Device ID (1). Buttons: Save, Cancel.
- Time:** Date Format (YYYYMM-DD), Date Separator (/), Zone ((GMT-08:00)PST(America & Ca)), Hour Type (24 Hours), NTP Enable (checkbox), Update Interval (1 day), Host URL (time.nist.gov), Host Port (123). Buttons: Save, Cancel.
- Time Synchronization:** Computer Time (2021-01-13 17:00:46). Button: Synchronize.

Information

Device Name

Displays the model of the unit.

Device ID

The device ID.

Save

Click this button to commit changes under this section.

Cancel

Click this button to abort changes under this section.

Time

Date Format

Displays the file currently selected for the update process.

Data Separator

Click this drop-down list to specify the separator between month, day, and year.

Zone

Click this drop-down list to select the desired time zone.

Hour Type

Click this drop-down list to switch the time format between 12-hour and 24-hour clocks.

NTP

Click this check box to enable the use of an external NTP server.

Configuration and Management Interfaces

Update Interval

Click this drop-down list to select the time interval (in days), which the camera will poll the NTP server. This field is only active if the **NTP** check box is marked with a checkmark.

Host URL

Specify the NTP server address in this field. This field is only active if the **NTP** check box is marked with a checkmark.

Host Port

Specify the NTP port in this field. This field is only active if the **NTP** check box is marked with a checkmark.

Save

Click this button to commit changes under this section.

Cancel

Click this button to abort changes under this section.

Time Synchronization

Computer Time

Displays the current time on the computer.

Synchronize

Click this button to synchronize the computer time.

Network Page

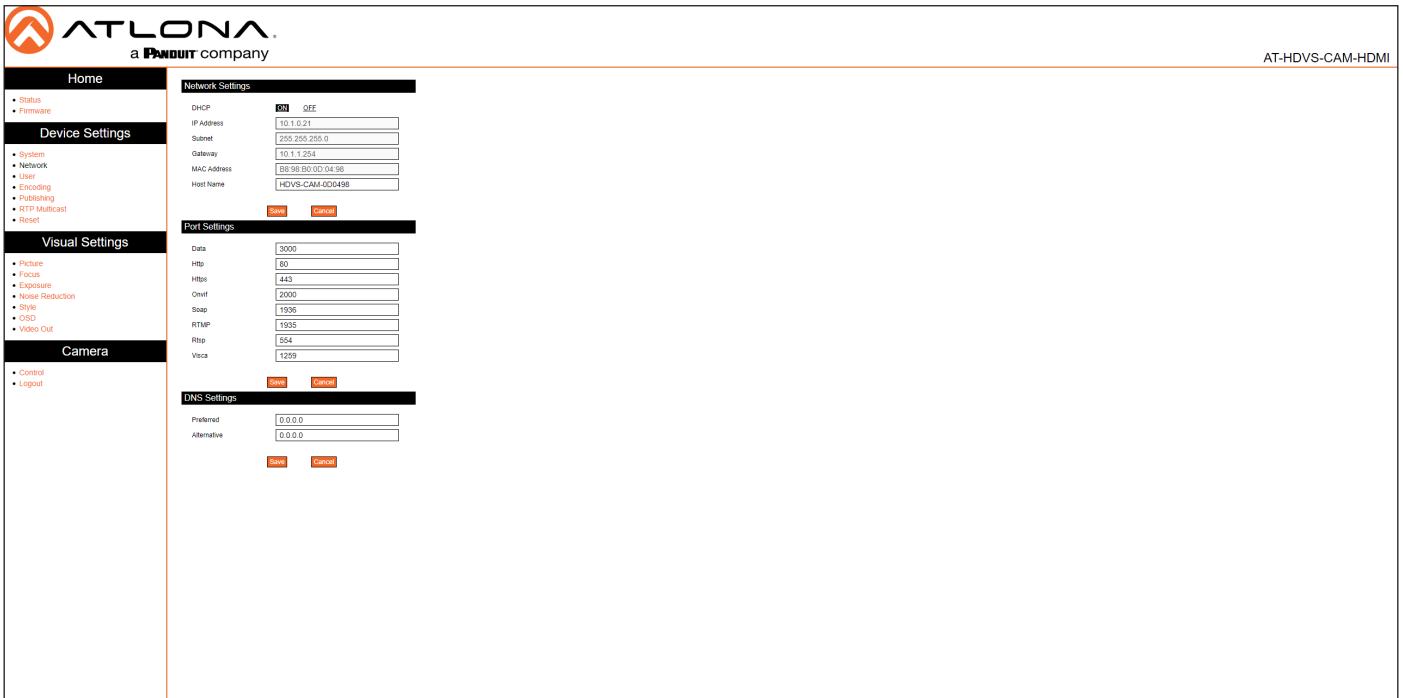

Network Settings

DHCP

Switch between DHCP (ON) and static (OFF).

IP Address

Specify the IP address of the AT-HDVS-CAM-HDMI in this field. This field is only active if **DHCP** is set to **OFF**.

Subnet

Specify the IP subnet mask in this field. This field is only active if **DHCP** is set to **OFF**.

Gateway

Specify the default gateway (router) address in this field. This field is only active if **DHCP** is set to **OFF**.

MAC Address

Displays the MAC address of the AT-HDVS-CAM-HDMI.

Host Name

Specify the host name of the AT-HDVS-CAM-HDMI in this field. The default host name will be HDVS-CAM-[last six digits of MAC address].

Save

Click this button to commit changes under this section.

Cancel

Click this button to abort changes under this section.

Configuration and Management Interfaces

Port Settings

Enter the required port number in each of these fields. Each field contains the default port settings. Available values are from 0 to 65535.

Save

Click this button to commit changes under this section.

Cancel

Click this button to abort changes under this section.

DNS Settings

Preferred

Enter the primary DNS server address in this field.

Alternative

Enter the failover DNS server address in this field.

User Page



ATLONA
a PANOUT company

AT-HDVS-CAM-HDMI

Home

- Status
- Firmware

Device Settings

- System
- Network
- User
- Encoding
- Publishing
- RTP Multicast
- Reset

Visual Settings

- Picture
- Focus
- Exposure
- Noise Reduction
- Style
- OSD
- Video Out

Camera

- Control
- Logout

User

Change password

User Name	admin
New password	
Re-enter password	

Save Cancel

User

User Name

Enter the desired user name in this field.

New password

Enter the new password in this field.

Re-enter password

Confirm the new password by entering it in this field.

Save

Click this button to commit changes under this section.

Cancel

Click this button to abort changes under this section.

Encoding Page



The screenshot shows the ATLONA web interface for the AT-HDVS-CAM-HDMI device. The 'Video Encoding' section is active, displaying the following settings:

- RTSP Server:** Enabled (Default)
- RTMP Server:** Enabled (Default)
- Main Stream:**
 - Compressed Format: H.264
 - Profile: HP
 - Image Size: 1920*1080
 - Bit Rate(Kb/s): 4096
 - Stream Key: Webv0
- Sub Stream:**
 - Compressed Format: H.264
 - Profile: HP
 - Image Size: 320*180
 - Bit Rate(Kb/s): 512
 - Stream Key: Webv1

Buttons for 'Save', 'Cancel', and 'Default' are visible at the bottom of the configuration area.

Video Encoding

RTSP Server

Enable / disable the RTSP protocol.

RTMP Server

Enable / disable the RTMP protocol.

Main Stream / Sub Stream

These settings affect the main stream, which is the primary video feed and provides the highest quality video. This stream is used by a digital recorder when saving footage to hard disk. Adjusting these settings will affect the recording size and available recording time on the hard disk.

Sub Stream is the secondary video feed and provides a lower quality video stream. This stream is used to stream video to computers and mobile devices. Adjusting these settings will affect the bandwidth of the stream.

Compressed Format

Click this drop-down list to select the desired video codec.

Format	Description
H.264 (AVC)	Advanced Video Codec - Industry-standard codec that provides good-quality compressed video output.
H.265 (HVEC)	High-Efficiency Video Coding - Provides a higher compression ratio than H.264, thus reducing the bandwidth necessary for high-resolution (2K/4K) video capture.

Configuration and Management Interfaces

Compressed Format

Click this drop-down list to select the desired profile.

Profile	Description
BP	Baseline Profile - Supports a limited set of processes and is designed to meet the needs of mobile devices.
MP	Main Profile - Supports a good number of processes and is typically used for devices such as set-top boxes.
HP	High Profile - Supports all processes of H.264 and targets FullHD (1080p) applications such as Blu-ray and satellite streams.

Image Size

Click this drop-down list to select the desired resolution. These resolutions are available for all codecs and profiles.

Resolution		
1920x1080	1280x720	640x480

Bit Rate (kb/s)

Enter the desired bit rate in this field.

Encoding Protocol	Bit Rate Range
H.264	64 ... 20480 kb/s
H.265	64 ... 40960 kb/s

Stream Key

Enter the stream key in this field. This key (code) is used to identify the stream, allowing the stream to be displayed on a web site.

Save

Click this button to commit changes.

Cancel

Click this button to abort changes.

Default

Click this button to restore default settings.

Configuration and Management Interfaces

Publishing Page



Main Stream / Sub Stream

These settings affect the main stream, which is the primary video feed and provides the highest quality video.

Sub Stream is the secondary video feed and provides a lower quality video stream. This stream is used to stream video to computers and mobile devices.

Enable

Click this check box to enable the main stream / sub stream. When a stream is enabled, the check box will be checked.

Protocol Type

This drop-down list is set to RTMP and cannot be changed.

Host Address

Specify the IP address or stream URL in this field.

Host Port

Specify the port in this field.

Stream Key

Specify the stream key in this field.

Save

Click this button to commit changes.

Cancel

Click this button to abort changes.

RTP Multicast Page



Main Stream / Sub Stream

These settings affect the main stream, which is the primary video feed and provides the highest quality video.

Sub Stream is the secondary video feed and provides a lower quality video stream. This stream is used to stream video to computers and mobile devices.

Enable

Click this check box to enable the main stream / sub stream. When a stream is enabled, the check box will be checked.

Protocol Type

Click this drop-down list to set the protocol.

Protocol	Description
RTP	Real Time Protocol
TS	Transport Stream (MPEG-TS)

Multicast Address

Specify the multicast IP address of the stream in this field.

Multicast Port

Specify the port in this field.

Access Method

Displays the fully-qualified URL of the stream, based on the above settings.

Save

Click this button to commit changes.

Cancel

Click this button to abort changes.

Reset Page



The screenshot displays the ATLONA configuration interface for the AT-HDVS-CAM-HDMI device. The interface features a left-hand navigation menu with sections for Home, Device Settings, Visual Settings, and Camera. The main content area is titled "Factory Reset" and contains two buttons: "Factory Reset" and "Reboot".

Home

- Status
- Firmware

Device Settings

- System
- Network
- Users
- Encoding
- Publishing
- RTP Multicast
- Reset

Visual Settings

- Picture
- Focus
- Exposure
- Noise Reduction
- Style
- OSD
- Video Out

Camera

- Control
- Logout

Factory Reset

Reset to Factory Default Settings? **Factory Reset**

Reboot

Reboot/Recycle power(device will maintain current settings)? **Reboot**

Factory Reset

Factory Reset

Click this button to factory-reset the AT-HDVS-CAM-HDMI.

Reboot

Reboot

Click this button to reboot/power-cycle the AT-HDVS-CAM-HDMI.

Configuration and Management Interfaces

Picture Page

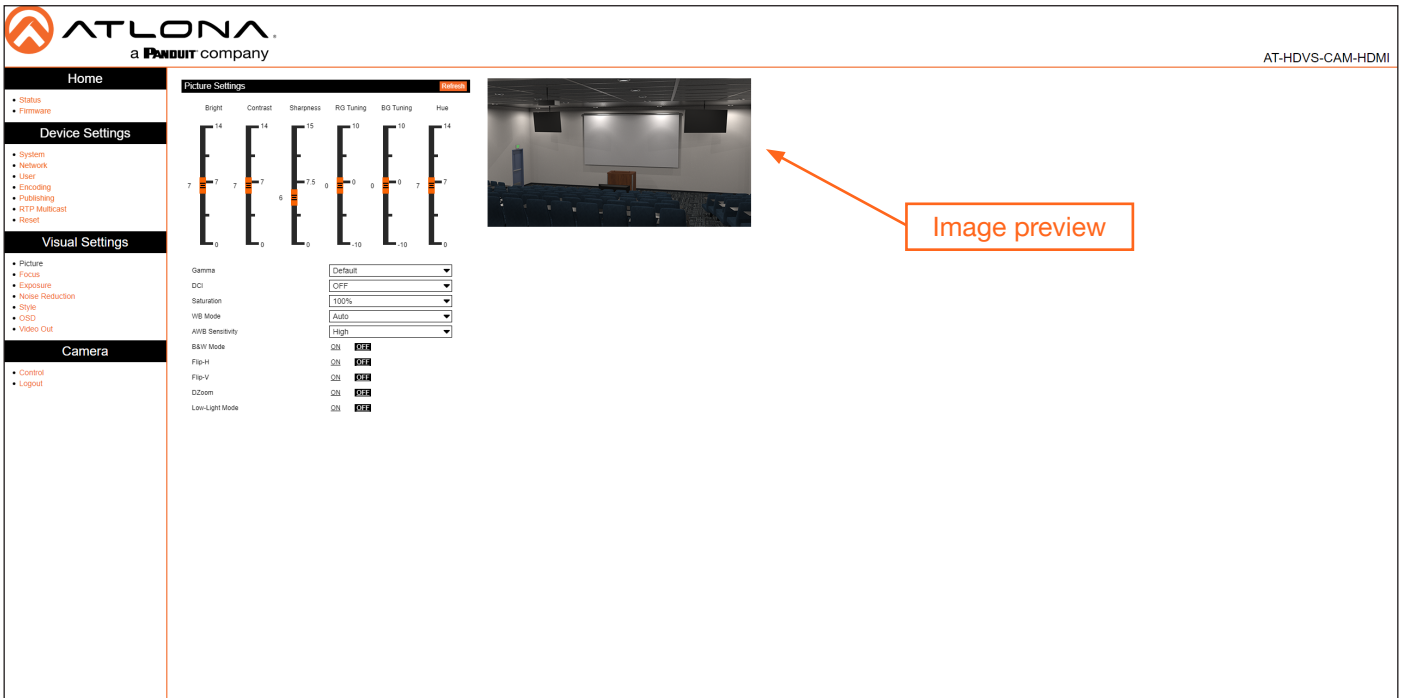

Picture Settings

Bright

Click and drag this slider to adjust the picture brightness between a value of 0 and 14. Larger values produce a brighter image. The default setting is 6.

Contrast

Click and drag this slider to adjust the picture contrast between a value of 0 and 14. Larger values produce a higher contrast image. The default setting is 7.

Sharpness

Click and drag this slider to adjust the picture sharpness between a value of 0 and 14. Larger values will produce a sharper image. The default setting is 7.5.

RG Tuning

Click and drag this slider to adjust the red-gain tuning between a value of -10 and 10. Use this feature to reduce unwanted red colors. Larger values will introduce a red tint to the image. The default setting is 0.

BG Tuning

Click and drag this slider to adjust the blue-gain tuning between a value of -10 and 10. Use this feature to reduce unwanted blue colors. Larger values will introduce a blue tint to the image. The default setting is 0.

Hue

Click and drag this slider to adjust the picture hue between a value of 0 and 14. Larger values will introduce more red into the image, while smaller values will introduce more blue into the image. The default setting is 7.

Gamma

Click this drop-down list to select the desired gamma setting. Larger values will display a darker image. The default setting is Default.

DCI

Click and drag this slider to adjust the dynamic contrast of the image. Larger values produce a higher contrast image. The default setting is OFF.

Configuration and Management Interfaces

Saturation

Click this drop-down list to select the desired saturation value. Available values are between 60% and 200% in increments of 10. Larger values will produce an image with a higher color contrast. The default setting is 100%.

WB Mode

Click this drop-down list to select the desired white balance setting.

WB Mode	Description
Auto	Automatically adjusts white balance based on the captured image. This is the default setting.
Manual	Permits manual white balance setting using the RG (Red Gain), BG (Blue Gain), and Hue slider settings.
OnePush	When selected, this option will display an Adjust button. Click the Adjust button to allow the camera to make automatic white balance adjustment of the captured image. This setting is different than Auto , in that the Auto setting will constantly adjust the image, based on the lighting. The OnePush option, allows the white balance to be set, based on the current lighting, much like setting the white balance on a DSLR camera.
VAR	When selected, a Color Temp drop-down list will be displayed below the WB Mode drop-down list. Color temperature (in Kelvin) can be selected from the Color Temp drop-down list. The Color Temp drop-down list provides values from 2400K to 7100K, in increments of 100K. The Hue slider can also be used to provide granular tuning of the color temperature.

AWB Sensitivity

Click this drop-down list to select the auto-white balance sensitivity. AWB automatically color-corrects the captured image, by analyzing the light reaching the camera sensor, and attempts to correct for any color shifts that may otherwise take place.

B&W Mode

Setting this value to **ON** will remove color information from the image.

Flip-H

When set to **ON**, the image will be horizontally flipped.

Flip-V

When set to **ON**, the image will be vertically flipped.

DZoom

When set to **ON**, dynamic zoom will be enabled.

Low-Light Mode

When set to **ON**, low-light mode is enabled. This provides better image quality in low-light environments.

Configuration and Management Interfaces

Focus Page

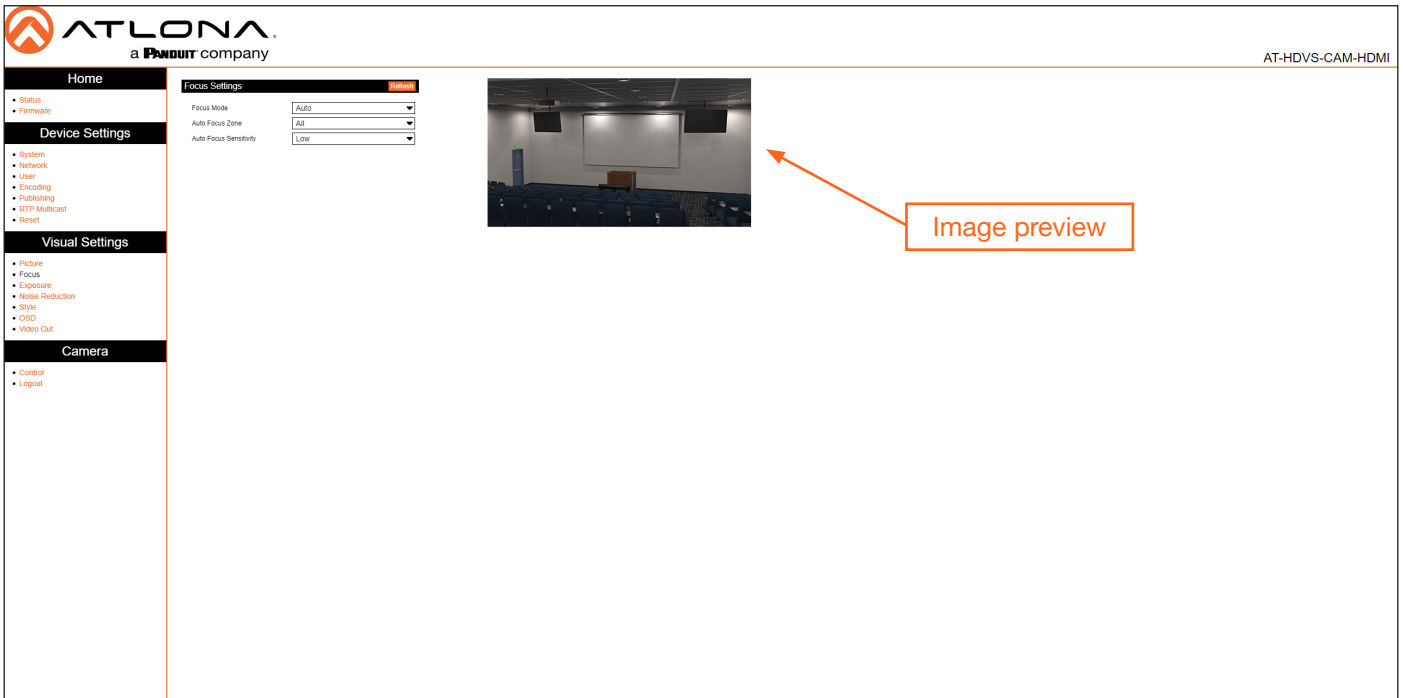

Focus Settings

Focus Mode

Click this drop-down list to select the desired focus mode.

Focus Mode	Description
Auto	Automatically adjusts focus based on the captured image.
Manual	Permits manual focus control.
OnePush	When selected, this option will adjust the focus based on the currently captured image. The same focus setting will be applied to all other camera movement.

Auto Focus Zone

Click this drop-down list to select the zone where auto focus will be applied. Available options are Top, Center, Bottom, and All. The default setting is All.

Auto Focus Sensitivity

Click this drop-down list to select the auto focus sensitivity. Available options are Low, Med, and High. The default setting is Low.

Configuration and Management Interfaces

Exposure Page

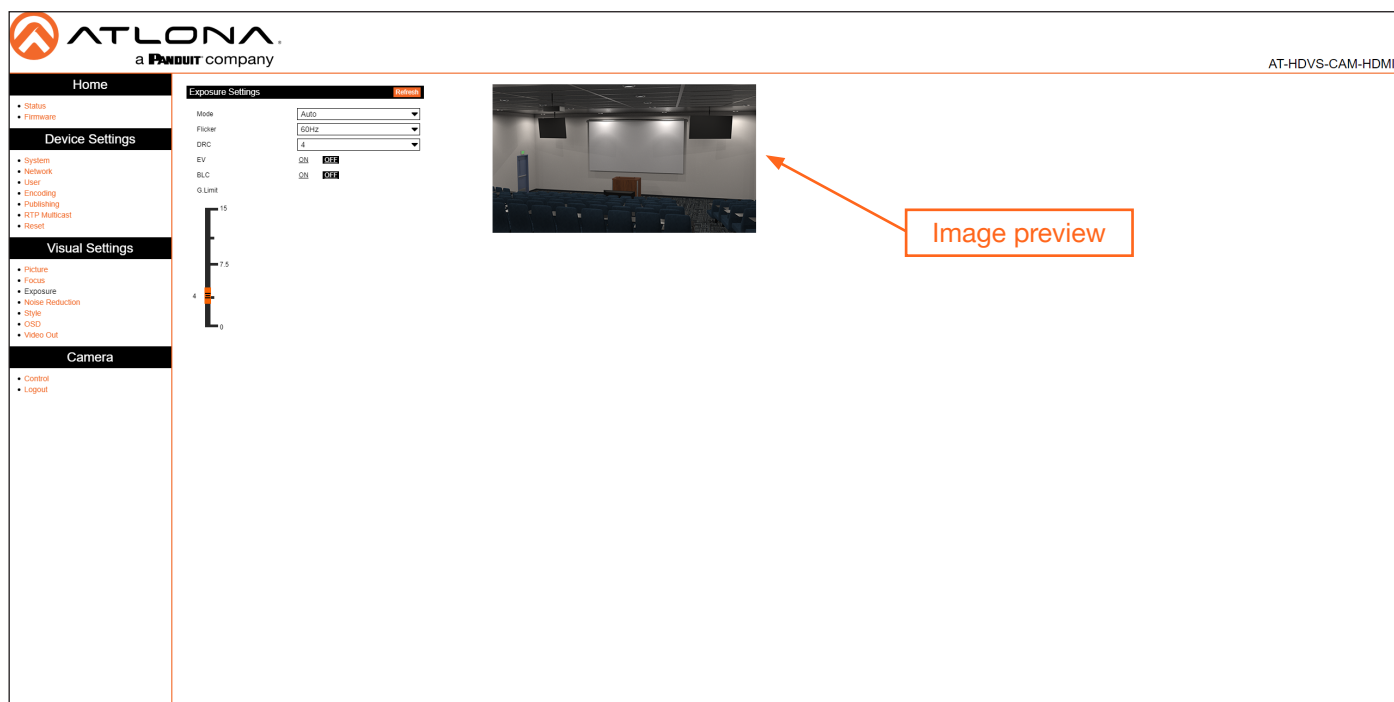

Exposure Settings

Mode

Click this drop-down list to select the desired mode.

Mode	Description
Auto	Automatically adjusts the exposure, based on available light.
Manual	<p>Permits manual exposure control. When selected, the following options will be available: Iris, Shutter, and Gain. These options are similar to aperture, shutter speed, and ISO speed in a DSLR camera.</p> <p>Iris: Click this drop-down list to select the f-stop value. The larger the value, the smaller the diameter of the iris (aperture). Larger values permit less light into the camera sensor, making the image darker.</p> <p>Shutter: Click this drop-down list to select the shutter speed. This is the time interval required to open and close the shutter during each frame of video. Larger values (fast shutter speeds) will allow less light to enter the camera sensor, producing darker images, but will produce crisp video. Low values (slow shutter speeds) will allow more light to enter the camera sensor, allowing for brighter images, but will make moving objects appear blurry.</p> <p>Gain: Click and drag this slider to adjust the gain. Gain is similar to adjusting the ISO (image noise) values on a DSLR. Larger values will increase the brightness of the image in low-light environments, but will introduce noise (grain) into the image. Smaller values decrease the image brightness in bright/outside environments and introduce less noise into the image.</p>
SAE	Shutter Automatic Exposure (SAE). When selected, this option will measure the incoming light and automatically adjust the iris (aperture) based on the selected shutter speed.

Configuration and Management Interfaces

Mode	Description
AAE	Aperture Automatic Exposure (AAE). When selected, this option will measure the incoming light and automatically adjust the shutter speed based on the selected iris (aperture) setting.
Bright	When selected, a Bright slider will be displayed. The larger the value, the brighter the image.

Flicker

Click this drop-down list to set the flicker setting. Available values are 50 Hz, 60 Hz, and OFF. The default setting is OFF. Note that this option is not available when Mode is set to Manual.

DRC

Dynamic Range Control. DRC is the measurement between maximum and minimum values in an image. Larger values attempt to discern between different color values in the image.

EV

Exposure Value. This option essentially combines both shutter speed and iris (aperture) into a single value. However, unlike independently adjusting shutter speed and iris settings, this value restricts the effect to the image exposure. When this option is set to ON, then an EV Level slider bar will be displayed.

BLC

Back Light Compensation. BLC is a feature which automatically adjusts the exposure control of the camera. When enabled, BLC will attempt to increase the ambient foreground light and “darken” any background light. For example, a subject standing in front of a window in the daytime, will produce a silhouetted effect. Enabling BLC will compensate for the difference in lighting by enhancing the foreground lighting on the subject.

Configuration and Management Interfaces

Style Page

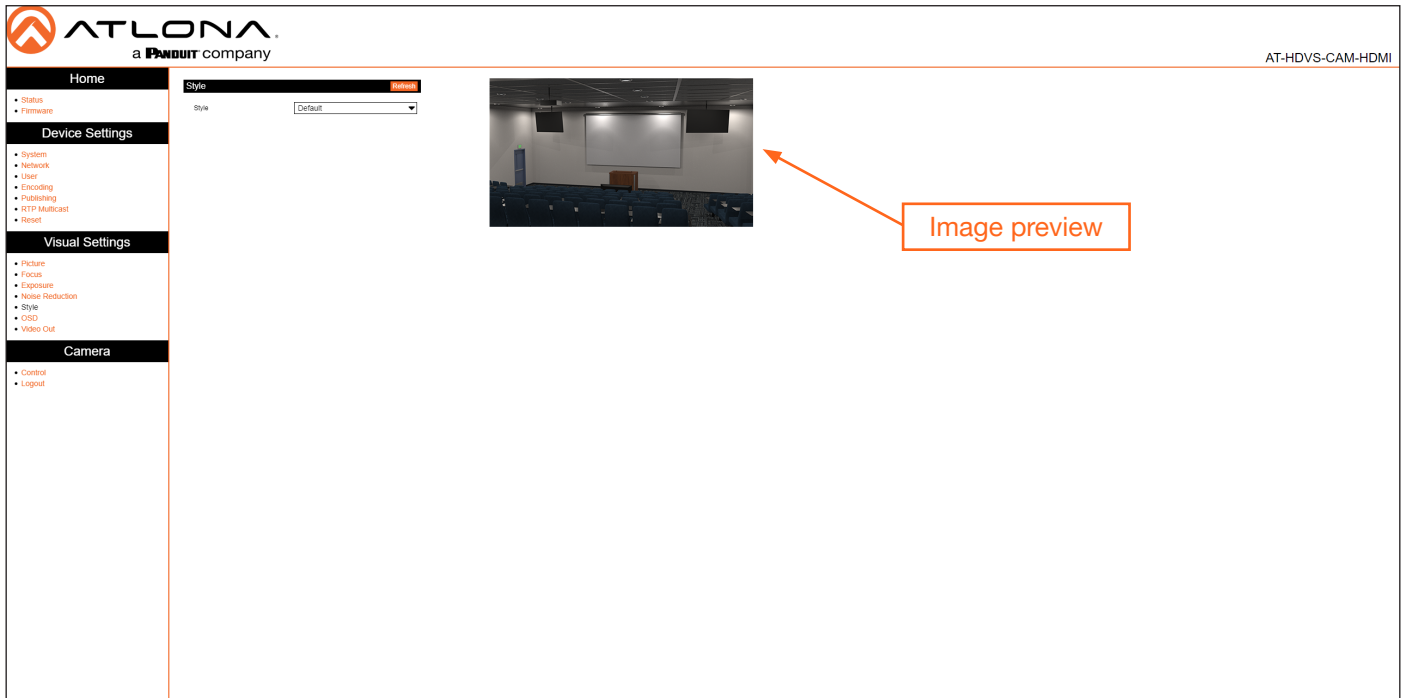

Style

Style

Click this drop-down list to select the desired image style. Style is an image preset, which produces a desired look. Available options are: Default, Normal, Clarify, Bright, and Soft.

Configuration and Management Interfaces

OSD Page

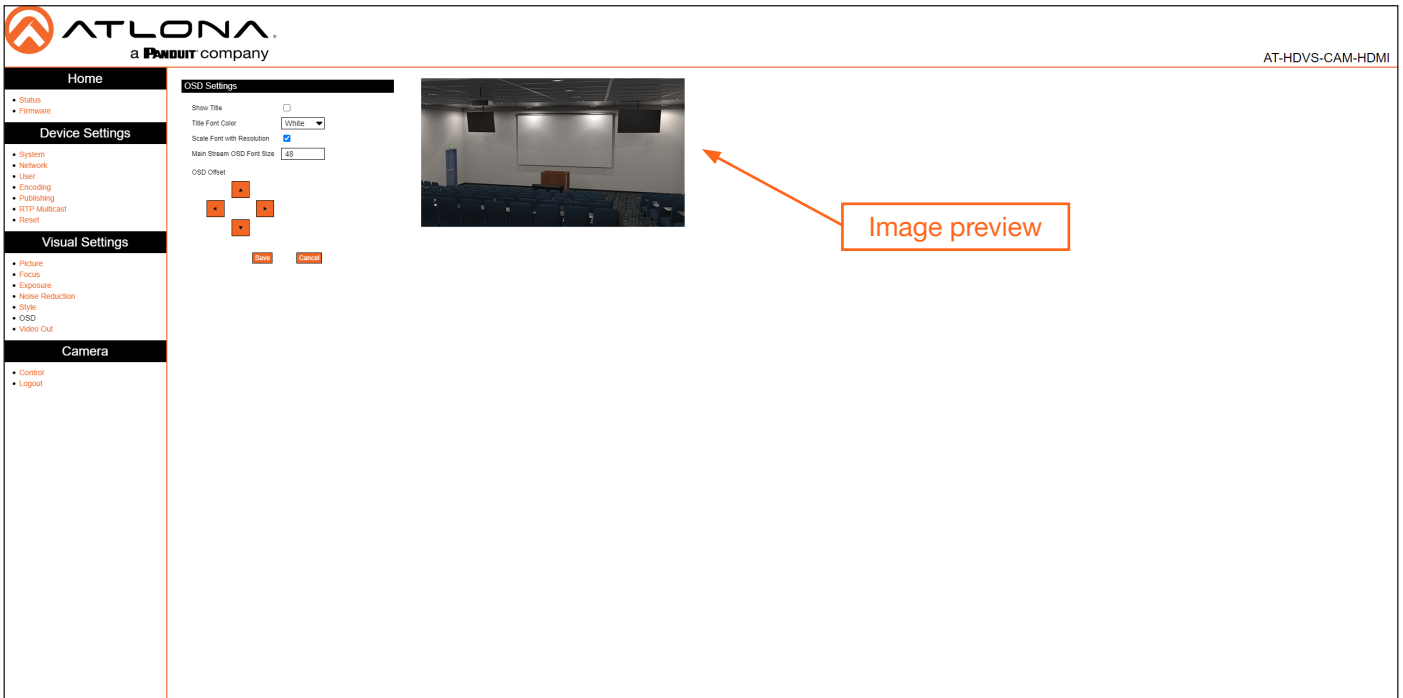

OSD Settings

Show Title

Click this check box to display the device name in the upper-left corner (default position) of the screen. When enabled, the check box will display a check mark. To change the device name, refer to the System > Information > Device Name on the [System Page \(page 31\)](#). Click the **Save** button to have changes take effect.

Title Font Color

Click this drop-down list to set the font color of the title. Available options are White, Black, Yellow, Red, and Blue.

Scale Font with Resolution

Click this check box to scale the font title when the resolution changes. When enabled, the check box will display a check mark.

Main Stream OSD Font Size

Specify the title font size in this field. When enabled, the check box will display a check mark. Click the **Save** button to have changes take effect.

OSD Offset

Click these arrows to position the title font on the screen. Click the **Save** button to have changes take effect.

Save

Click this button to commit changes.

Cancel

Click this button to abort changes.

Configuration and Management Interfaces

Video Out Page

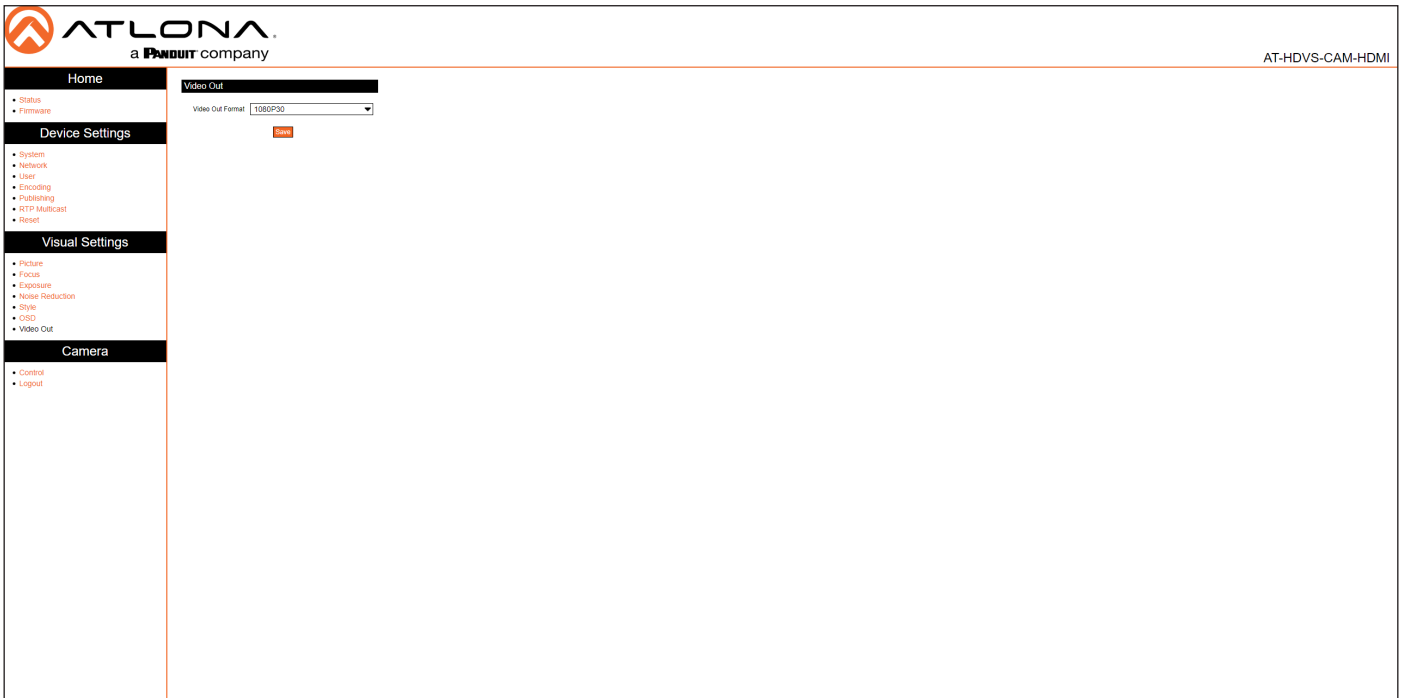

The screenshot shows the ATLONA configuration interface for the AT-HDVS-CAM-HDMI device. The left sidebar contains navigation menus: Home, Device Settings (with sub-items: Status, Firmware, System, Network, Users, Encoding, Publishing, RTP Multicast, Reset), Visual Settings (with sub-items: Picture, Focus, Exposure, Noise Reduction, Style, OSD), and Camera (with sub-items: Control, Logout). The main content area is titled 'Video Out' and features a dropdown menu for 'Video Out Format' currently set to '1080P30', and a red 'Save' button below it.

Video Out

Video Out Format

Click this drop-down list to select the desired output resolution. Available resolutions are listed in the table below.

Format	
1080P60	720P60
1080P50	720P50
1080P30	1080P59.94
1080P25	1080I59.94
1080I60	1080P29.97
1080I50	720P59.94

Save

Click this button to commit changes.

Control Page

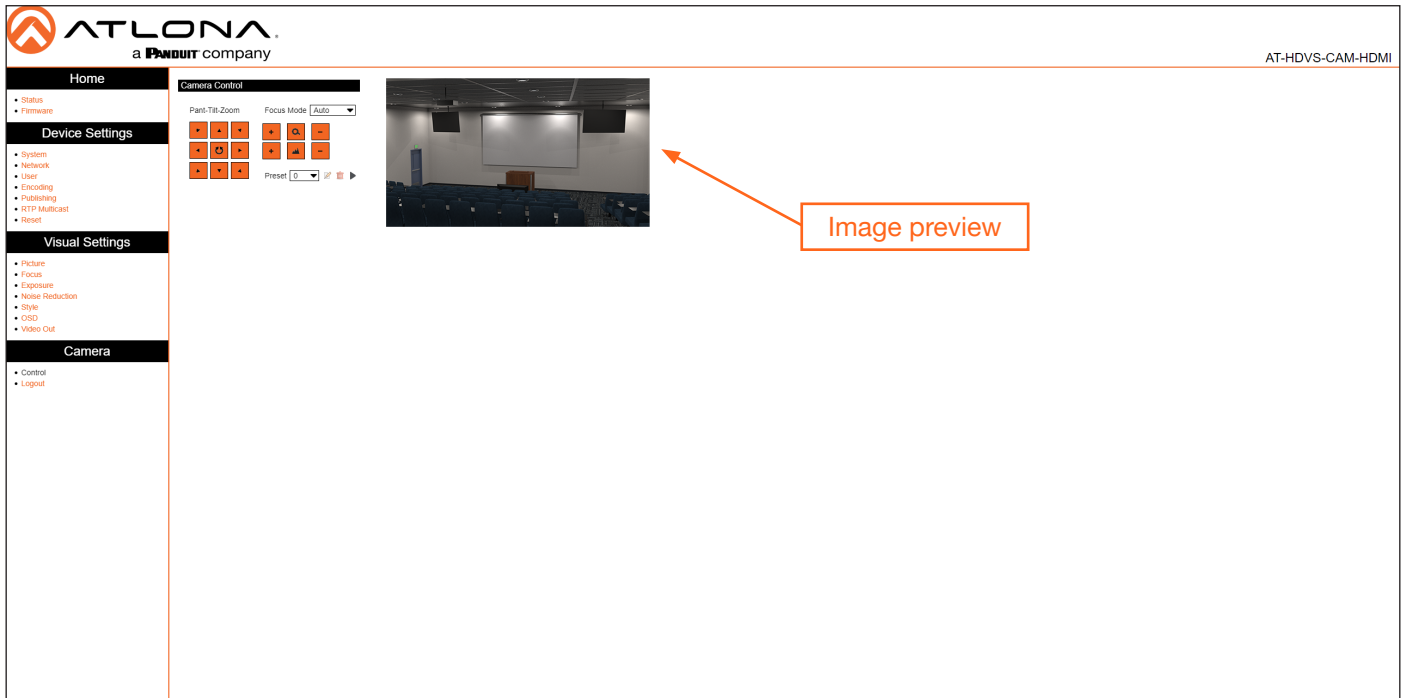

Camera Control

Refer to [Controlling the Camera \(page 16\)](#) for more information.

Pan-Tilt-Zoom

Click these arrows to adjust the pan, tilt, and zoom of the camera.

Focus Mode

Click this drop-down list to select the desired focus mode.

IR Remote and OSD

IR Remote Control

The AT-HDVS-CAM-HDMI comes with an IR remote control for full control of the camera and use of the OSD menu.



Power

Toggle the camera on and off with the power button. Press and hold for 3 seconds to place the camera into standby mode.

Number buttons

Used in the selection or creation of camera presets.

Focus

Adjust the focus of the camera using the + and - buttons.

Auto

Switch the camera focus mode to auto.

Manual

Switch the camera focus mode to manual.

Zoom

Zoom in (+) or out (-) using these buttons.

Set Preset

Set the camera into position then press the Set Preset button followed by a number key (0-9) to set that position to a preset.

Clear Preset

Press clear preset followed by a number key to erase the preset set to that number.

Arrow buttons

Use the arrow buttons to adjust the camera position or navigate within the OSD menu.

Home buttons

Returns the camera to the middle position.

BLC ON/OFF

Toggles backlight compensation on or off.

Menu

Use to pull up the OSD menu.

OSD

The OSD will display after pressing the MENU button.

OSD					
Language	English Chinese				
Setup	Protocol	Auto	Visca	PELCO-D	PELCO-P (Options)
	Visca Address	1	1		
	Visca Address	Off	Off		
	PELCO-P Address	1			1
	PELCO-D Address	1		1	
	Baudrate	9600	9600	9600	9600

IR Remote and OSD

OSD Cont.								
Camera	Exposure	Mode	Auto	Bright	AAE	SAE	Manual	
		Bright		7				0 to 23
		IRIS			F1.8		F1.8	F1.8, F2.0, F2.4, F2.8, F3.4, F4.0, F4.8, F5.6, F6.8, F8.0, F9.6, F11, Close
		Shutter				1/100	1/100	1/25, 1/30, 1/50, 1/60, 1/90, 1/100, 1/120, 1/180, 1/250, 1/325, 1/500, 1/1000, 1/2000, 1/3000, 1/4000, 1/6000, 1/10000
		EV	ON					ON, OFF
		EV Level	0					-7 to 7
		BLC	OFF					ON, OFF
		Flicker	50Hz	50Hz	50Hz			OFF, 50Hz, 60Hz
		G. Limit	4	4	4			0 to 15
		DRC	4	4	4	4		Close, 1 to 8
	Color	WB Mode	Auto	Onepush	Manual	7000K	6500K	5500K, 5000K, 4500K, 4000K, 3500K, 3000K
		RG Tuning	0		RG145			-10 to 10
		BG Tuning	0		BG56			-10 to 10
		Saturation	100%	100%	100%	100%	100%	60, 100, 110, 120, 200
		Hue	7	7	7	7	7	0 to 14
		AWB Sens	High					High, Middle, Low
	Image	Brightness	6		0 to 14			
		Contrast	8		0 to 14			
		Sharpness	6		0 to 15			
		Flip-H	OFF		OFF, ON			
		Flip-V	OFF		OFF, ON			
		B&W Mode	Color		Color, B&W			
		Gamma	0.45		Default, 0.45, 0.50, 0.55, 0.63			
		DCI	2		Close, 1 to 8			
		Image Quality	0		0 to 5			
	Focus	Focus Mode	Auto		Auto, Onepush, Manual			
		AF-Zone	Center		Center, Top, All, Bottom			
		AF-Sensitivity	Low		Low, High, Middle			
	Noise Reduction	NR-2D	2		OFF, Auto, 1 to 7			
		NR-3D	4		OFF, 1 to 8			
		Dynamic Hot Pixel	OFF		OFF, 1 to 5			
	Style	Clarity	Clarity, Normal, Default, Soft, Bright					

OSD Cont.			
P/T/Z	Speed By Zoom Zoom Speed Acc Curve	ON 8 Slow	ON, OFF 1 to 8 Slow, Fast
Version	MCU Version Camera Version AF Version	X.X.X X.X.X X.X.X	20YY-MM-DD 20YY-MM-DD 20YY-MM-DD
Ethernet	IP Address Subnet Mask Gateway	XXX.XXX.XXX.XXX XXX.XXX.XXX.XXX XXX.XXX.XXX.XXX	e.g. 10.20.20.233 e.g. 255.255.255.0 e.g. 10.20.20.1
Restore Default	Restore Default?	NO, YES - Restore Default Now...	

Remote Functions

The included IR Remote Control provides a set of functions which can be used to change the behavior of the AT-HDVS-CAM-HDMI. Each function is invoked by sequentially pressing the following series of keys on the keypad.

Function	Keystrokes
Clear all presets	[#] + [#] + [#]
Flip video horizontally and vertically	[*] + [#] + [9]
Reset username, password, and IP address	[*] + [#] + [MANUAL]
Switch video format to 1080p60	[#] + [#] + [0]
Switch video format to 1080p50	[#] + [#] + [1]
Switch video format to 1080i60	[#] + [#] + [2]
Switch video format to 1080i50	[#] + [#] + [3]
Switch video format to 720p60	[#] + [#] + [4]
Switch video format to 720p50	[#] + [#] + [5]
Switch video format to 1080p30	[#] + [#] + [6]
Switch video format to 1080p25	[#] + [#] + [7]
Switch video format to 720p30	[#] + [#] + [8]
Switch video format to 720p25	[#] + [#] + [9]

Appendix

Using VLC Player

This section provides step-by-step instructions on how to display a stream using the VideoLAN VLC media player. Before proceeding, make sure that both the Main Stream and Sub Stream are properly configured. Refer to the User Manual for more information.

1. Launch VLC media player.
2. Click the **Media > Open Network Stream...**

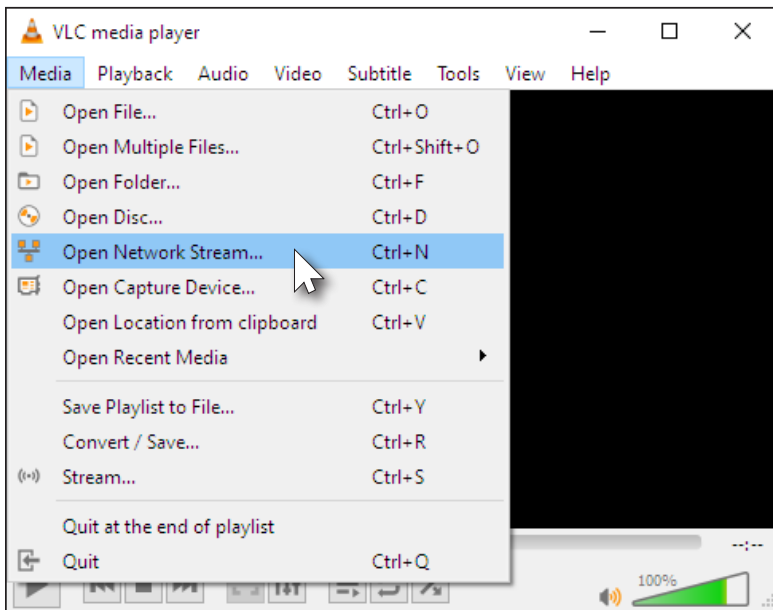

3. Click the **Network** tab.
4. Refer to the **RTP Multicast** page in the AT-HDVS-CAM-HDMI web server, and locate the **Access Method** field. Copy this information into the provided field within the VLC **Network** tab. Note that the **Access Method** fields for the **Main Stream** and **Sub Stream** will differ. Make sure you specify the correct stream to broadcast.

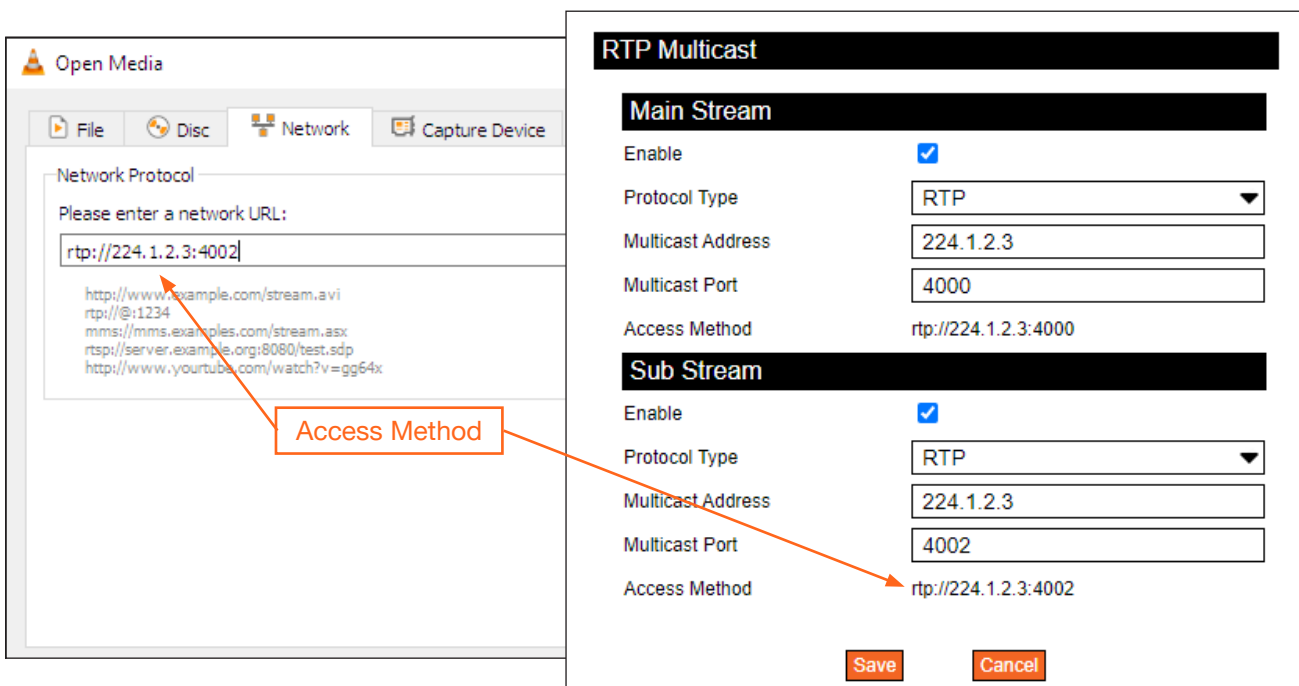

5. Click the **Play** button to begin streaming.

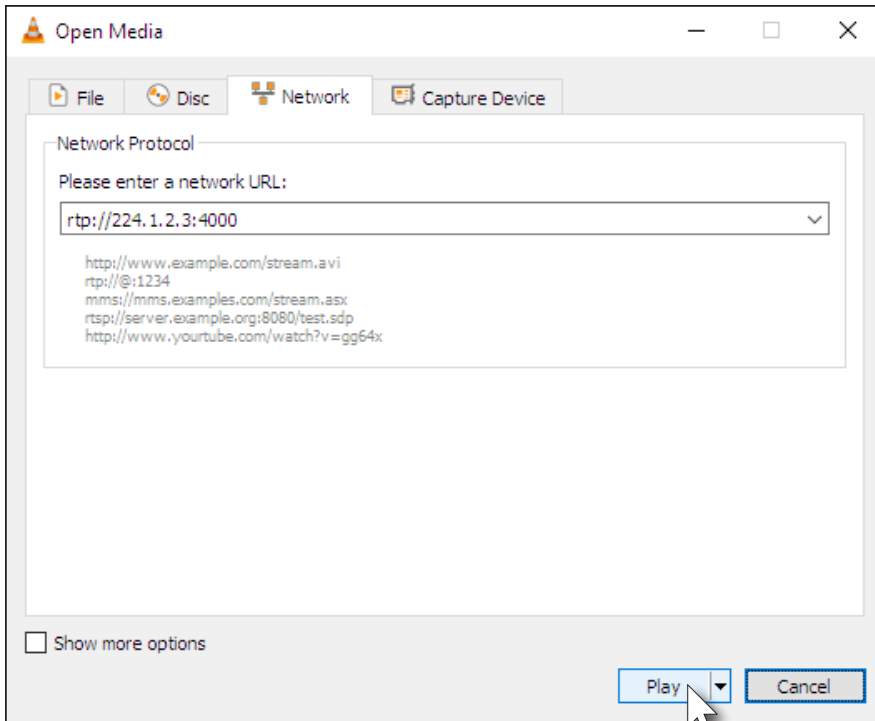

VLC will begin buffering the stream. Note that it may take a few moments for the network stream to be displayed.

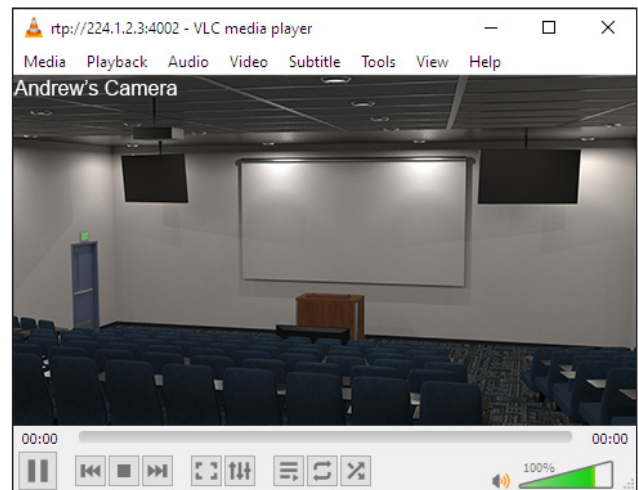
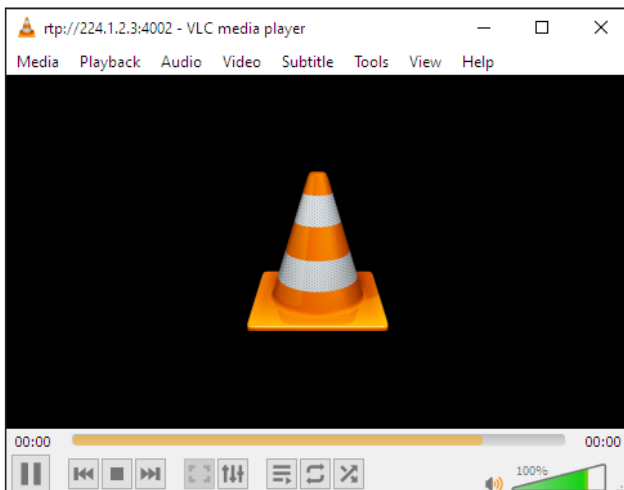

Using Facebook Live

This section provides step-by-step instructions on how to display a stream using Facebook Live. Before proceeding, make sure that both the Main Stream and Sub Stream are properly configured. Refer to the User Manual for more information.

1. Launch a web browser and login to your Facebook account.
2. Click **Live Video** on the news feed page.

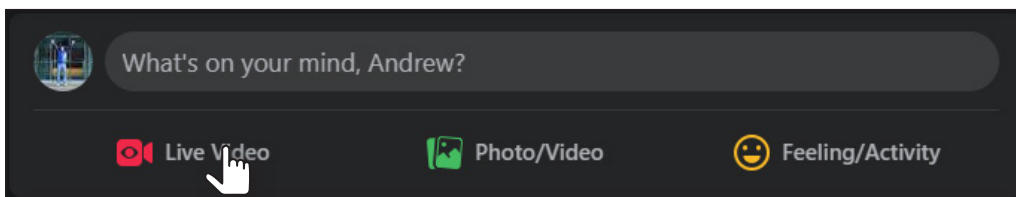

3. Under the **Stream Setup** tab, click **Use Stream Key**.

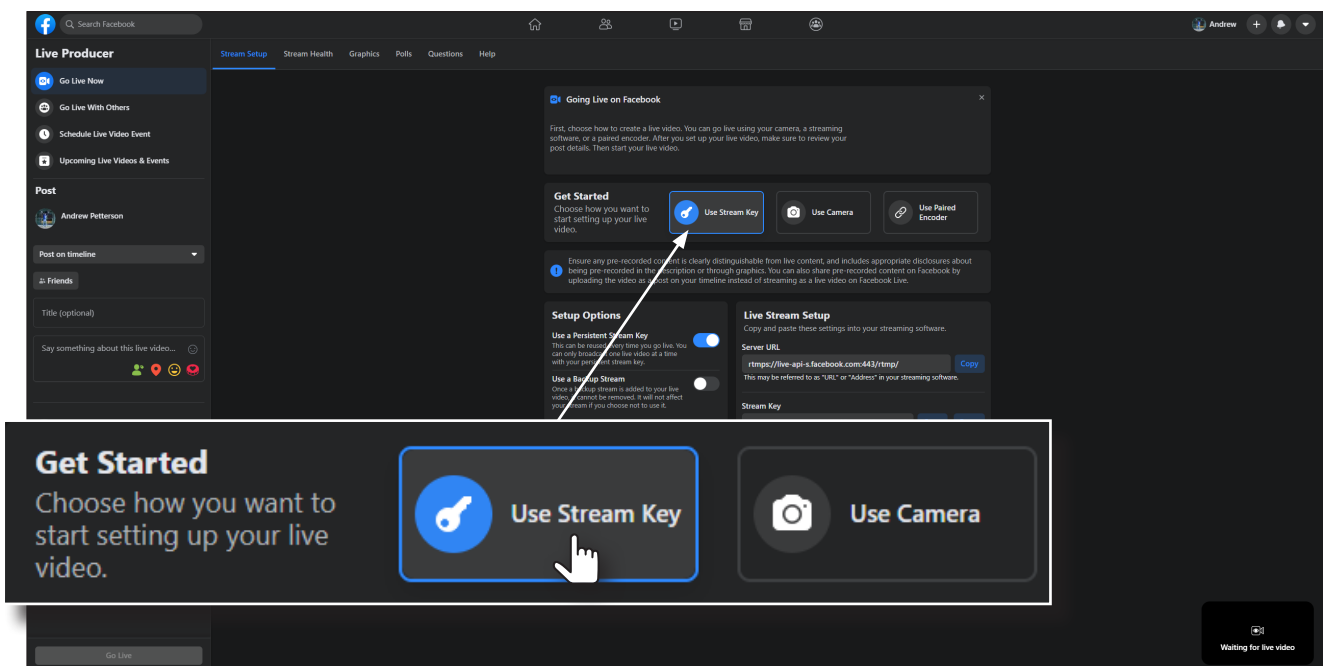

4. Under **Live Stream Setup**, click the **Copy** button, next to **Server URL**.

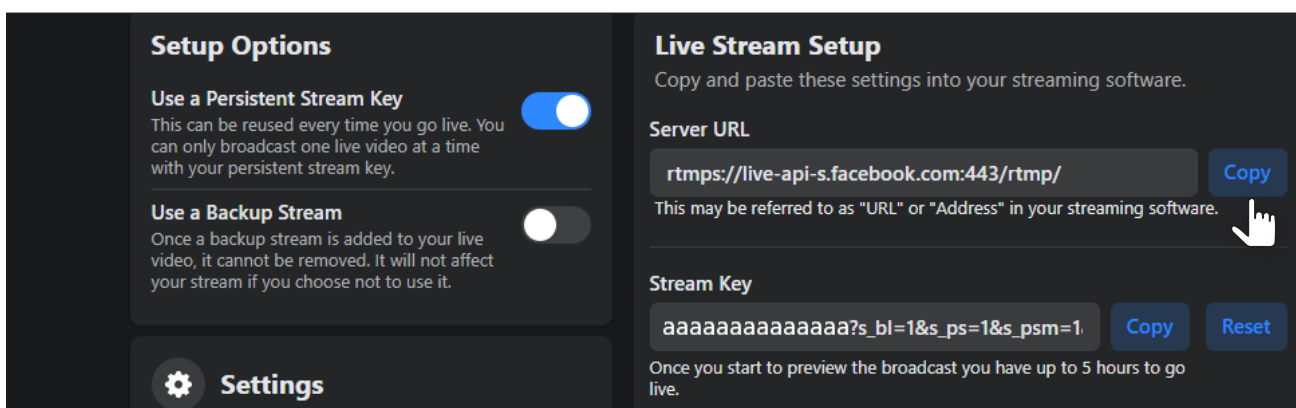

5. Go to the **Publishing** page of the AT-HDVS-CAM-HDMI web server.
6. Paste the contents from the **Server URL** field, on Facebook, to the **Host Address** field in the camera web interface. Note that the contents of the Facebook **Server URL** field can be placed under the **Main Stream** or **Sub Stream**. Make sure that the contents are pasted into the correct field.

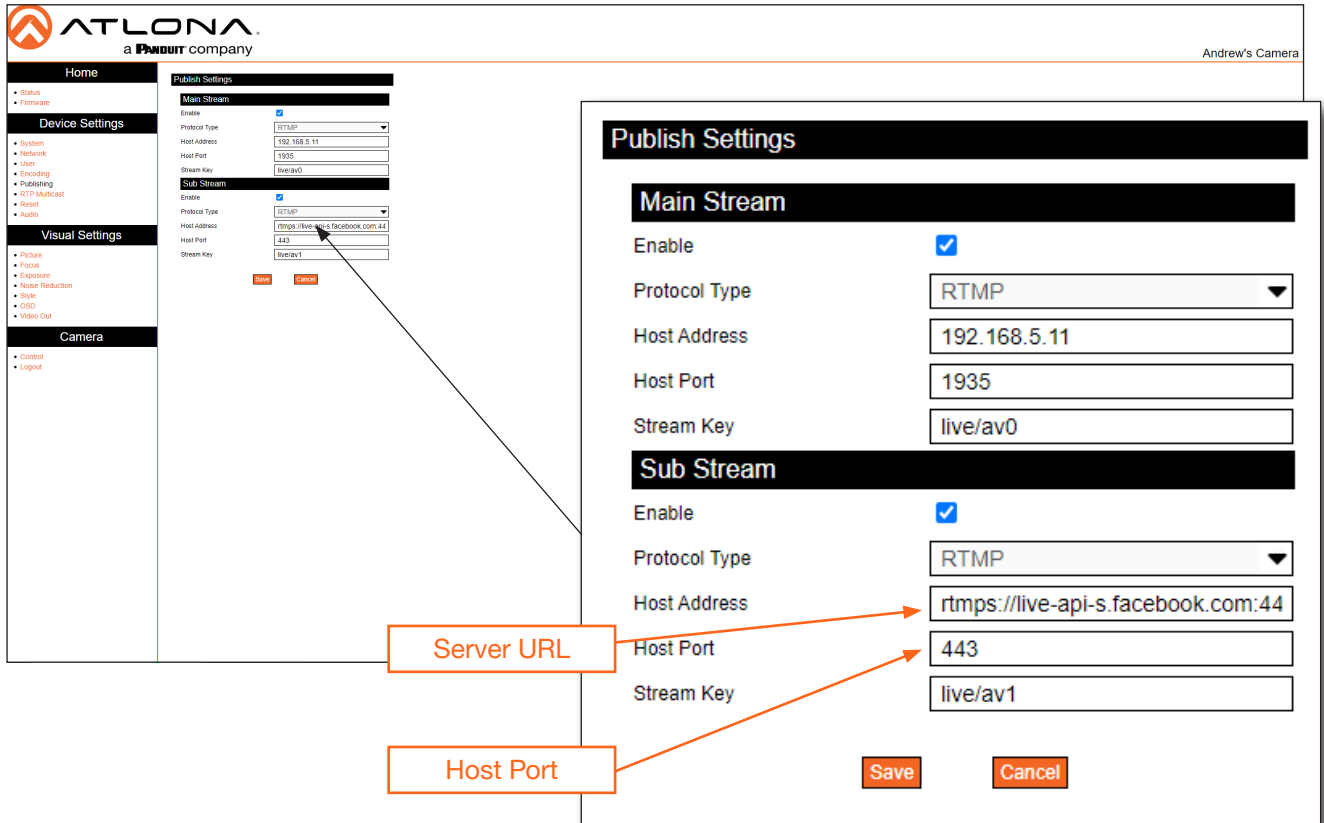

7. Enter 443 in the **Host Port** field, as shown. This step is required in order for the stream to work properly.
8. Return to the Facebook **Stream Setup** tab.
9. Click the **Copy** button, next to the **Stream Key** field.

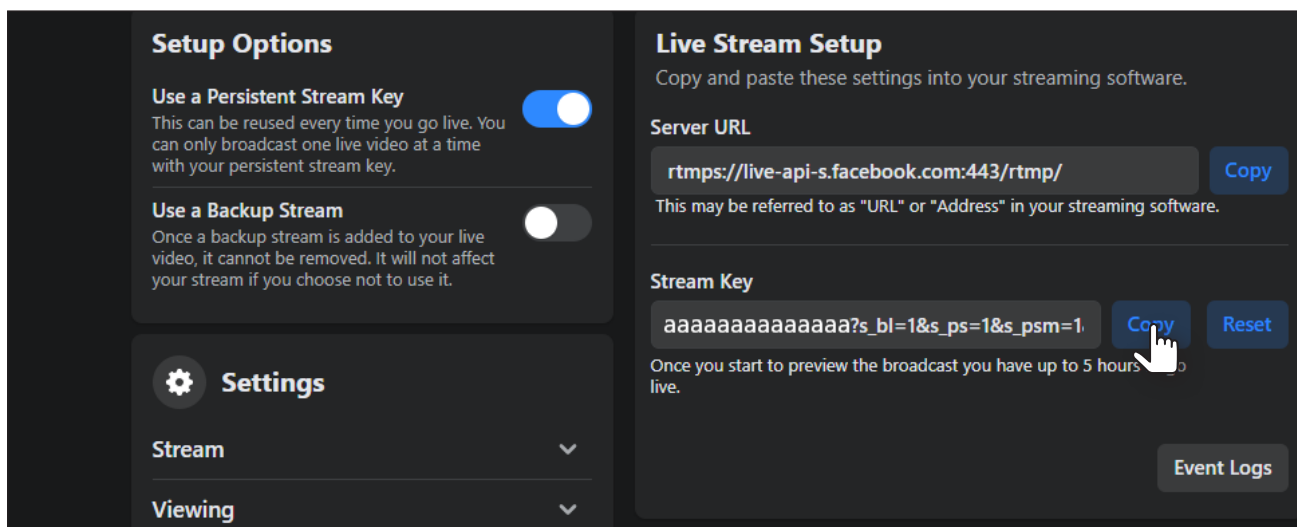

10. Paste the contents from the **Stream Key** field, on Facebook, to the **Stream Key** field in the camera web interface. Make sure that the contents are pasted into the correct field. Refer to the User Manual for the AT-HDVS-CAM-HDMI for information on **Main Stream** and **Sub Stream** configuration.

Publish Settings

Main Stream

Enable

Protocol Type RTMP

Host Address 192.168.5.11

Host Port 1935

Stream Key live/av0

Sub Stream

Enable

Protocol Type RTMP

Host Address rtmps://live-api-s.facebook.com:44

Host Port 443

Stream Key aaaaaaaaaaaaaaaa?s_bl=1&s_p

Save
Cancel

Stream Key

11. Click the **Save** button to commit changes.
12. Return to the Facebook **Stream Setup** tab and scroll up to preview the video stream. Note that it may take a few moments for the video stream to buffer and be displayed.
13. To begin broadcasting the video, click the **Go Live** button, located in the bottom-left corner of the screen.

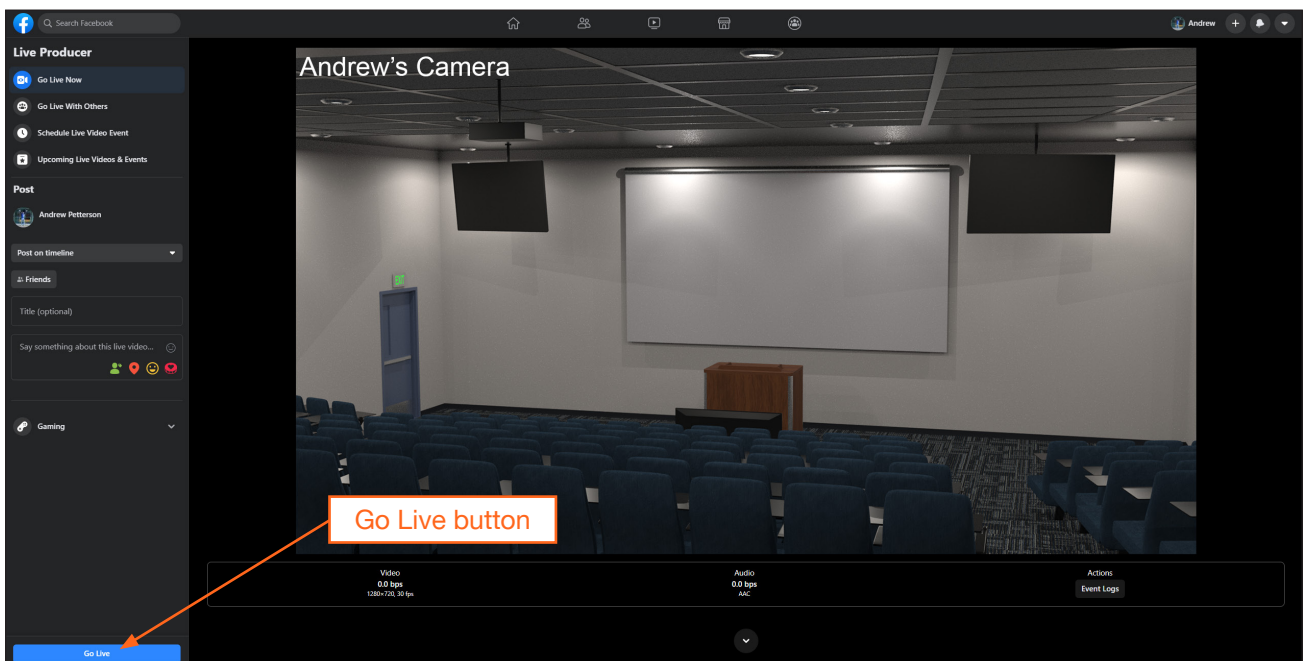

Using YouTube Live

This section provides step-by-step instructions on how to display a stream using YouTube Live. Before proceeding, make sure that both the Main Stream and Sub Stream are properly configured. Refer to the User Manual for more information.

1. Launch a web browser and login to your YouTube account.
2. In the upper-right corner of the screen, click the **Create** icon (camera), then click **Go Live**.

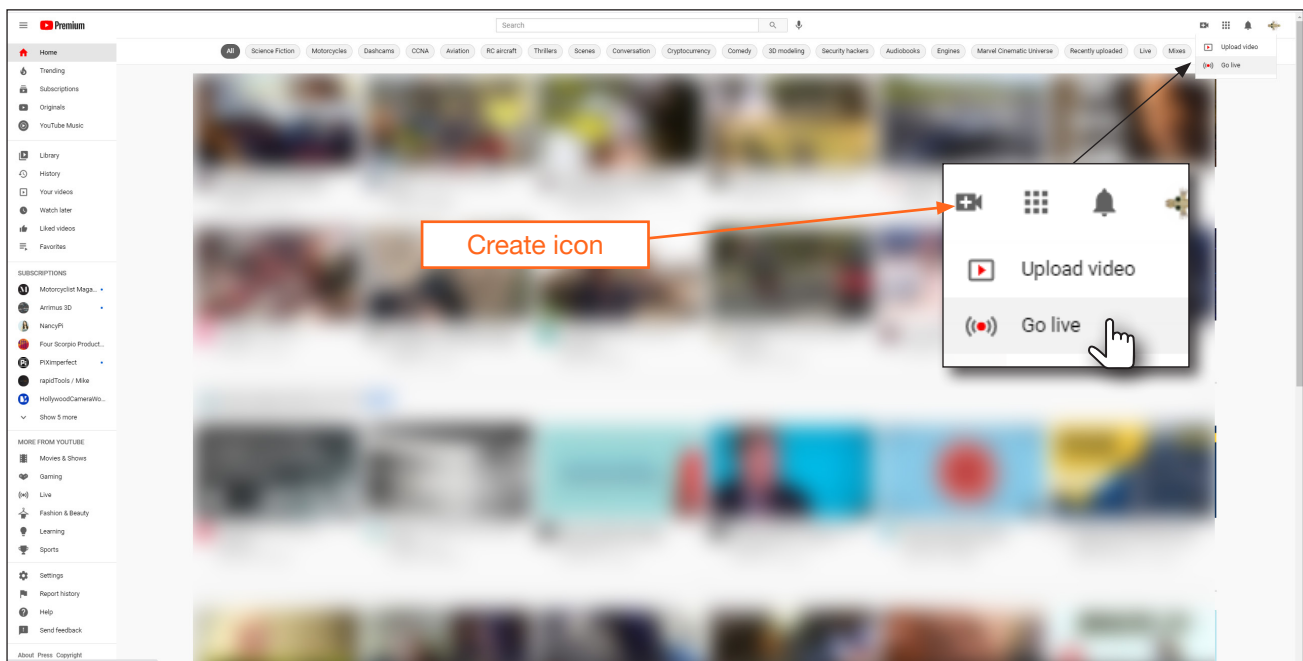

3. Under the **YouTube Studio** page, click the **START** button next to either **Right now** or **Later date**. In this example, the **Right now** option will be selected.

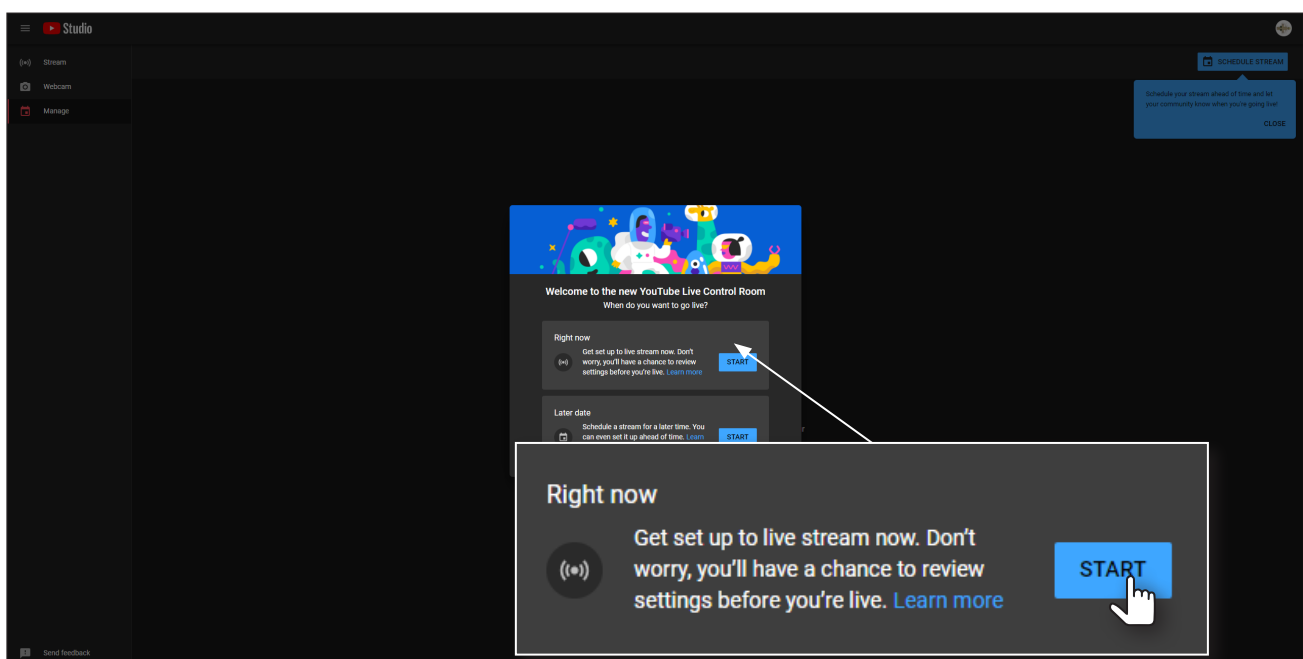

- The next screen will provide the option of selecting a **Built-in webcam** or **Streaming software**. Click the **Go** button next to **Streaming software**.

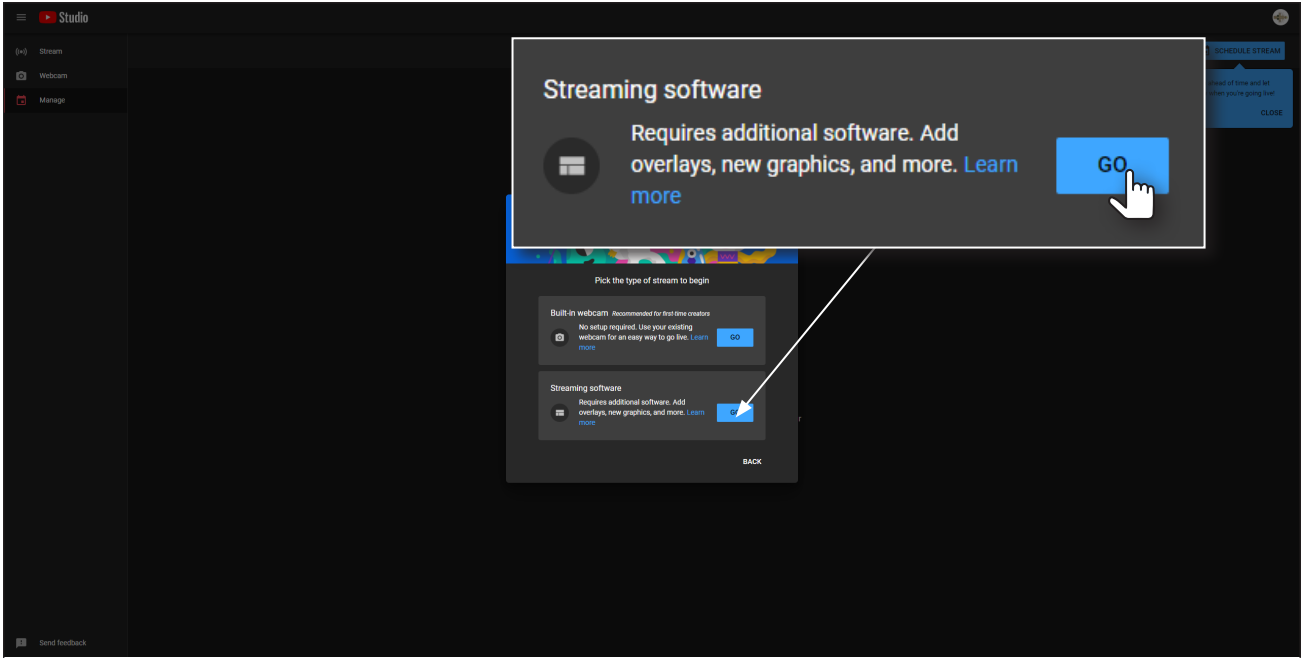

- Set the desired settings in the **Edit stream** dialog box.

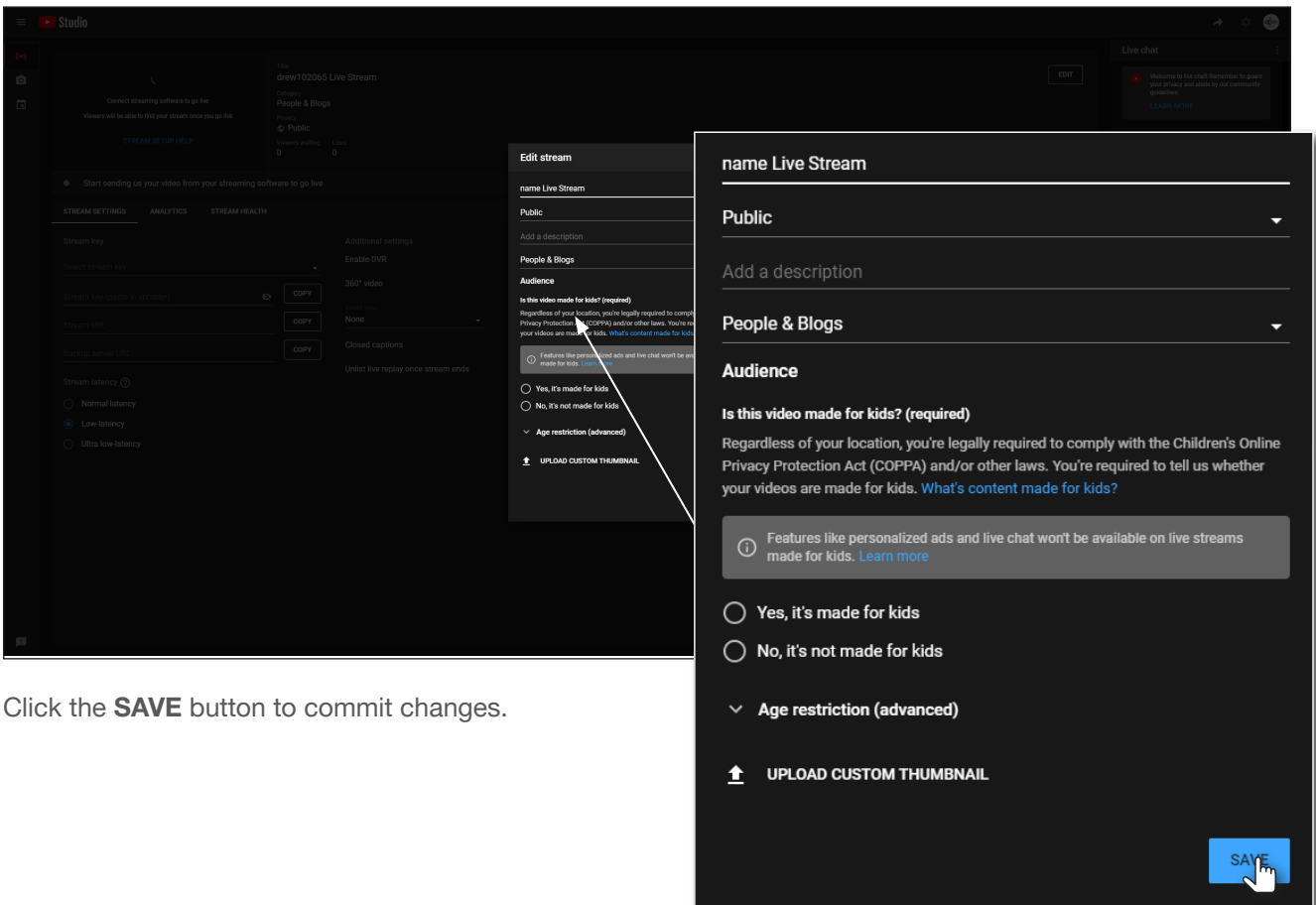

- Click the **SAVE** button to commit changes.

7. Click the **COPY** button, next to the **Stream URL** field.

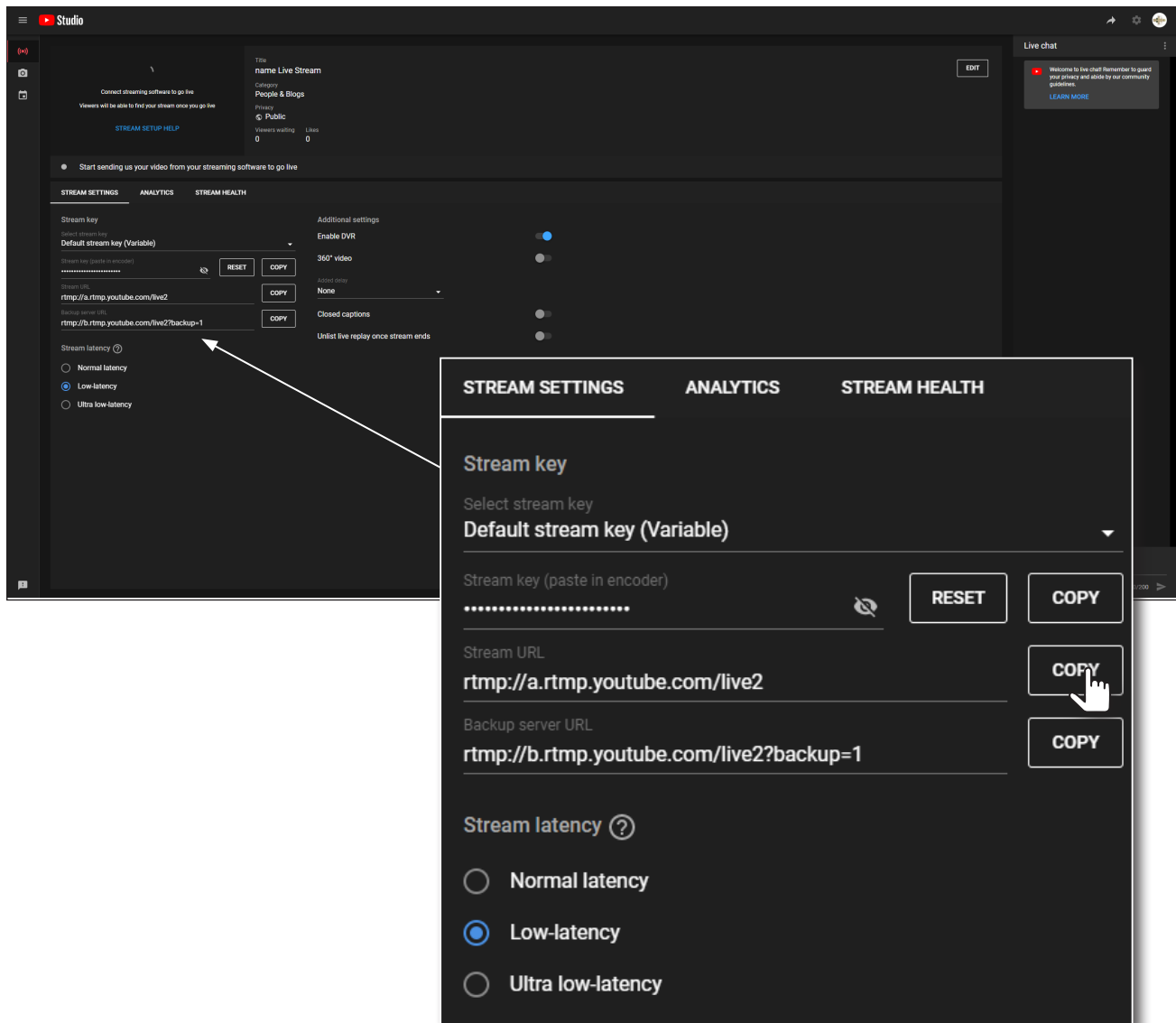

8. Go to the **Publishing** page of the AT-HDVS-CAM-HDMI web server.

- Paste the contents from the **Stream URL** field, on YouTube Live, to the **Host Address** field in the camera web interface. Note that the contents of the YouTube Live **Stream URL** field can be placed under the **Main Stream** or **Sub Stream**. Make sure that the contents are pasted into the correct field.

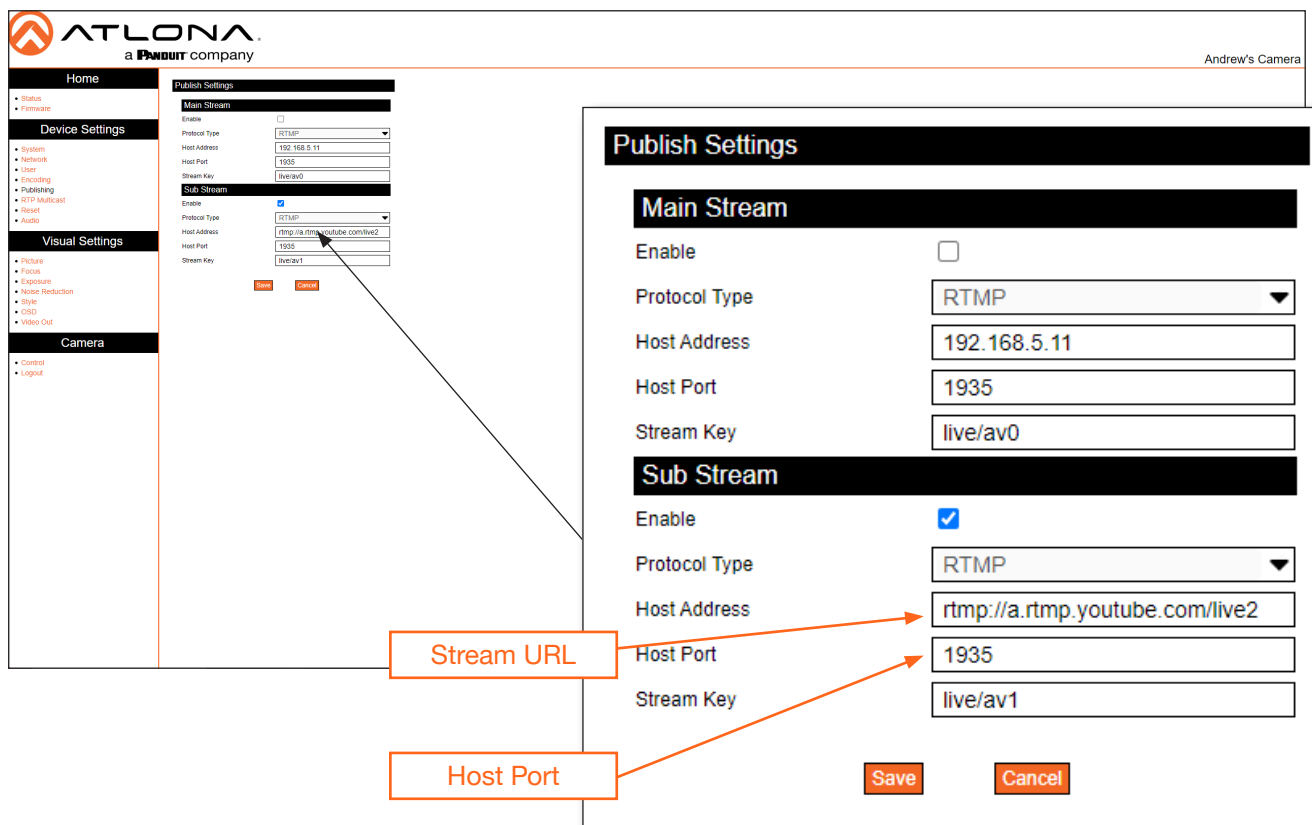

- Leave the **Host Port** field set to 1935.
- Return to the YouTube Live **Stream Settings** tab and click the **COPY** button, next to the **Stream key** field.

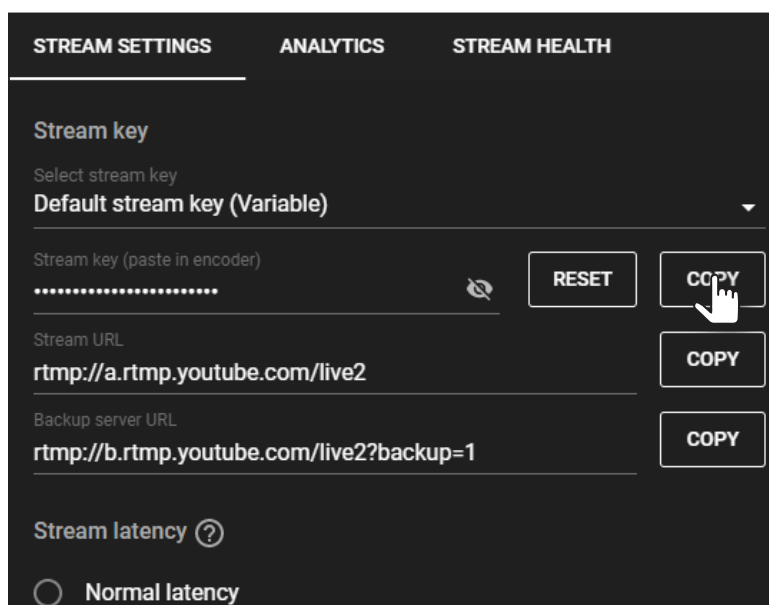

- Paste the contents from the **Stream key** field, on YouTube Live, to the **Stream Key** field in the camera web interface. Make sure that the contents are pasted into the correct field.

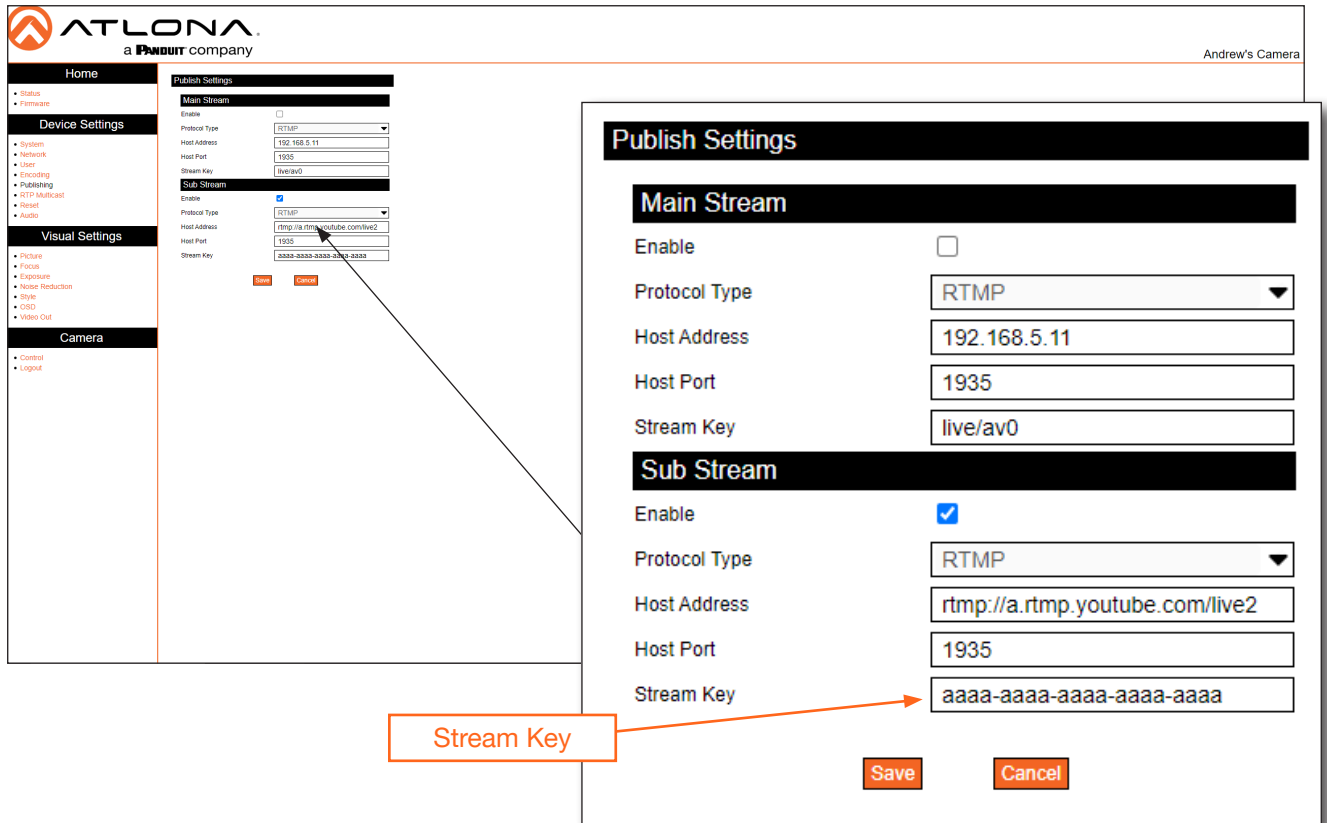

- Click the **Save** button to commit changes.
- Return to YouTube Live. The live stream preview will be displayed in the upper-left corner of the screen.
- To stop the live stream, click the **END STREAM** button in the upper-right corner of the screen.

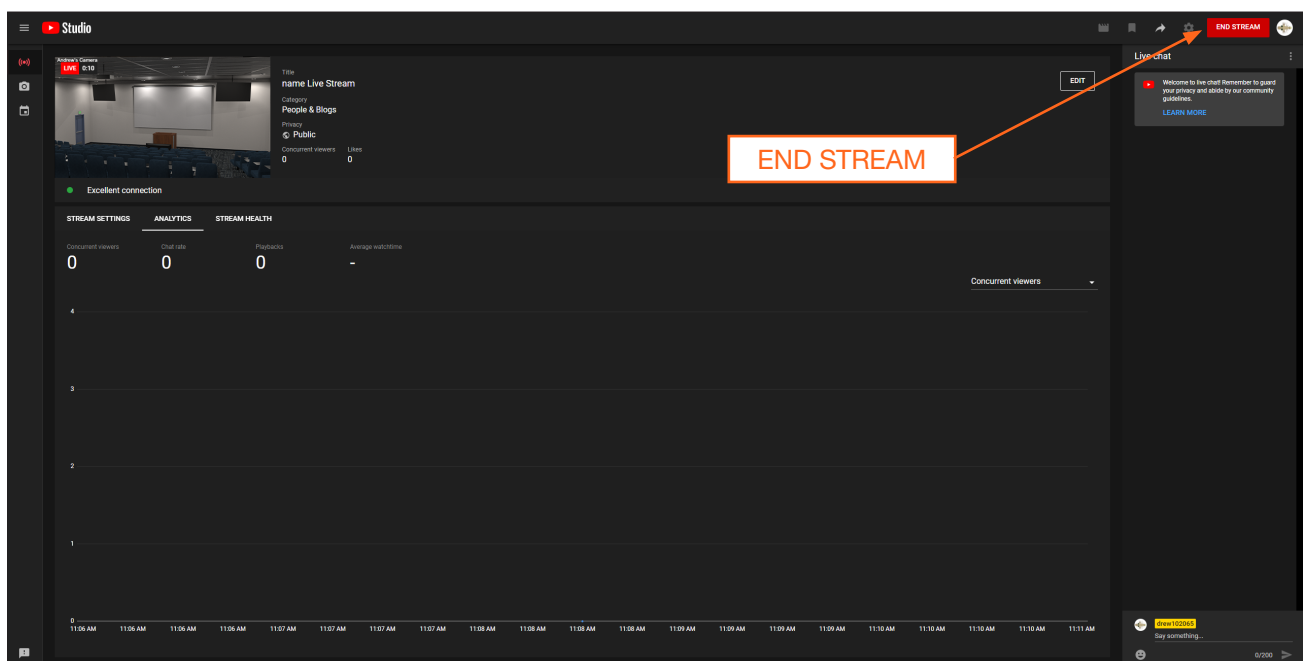

Specifications

Video	
Signal	USB
HD	1920x1080p@60/59.97/50/30/29.97/25 Hz 1920x1080i@60/59.94/50 Hz 1280x720p@60/59.94/50 Hz
Color Space	YUV, RGB
Chroma Subsampling	4:4:4, 4:2:2, 4:2:0

Streaming	
Video Compression	H.264 / H.265
Protocol	TCP, UDP, RTMP, RTSP
Bitrate	46 kbps - 40960 kbps
Compression Profiles	BP, MP, HP
Bitrate Control	VBR
Multi-Stream	Main Stream / Sub Stream (simultaneous stream output) ⁽¹⁾
Latency	175 ms

Camera	
Sensor	1/2.8" HD CMOS
Effective Pixels	16:9, 2.07 MP
Optical Zoom	$f = 4.7 \sim 47$ mm
View Angle	6.43° (telephoto), 60.9° (wide-angle)
Av	$f/1.6 - f/3.0$
Digital Zoom	10X
Minimum Illumination	0.5 lm ($f/1.8$ with AGC On)
DNR	2D / 3D
White Balance	Auto / Manual / One Push / 3000 K / 4000 K / 5000 K / 6500 K
Focus	Auto / Manual
Aperture	Auto / Manual
Electronic Shutter	Auto / Manual
BLC	ON / OFF
WDR	Off / Dynamic Level Adjustment

Camera	
Video Adjustment	Brightness, Color, Saturation, Contrast, Sharpness, B/W Mode, Gamma Curve
SNR	> 55 dB

PTZ	
Pan Rotation	$\pm 170^\circ$
Tilt Rotation	$-30^\circ \sim +90^\circ$
Pan Control Speed	0.1 - 180° / sec
Tilt Control Speed	0.1 - 80° / sec
Preset Speed	Pan: 60° / sec, Tilt: 30° / sec
Preset Number	255 (10 presets using the included IR remote control)

Connectors	
HDMI OUT	1 - Type A, 19-pin, female
USB	1 x USB, Type A
LAN	1 x RJ45, 100Base-T
RS-232	1 x 9-pin DIN
12VDC	1 x HEC3800

Temperature	Fahrenheit	Celsius
Operating	14 to 122	-10 to 50
Storage	-14 to 140	-10 to 60
Operating Humidity (RH)	20% to 80%, non-condensing	
Storage Humidity (RH)	20% to 95%, non-condensing	

Power	
Consumption	12 W
Supply	Input: 110 - 220 V AC, 50/60 Hz Output: 12 V DC, 1 A

Dimensions (H x W x D)	Inches	Millimeters
Unit	6.59 x 5.90 x 5.90	167.5 x 150 x 150
Power Supply (AT-PS-122-NL)	1.26 x 1.97 x 3.7	32.05 x 50 x 94

Weight	Pounds	Kilograms
Device	3.08	1.4

Certification	
Device	CE, FCC

Warranty	
Device	To view the product warranty, use the following link: https://atlon.com/warranty

Footnotes

- (1) Tested using VLC media player connected to the camera.

Accessories

SKU	Title
AT-HDVS-CAM-CMNT	Ceiling Mount Kit for AT-HDVS-CAM

