

# 4K/UHD HDMI Over HDBaseT TX/RX with Control and PoE

*AT-UHD-EX-70C-KIT & AT-UHD-EX-70C-RX*

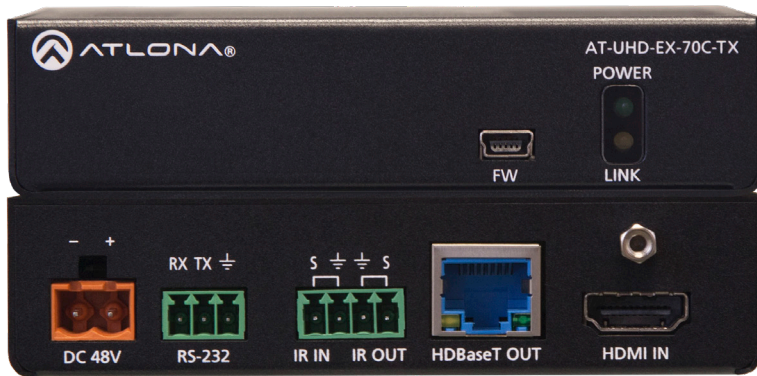

## Table of Contents

1. Introduction	3
2. Package Contents	3
3. Features	3
4. Before You Start	3
5. Category Cable	4
6. Panel Descriptions	
a. Front Panel	5
b. Rear Panel	6
7. Captive Screw Connectors	7
8. Connection Diagram	8-9
9. Specifications	10
10. Safety Information	11
11. Warranty	12-13
12. Atlona Product Registration	13

## Introduction

Pass through support of 4K (UHD), 2560x2048, IR, RS-232, and lossy/lossless audio signals up to 230ft (70m). The 70C extenders provide an affordable, high quality, solution for your audio and video needs.

## Package Contents

### Kit

- 1 x AT-UHD-EX-70C-TX
- 1 x AT-UHD-EX-70C-RX
- 1 x 48V DC desk top power supply
- 1 x IEC C13 power cable
- 5 x Female captive screw connector (2 pin (x1): power, 3 pin (x2): RS-232, and 5 pin (x2): IR)
- 2 x Pair of wall/table mount ears
- 1 x IR emitter (AT-IR-CS-TX)
- 1 x User manual

### RX

- 1 x AT-UHD-EX-70C-RX
- 2 x Female captive screw connector (3 pin: RS-232 and 5 pin: IR)
- 2 x Pair of wall/table mount ears
- 1 x IR emitter (AT-IR-CS-TX)
- 1 x User manual

## Features

- Extends IR, RS-232, and audio/visual content up to 328ft over a single category cable
- Supports resolutions up to 4K (UHD) 60Hz @ chroma sub-sampling 4:2:0 8-bit
- IR ports for use with IR remote controls and 3rd party IR controllers
- Provides PoE (Power over Ethernet) from transmitter to receiver
- Multichannel audio pass through up to Dolby TrueHD, DTS-HD Master Audio, and Dolby Atmos
- Full 3D pass through
- HDCP 2.2 compliant
- Field updatable firmware

## Before You Start

- When installing the extenders **DO NOT:**
  - Cover the vents
  - Install into a sealed wall
  - Install into an area without adequate air ventilation

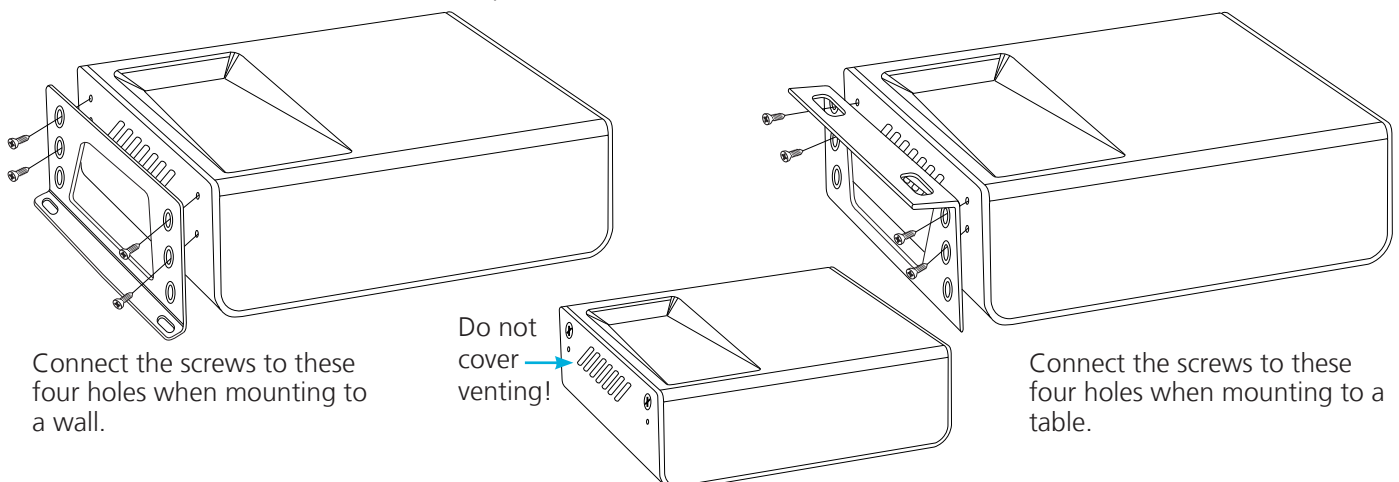

\*Remove the side screws from the case and use for bracket installation

## Category Cable

For the category cables used in the installation of these products, please be sure to use a 568B termination as pictured below:

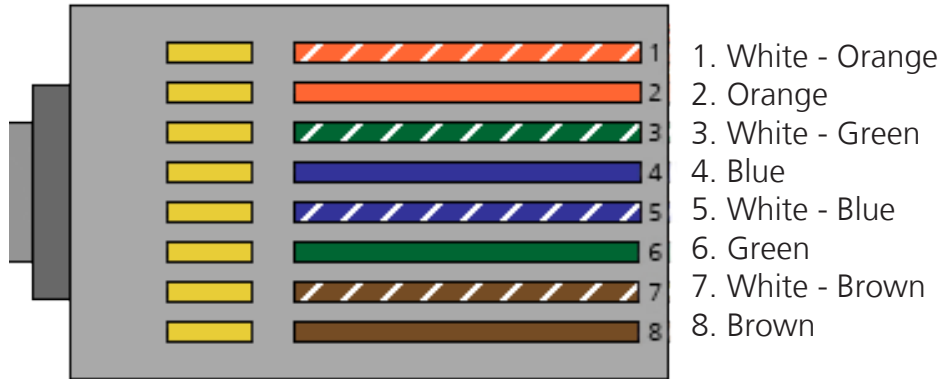

Use the table below to verify the best category cable for the installation.

Performance Rating		Type of LAN cable	
Wiring	Shielding	CAT5e/6	CAT6a/7
Solid	Shielded (STP/FTP)	***	****
	UnShielded (UTP)	**	N/A
Stranded - Patch cable (Not recommended)	Unshielded (UTP)	*	N/A
	Shielded (STP/FTP)	*	N/A
<b>Termination</b>		<b>Please use EIA/TIA-568-B termination</b>	

**Important!** 4K (UHD) signals are sensitive to cable quality and installation technique. It is recommended to use CAT6a/7 solid core cables for best results.

**Note:** For cable distances see the specifications on page 10

## Connector

Connector type and size is very important to ensure extenders work correctly. Please use the matching cable type with the correct RJ45 connector.

CAT5e and CAT 6 cables should use only CAT5e RJ45 connectors

CAT6a cables should use only CAT6a connectors

CAT7 cables should use only CAT7 connectors

Using the wrong size of connectors may result in interference causing loss of signal.

**Important!** "EZ RJ45 connectors" are not recommended with HDBaseT extenders. Doing so may result in stray EMI/RFI signals to be picked up and interfere with audio and video transmission.

## Panel Description

### TX

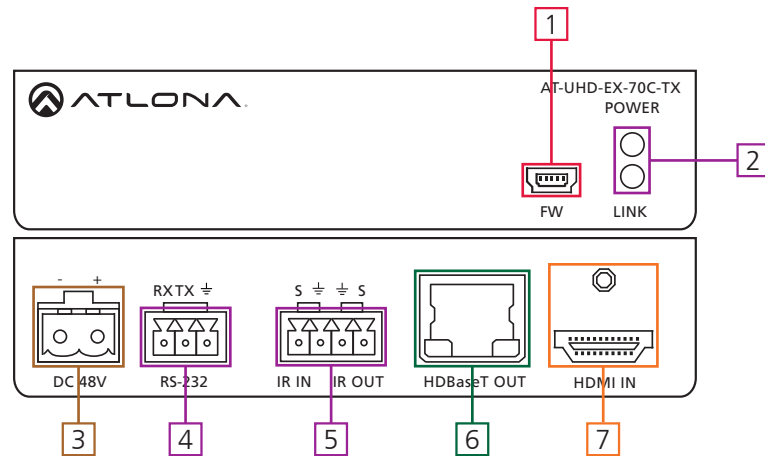

1. **Firmware** - Use a Mini-B USB to USB A cable to connect to a Windows computers for updating
2. **Yellow Link LED:** Signal indicator for the HDBaseT OUT port  
 Solid - Good signal from the HDBaseT port  
 Blinking - HDBaseT port is disconnected or not transmitting signals  
 No Light - No signal is being received from the HDBaseT port
- Green Power LED:** Power indicator  
 Solid - Plugged in and receiving power  
 Blinking - Power is intermittent or there is a problem with the cable  
 No Light - No power is passing from the wall outlet to the transmitter (check the cable or outlet)
3. **DC 48V** - Connect included captive screw power adapter here
4. **RS-232** - Bidirectional RS-232, send signal to or from a control system, PC, source, or display
5. **IR** - Connect IR emitter (included) or 3rd party control box to this port
6. **HDBaseT OUT** - Connect a category cable from here to an AT-UHD-EX-70C-RX (included in KIT)
7. **HDMI IN** - Connect HDMI or DVI (with adapter) source here  
 Ex. Blu-ray player, cable box, HDDA series, H2H series, etc

**RX**

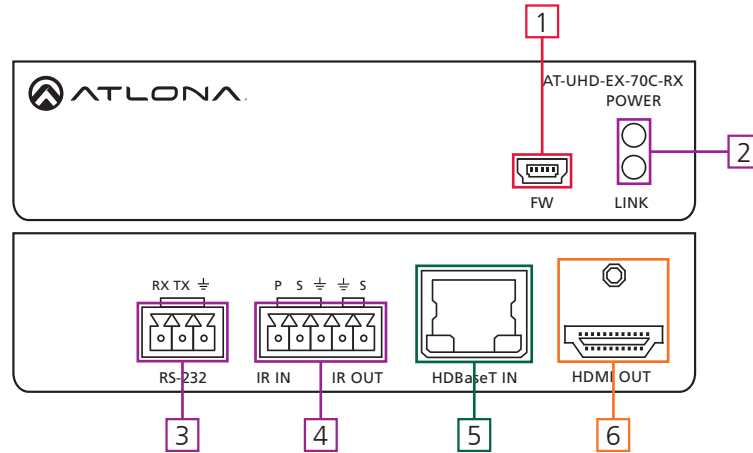

1. Firmware - Use a Mini-B USB to USB A cable to connect to a Windows computers for updating
2. Yellow Link LED: Signal indicator for the HDBaseT IN port
  - Solid - Good signal from the HDBaseT port
  - Blinking - HDBaseT port is disconnected or not receiving a signal
  - No Light - No signal is being received from the HDBaseT port
- Green Power LED: Power indicator
  - Solid - Plugged in and receiving power
  - Blinking - Power is intermittent or there is a problem with the cable
  - No Light - No power is passing from the transmitter to the receiver

Note: Check the category cable or the AC outlet for the transmitter
3. RS-232 - Bidirectional RS-232, send signal to or from a control system, PC, source, or display
4. IR - Connect IR emitter (included) or receiver (AT-IR-CS-RX sold separately) to this port
5. HDBaseT IN - Connect a category cable from here to an AT-UHD-EX-70C-TX (included in KIT) or HDBaseT matrix
6. HDMI OUT - Connect HDMI or DVI (with adapter) display here

## Captive Screw

Captive screw connectors are an added feature on the UHD extender. The captive screw connectors allow you to cut cables down to a suitable length, reducing cable clutter while providing a more reliable connection.

### Connecting

When connecting the cables to the female captive screw connector it is important that the wires be terminated correctly. The female captive screw connector has a contact plate at the top and must have the wires touching it for signal to pass. When wired correctly (see picture A) the signal will pass, incorrectly (see picture B) no signal will pass.

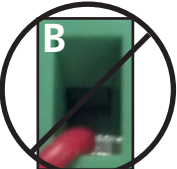



The captive screw connectors have a contact bar that is adjusted to compress the wire against the top contact plate. Use the screws at the top of the connector to compress the wire against the contact plate.



**Clockwise**

Turn the screws clockwise to raise the contact bar to the upper contact plate and hold the wires in place.



**Counter Clockwise**

Turn the screws counter clockwise to lower the contact bar to release the wires.

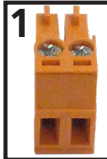

**1**  
Power

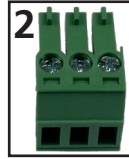

**2**  
RS-232

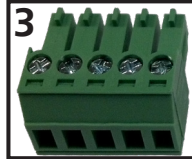

**3**  
IR

Female captive screw connectors are included: Power (see picture 1), RS-232 (see picture 2), and IR (see picture 3).



**4**

The power cable (picture 4) will have exposed wires. Each wire is encased in a different colored cover.

**Black: - White: +**

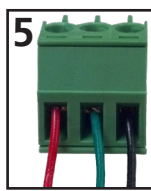

**5**

Pin out color will differ per RS-232 cable.



RS-232 pin out will be determined by the RS-232 cable and will connect as Rx (receiver), Tx (transmitter), and  $\perp$  (ground). (See picture 5)

**Note:** The IR receiver is optional for the UHD-EX-70C-KIT and RX box. The compatible IR receiver (AT-IR-CS-RX) can be purchased through [atlonac.com](http://atlonac.com).

The wires of the emitter and receiver have been marked to differentiate the pin outs.

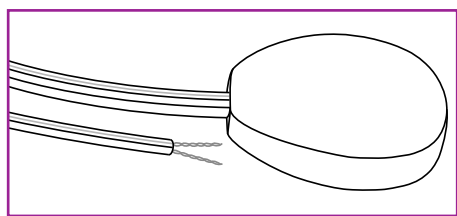

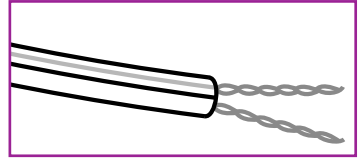

— Signal (S)  
— Ground ( $\perp$ )

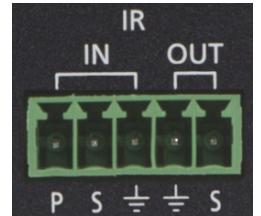

The included IR emitter has two wires: signal and ground. Signal will have a solid line and ground will be blank. The IR emitter will plug into the IR OUT ports.

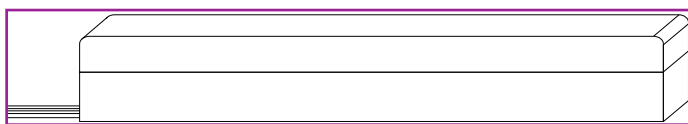

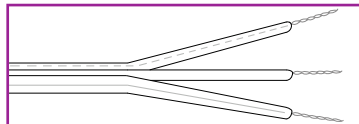

— Signal (S)  
— Ground ( $\perp$ )  
— Power (P)

There are three wires on the IR receiver (sold separately): signal, ground, and power. Signal has a dotted line, ground will be blank, and power will have a solid line. The IR receiver will plug into the IR IN ports.

## Power Chaining

Multiple kits can be powered by one power supply. The included power supply can support up to 3 kits. To power four kits use the optional power supply AT-PS-483125-C (purchase through [atlona.com](http://atlona.com)).

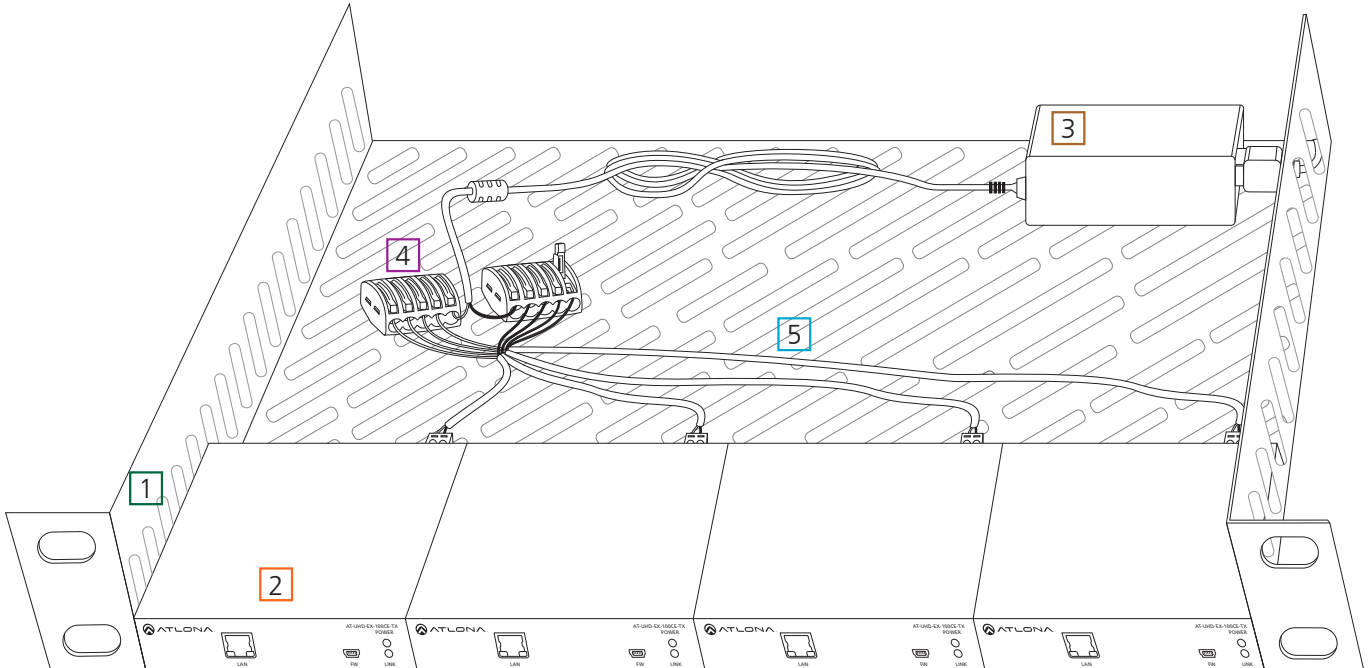

To chain one power supply to three transmitters (four when using AT-PS-483125-C), use two wago splicing connectors, 18/2 AWG stranded wire, a ventilated 1 RU rack shelf, zip ties, and high temperature hook and loop (velcro) strips will be needed.

1. 1 RU rack shelf - Should be at least 10in / 254mm deep, fit in a standard 19" rack, and must be well ventilated. Use the rack screws (included with 19" racks) to secure the rack shelf to the back/front of the rack after power chaining set up is completed.
2. Transmitters - Place 3 or 4 units on the rack shelf. Use high temperature (up to 185°F / 85°C) hook and loop (velcro) to secure the transmitters to the rack.
3. Power supply - Place the included power supply (or the AT-PS-483125-C) on the rack with enough room to connect the included IEC power cable. Use twist ties to secure the power supply and cable to the rack.
4. Wago splicing connectors - Connect the wires from the power supply cable to the wago splicers. Connect the white wire (power/+) to one splicer and the black wire (ground/-) to the second splicer.  
**Note:** Only one wire per port.
5. 18/2 AWG stranded wire - Connect the individual wires to the wago splicers and the transmitter captive screw connectors. There will be two colors of wires (black/red) which will need to be designated - and +. Each color will need to be the same across all connections to ensure no signals are crossed. Strip the ends of each wire and place one end in the appropriate wago connector and the other to the corresponding captive screw connector. Use the zip ties to keep all wires in place and organized.

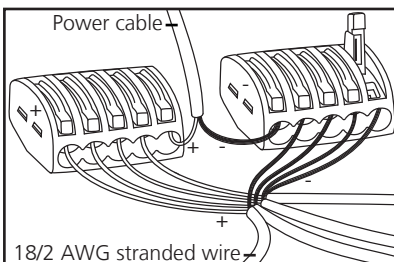



# Connection Diagram (Kit connections)

- Video
- HDBaseT
- Control
- Ethernet

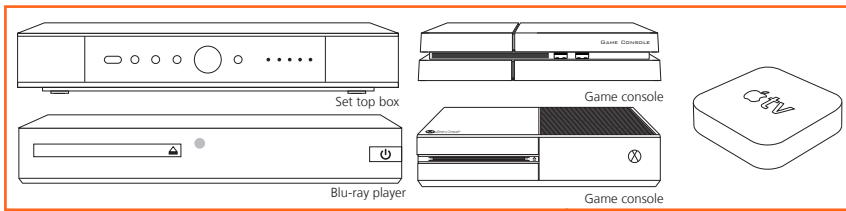
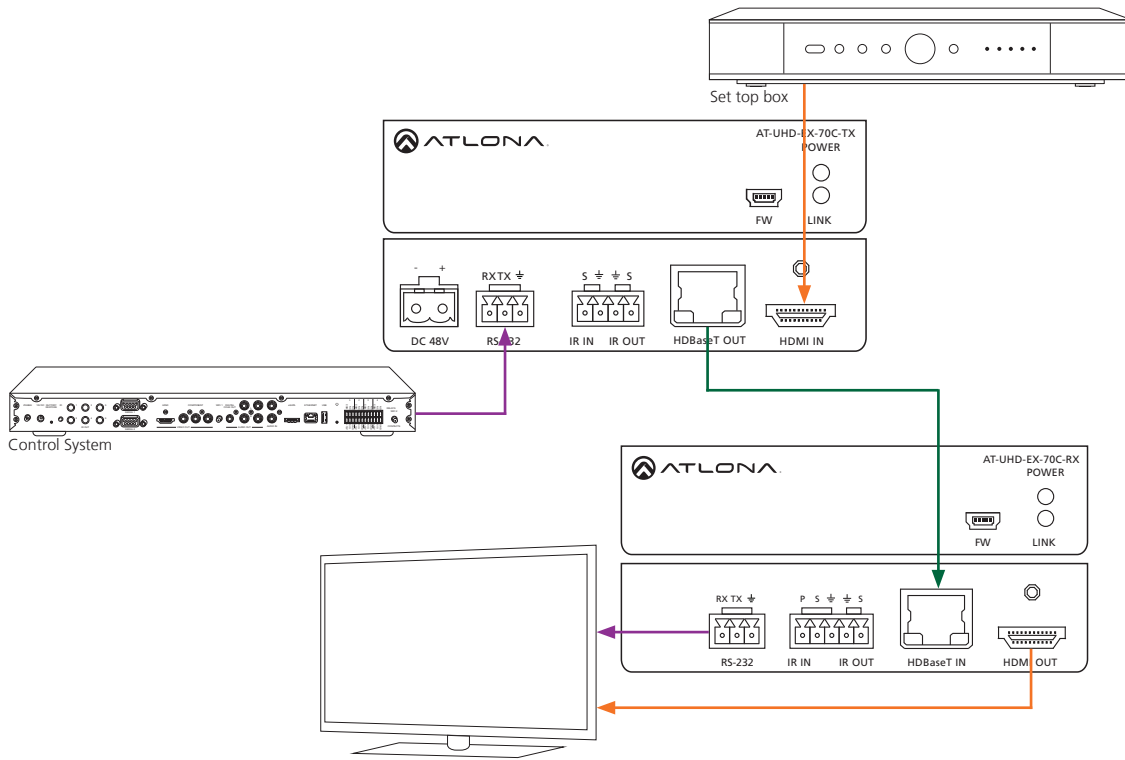

- Video
- HDBaseT
- Control

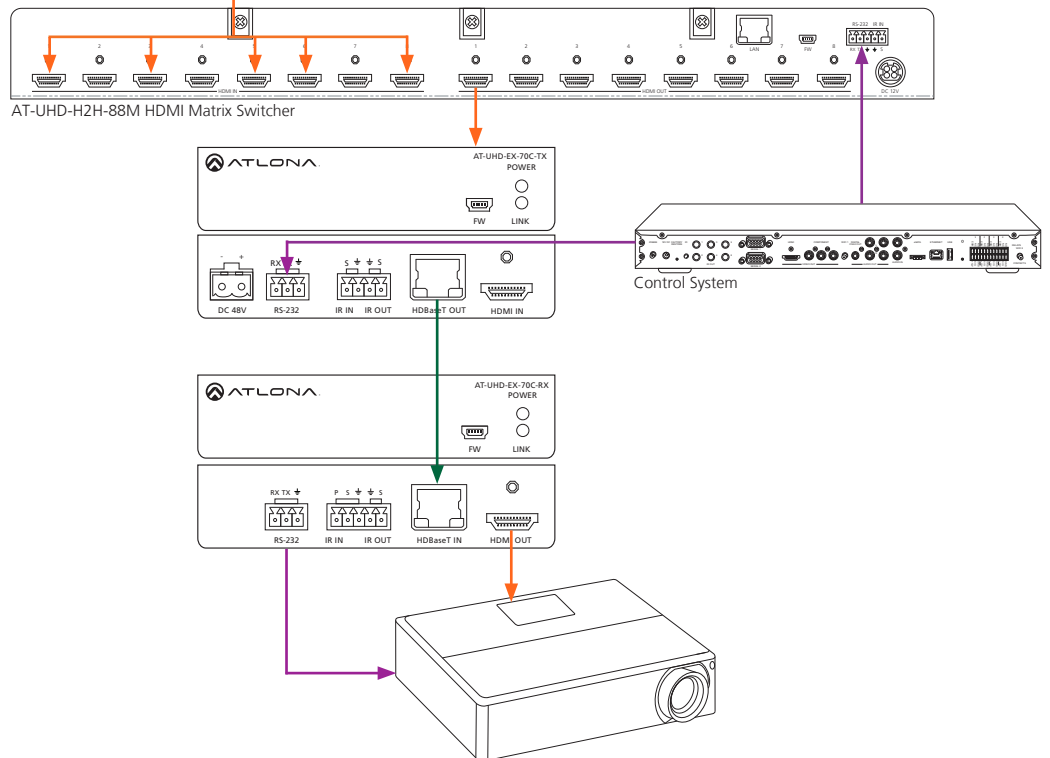

# Connection Diagram (RX connection)

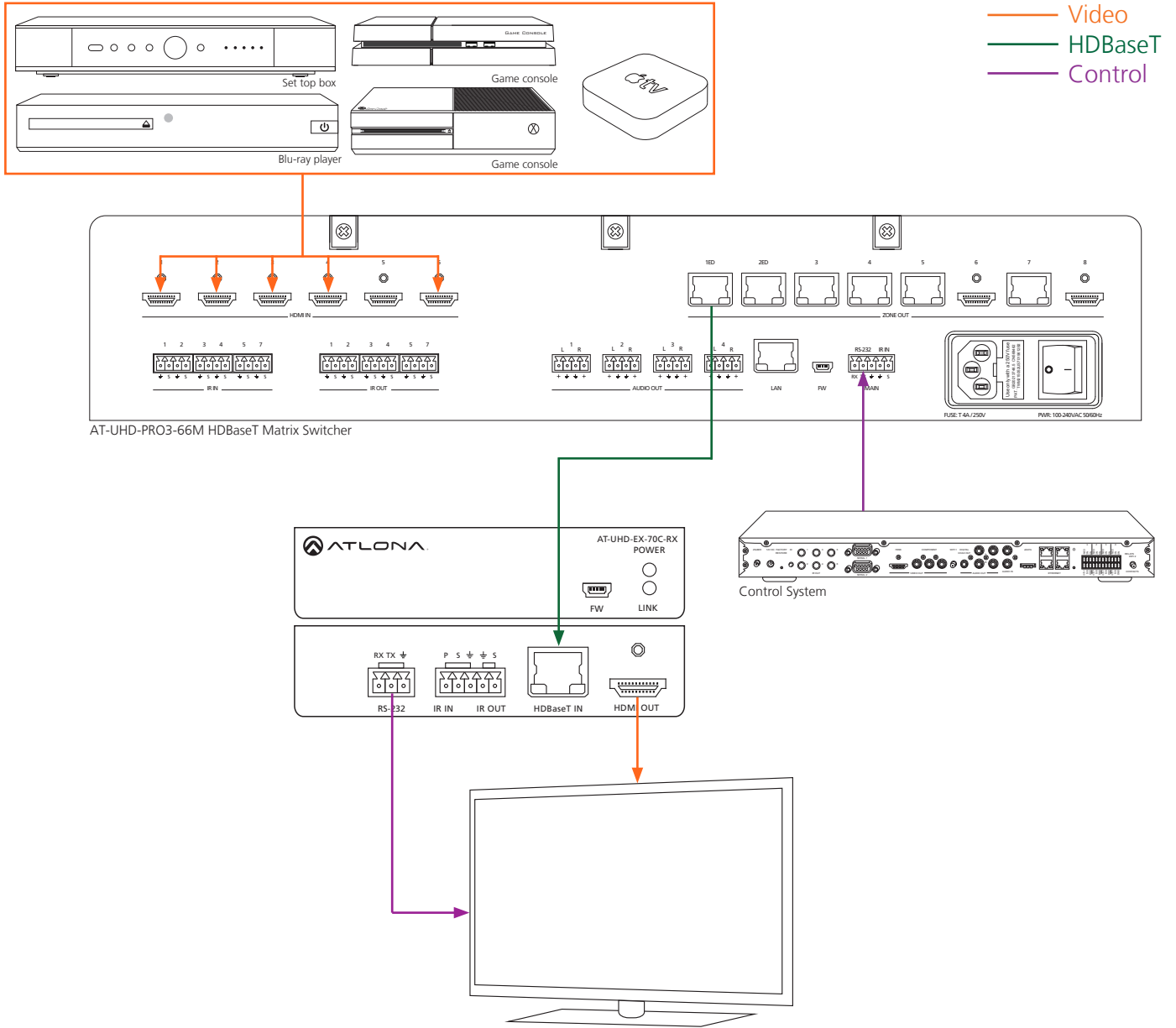

## Specifications

### Video Resolutions

Video	4096x2160@24/25/30/50*/60Hz*, 3840x2160@24/25/30/50*/60Hz* (UHD), 2048x1080p, 1080p@23.98/24/25/29.97/30/50/59.94/60Hz, 1080i@50/59.94/60Hz, 720p@50/59.94/60Hz, 576p, 576i, 480p, 480i	
VESA	2560x2048, 2560x1600, 2048x1536, 1920x1200, 1680x1050, 1600x1200, 1600x900, 1440x900, 1400x1050, 1366x768, 1360x768, 1280x1024, 1280x800, 1280x768, 1152x768, 1024x768, 800x600, 640x480	
Colorspace	YCbCr, RGB	
Chroma Subsampling	4:4:4, 4:2:2, 4:2:0*	
Color depth	8-bit, 10-bit, 12-bit	

### Audio

Format - pass through	PCM 2Ch, LPCM 5.1, LPCM 7.1, Dolby Digital, DTS 5.1, Dolby Digital Plus, Dolby TrueHD, DTS-HD Master Audio, Dolby Atmos	
Sample Rate	32kHz, 44.1kHz, 48kHz, 88.2kHz, 96kHz, 176.4kHz, 192kHz	
Bit rate	up to 24-bit	

### Distance

CAT5e/6 @ 4K	up to 35M	up to 115 ft
CAT6a/7 @ 4K	up to 40M	up to 130 ft
CAT5e/6 @ 1080p	up to 60M	up to 197 ft
CAT6a/7 @ 1080p	up to 70M	up to 230 ft
HDMI IN/OUT @ 4K	up to 5M	up to 15 ft
HDMI IN/OUT @ 1080p	up to 10M	up to 30 ft

### Signal

Bandwidth	10.2 Gbps	
CEC	Yes	
HDCP	supports up to 2.2	

### Temperature

Operating	0°C to 50°C	32°F to 122°F
Storage	-20°C to 60°C	-4°F to 140°F
Humidity	20 to 90% non-condensing	

### Power

Consumption - Kit Supply	8.54W (paired) Input: AC100~240V 50/60Hz Output: DC48V 0.83A	
--------------------------	--	--

### Dimension

H x W x D	26 x 109 x 89 (mm)	1.02 x 4.29 x 3.50 (inch)
w/ears	28 x 119 x 89 (mm)	1.10 x 4.69 x 3.50 (inch)

### Weight

TX	0.27 kg	0.59 lbs
RX	0.33 kg	0.73 lbs

### Certification

Power Supply	CE, FCC, cULus, RoHS, CCC, RCM	
Product	CE, FCC	

\*\*4096x2160@50/60Hz & 3840x2160@50/60Hz supported @ chroma subsampling 4:2:0 8-bit only

## Safety Information

### Safeguards



To reduce the risk of electric shock, do not expose this product to rain or moisture



Do not modify the wall plug. Doing so will void the warranty and safety features.



If the wall plug does not fit into your local power socket, hire an electrician to replace your obsolete socket.



This equipment should be installed near the socket outlet and the device should be easily accessible in the case it requires disconnection.

### Precautions

FCC regulations state that any unauthorized changes or modifications to this equipment, not expressly approved by the manufacturer, could void the user's authority to operate this equipment.

Operate this product using only the included external power supply. Use of other power supplies could impair performance, damage the product, or cause fires.

In the event of an electrostatic discharge this device may automatically turn off. If this occurs, unplug the device and plug it back in.

Protect and route power cords so they will not be stepped on or pinched by anything placed on or against them. Be especially careful of plug-ins or cord exit points from this product.

Avoid excessive humidity, sudden temperature changes or temperature extremes.

Keep this product away from wet locations such as bathtubs, sinks, laundries, wet basements, fish tanks, and swimming pools.

Use only accessories recommended by Atlona to avoid fire, shock, or other hazards.

Unplug the product before cleaning. Use a damp cloth for cleaning and not cleaning fluid or aerosols. Such products could enter the unit and cause damage, fire, or electric shock. Some substances may also mar the finish of the product.

Never open, remove unit panels, or make any adjustments not described in this manual. Attempting to do so could expose you to dangerous electrical shock or other hazards. It may also cause damage to your product. Opening the product will void the warranty.

Do not attempt to service the unit. Disconnect the product and contact your authorized Atlona reseller or contact Atlona directly.

## Atlona, Inc. ("Atlona") Limited Product Warranty Policy

### Coverage

Atlona warrants its products will substantially perform to their published specifications and will be free from defects in materials and workmanship under normal use, conditions and service.

Under its Limited Product Warranty, Atlona, at its sole discretion, will either:

- A) repair or facilitate the repair of defective products within a reasonable period of time, restore products to their proper operating condition and return defective products free of any charge for necessary parts, labor and shipping
- OR**
- B) replace and return, free of charge, any defective products with direct replacement or with similar products deemed by Atlona to perform substantially the same function as the original products
- OR**
- C) refund the pro-rated value based on the remaining term of the warranty period, not to exceed MSRP, in cases where products are beyond repair and/or no direct or substantially similar replacement products exist.

Repair, replacement or refund of Atlona's products is the purchaser's exclusive remedy and Atlona's liability does not extend to any other damages, incidental, consequential or otherwise.

This Limited Product Warranty extends to the original end-user purchaser of Atlona's products and is non-transferrable to any subsequent purchaser(s) or owner(s) of these products.

### Coverage Periods

Atlona's Limited Product Warranty Period begins on the date of purchase by the end-purchaser. The date contained on the end-purchaser's sales or delivery receipt is the proof purchase date.

#### **Limited Product Warranty Terms – New Products**

- 10 years from proof of purchase date for hardware/electronics products purchased on or after June 1, 2013
- 3 years from proof of purchase date for hardware/electronics products purchased before June 1, 2013
- Lifetime Limited Product Warranty for all cable products

#### **Limited Product Warranty Terms – Refurbished (B-Stock) Products and Discontinued Products**

- 3 years from proof of purchase date for all Refurbished (B-Stock) and Discontinued hardware and electronic products purchased on or after June 1, 2013

### Remedy

Atlona recommends that end-purchasers contact their authorized Atlona dealer or reseller from whom they purchased their products. Atlona can also be contacted directly. Visit [www.atlona.com](http://www.atlona.com) for Atlona's contact information and hours of operation. Atlona requires that a dated sales or delivery receipt from an authorized dealer, reseller or end-purchaser is provided before Atlona extends its warranty services. Additionally, a return merchandise authorization (RMA) and/or case number, is required to be obtained from Atlona in advance of returns.

Atlona requires that products returned are properly packed, preferably in the original carton, for shipping. Cartons not bearing a return authorization or case number will be refused. Atlona, at its sole discretion, reserves the right to reject any products received without advanced authorization. Authorizations can be requested by calling 1-877-536-3976 (US toll free) or 1-408-962-0515 (US/international) or via Atlona's website at [www.atlona.com](http://www.atlona.com).

### Exclusions

This Limited Product Warranty excludes:

- Damage, deterioration or malfunction caused by any alteration, modification, improper use, neglect, improper packing or shipping (such claims must be presented to the carrier), lightning, power surges, or other acts of nature.
- Damage, deterioration or malfunction resulting from the installation or removal of this product from any installation, any unauthorized tampering with this product, any repairs attempted by anyone unauthorized by Atlona to make such repairs, or any other cause which does not relate directly to a defect in materials and/or workmanship of this product.
- Equipment enclosures, cables, power supplies, batteries, LCD displays, and any accessories used in conjunction with the product(s).
- Products purchased from unauthorized distributors, dealers, resellers, auction websites and similar unauthorized channels of distribution.

### **Disclaimers**

This Limited Product Warranty does not imply that the electronic components contained within Atlona's products will not become obsolete nor does it imply Atlona products or their electronic components will remain compatible with any other current product, technology or any future products or technologies in which Atlona's products may be used in conjunction with. Atlona, at its sole discretion, reserves the right not to extend its warranty offering in instances arising outside its normal course of business including, but not limited to, damage inflicted to its products from acts of god.

### **Limitation on Liability**

The maximum liability of Atlona under this limited product warranty shall not exceed the original Atlona MSRP for its products. To the maximum extent permitted by law, Atlona is not responsible for the direct, special, incidental or consequential damages resulting from any breach of warranty or condition, or under any other legal theory. Some countries, districts or states do not allow the exclusion or limitation of relief, special, incidental, consequential or indirect damages, or the limitation of liability to specified amounts, so the above limitations or exclusions may not apply to you.

### **Exclusive Remedy**

To the maximum extent permitted by law, this limited product warranty and the remedies set forth above are exclusive and in lieu of all other warranties, remedies and conditions, whether oral or written, express or implied. To the maximum extent permitted by law, Atlona specifically disclaims all implied warranties, including, without limitation, warranties of merchantability and fitness for a particular purpose. If Atlona cannot lawfully disclaim or exclude implied warranties under applicable law, then all implied warranties covering its products including warranties of merchantability and fitness for a particular purpose, shall provide to its products under applicable law. If any product to which this limited warranty applies is a "Consumer Product" under the Magnuson-Moss Warranty Act (15 U.S.C.A. §2301, ET SEQ.) or other applicable law, the foregoing disclaimer of implied warranties shall not apply, and all implied warranties on its products, including warranties of merchantability and fitness for the particular purpose, shall apply as provided under applicable law.

### **Other Conditions**

Atlona's Limited Product Warranty offering gives legal rights, and other rights may apply and vary from country to country or state to state. This limited warranty is void if (i) the label bearing the serial number of products have been removed or defaced, (ii) products are not purchased from an authorized Atlona dealer or reseller. A comprehensive list of Atlona's authorized distributors, dealers and resellers can be found at [www.atlona.com](http://www.atlona.com).

## **Atlona, Inc Product Registration**

Thank you for purchasing this Atlona product. - We hope you enjoy it and will take an extra few moments to register your new purchase.

Registration creates an ownership record if your product is lost or stolen and helps ensure you'll receive notification of performance issues and firmware updates.

At Atlona we respect and protect your privacy, assuring you that your registration information is completely secure. Atlona product registration is completely voluntary and failure to register will not diminish your limited warranty rights.

To register go to: <http://www.atlona.com/registration>