

# OMEGA™

## 4K/UHD 6x2 Matrix Switcher

for HDMI, USB-C, and HDBaseT with USB



## Version Information

---

Version	Release Date	Notes
3	Nov 2023	Added notes for internal USB hubs in specification table.
4	Jan 2024	Updated warranty information

## Sales, Marketing, and Customer Support

---

### Main Office

Atlona Incorporated  
70 Daggett Drive  
San Jose, CA 95134  
United States

Office: +1.408.962.0515 (US/International)

Sales and Customer Service Hours  
Monday - Friday: 6:00 a.m. - 4:30 p.m. (PST)

<https://atlona.com/>

### International Headquarters

Atlona International AG  
Tödistrasse 18  
8002 Zürich  
Switzerland  
Office: +41 43 508 4321

Sales and Customer Service Hours  
Monday - Friday: 09:00 - 17:00 (UTC +1)

## Operating Notes

---



**IMPORTANT:** Visit <https://atlona.com/product/at-ome-ps62/> for the latest firmware updates and User Manual.

## Warranty

---



To view the product warranty, use the following link or QR code:

<https://atlona.com/warranty/>.

## Important Safety Information



CAUTION: TO REDUCE THE RISK OF ELECTRIC SHOCK DO NOT OPEN ENCLOSURE OR EXPOSE TO RAIN OR MOISTURE. NO USER-SERVICEABLE PARTS INSIDE REFER SERVICING TO QUALIFIED SERVICE PERSONNEL.



The exclamation point within an equilateral triangle is intended to alert the user to the presence of important operating and maintenance instructions in the literature accompanying the product.



The information bubble is intended to alert the user to helpful or optional operational instructions in the literature accompanying the product.

1. Read these instructions.
2. Keep these instructions.
3. Heed all warnings.
4. Follow all instructions.
5. Do not use this product near water.
6. Clean only with a dry cloth.
7. Do not block any ventilation openings. Install in accordance with the manufacturer's instructions.
8. Do not install or place this product near any heat sources such as radiators, heat registers, stoves, or other apparatus (including amplifiers) that produce heat.
9. Do not defeat the safety purpose of a polarized or grounding-type plug. A polarized plug has two blades with one wider than the other. A grounding type plug has two blades and a third grounding prong. The wide blade or the third prong are provided for your safety. If the provided plug does not fit into your outlet, consult an electrician for replacement of the obsolete outlet.
10. Protect the power cord from being walked on or pinched particularly at plugs, convenience receptacles, and the point where they exit from the product.
11. Only use attachments/accessories specified by Atlona.
12. To reduce the risk of electric shock and/or damage to this product, never handle or touch this unit or power cord if your hands are wet or damp. Do not expose this product to rain or moisture.
13. Unplug this product during lightning storms or when unused for long periods of time.
14. Refer all servicing to qualified service personnel. Servicing is required when the product has been damaged in any way, such as power-supply cord or plug is damaged, liquid has been spilled or objects have fallen into the product, the product has been exposed to rain or moisture, does not operate normally, or has been dropped.



## FCC Compliance

FCC Compliance and Advisory Statement: This hardware device complies with Part 15 of the FCC rules. Operation is subject to the following two conditions: 1) this device may not cause harmful interference, and 2) this device must accept any interference received including interference that may cause undesired operation. This equipment has been tested and found to comply with the limits for a Class A digital device, pursuant to Part 15 of the FCC Rules. These limits are designed to provide reasonable protection against harmful interference in a commercial installation. This equipment generates, uses, and can radiate radio frequency energy and, if not installed or used in accordance with the instructions, may cause harmful interference to radio communications. However there is no guarantee that interference will not occur in a particular installation. If this equipment does cause harmful interference to radio or television reception, which can be determined by turning the equipment off and on, the user is encouraged to try to correct the interference by one or more of the following measures: 1) reorient or relocate the receiving antenna; 2) increase the separation between the equipment and the receiver; 3) connect the equipment to an outlet on a circuit different from that to which the receiver is connected; 4) consult the dealer or an experienced radio/TV technician for help. Any changes or modifications not expressly approved by the party responsible for compliance could void the user's authority to operate the equipment. Where shielded interface cables have been provided with the product or specified additional components or accessories elsewhere defined to be used with the installation of the product, they must be used in order to ensure compliance with FCC regulations.

## Copyright, Trademark, and Registration

© 2021 Atlona Inc. All rights reserved. "Atlona" and the Atlona logo are registered trademarks of Atlona Inc. Pricing, specifications and availability subject to change without notice. Actual products, product images, and online product images may vary from images shown here.

**HDMI**™ The terms HDMI, HDMI High-Definition Multimedia Interface, and the HDMI Logo are trademarks or registered trademarks of HDMI licensing Administrator, Inc.

Dolby, Dolby Atmos, and the double-D symbol are registered trademarks of Dolby Laboratories Licensing Corporation.

For DTS patents, see <http://patents.dts.com>. Manufactured under license from DTS, Inc. DTS, the Symbol, DTS and the Symbol together, and Digital Surround are registered trademarks and/or trademarks of DTS, Inc. in the United States and/or other countries. © DTS, Inc. All Rights Reserved.

All other trademark(s), copyright(s), and registered technologies mentioned(s) in this document are the properties of their respective owner(s).

# Table of Contents

---

<b>Introduction</b>	<b>6</b>
<b>Features</b>	<b>6</b>
<b>Package Contents</b>	<b>6</b>
<b>Panel Description</b>	<b>7</b>
<b>Installation</b>	<b>8</b>
Captive Screw Connections	8
Mounting Instructions	9
Connection Instructions	11
IP Modes	11
Connection Diagram	12
<b>Control</b>	<b>13</b>
CEC	13
RS-232	13
TCP Proxy	13
TCP/IP	13
WebGUI	13
<b>Front Panel Operation</b>	<b>14</b>
Routing	14
Basic	14
ALL	14
Presets Save	15
Presets Recall	15
Audio	16
Route	16
Volume	16
EQ	17
MIC	17
MIC Ducking	18
EDID	18
Copy	18
Set EDID Mode	19
Default	19
Saved	19
Internal	19
Info	20
<b>WebGUI</b>	<b>21</b>
I/O Settings	22
Audio	24
Display	26
RS-232	28
EDID	29
Time	30
Config	31
System	32
<b>Appendix</b>	<b>34</b>
Specifications	34

## Introduction

---

The Atlona AT-OME-PS62 is a 6x2 matrix switcher with HDMI, USB-C, and HDBaseT inputs, plus HDMI and HDBaseT outputs. Part of the Omega™ Series of integration products for modern AV communications and collaboration, the OME-PS62 features HDBaseT extension for video up to 4K/60 4:2:0, plus embedded audio, control, Ethernet, and USB over distances up to 330 feet (100 meters). The HDMI and USB-C ports support video up to UHD/60 4:4:4. The OME-PS62 is HDCP 2.2 compliant and features 4K/60 4:4:4 upscaling and downscaling for the HDMI output. The integrated USB extension addresses the challenge of connecting between USB devices at remote locations, and is ideal for software video conferencing and touch or interactive displays. The OME-PS62 includes USB 3.0 and USB-C interfaces for three host PCs, plus two peripheral devices such as a camera, microphone, speaker phone, or keyboard and mouse. The OME-PS62 is ideal for a wide range of 4K presentation applications with Omega Series transmitters and receivers, with local HDMI and USB-C sources and the optional Gain™ 60 or Gain 120 amplifiers (purchasable through [atlona.com](http://atlona.com)).

## Features

---

- Features two HDBaseT, three HDMI, and one USB-C input
- USB-C input for AV, data, and device charging
- Two selectable switching modes, including mirrored (default) HDMI and HDBaseT outputs, and matrixed outputs
- Transmits and receives audio, 4K/UHD video, and USB data up to 330 feet (100 meters) using HDBaseT
- Two USB 3.0 type B interfaces for connection to a host PC, plus two USB 3.0 type A ports for peripheral devices such as cameras, soundbars, or touch displays.
- 4K/UHD downscaling and upscaling on the HDMI output
- Supports IP, CEC, and bidirectional RS-232 to control local and remote displays
- Supplies industry standard IEEE 802.3af PoE over HDBaseT to Omega Series and other compatible transmitters and receivers
- Audio embedding and de-embedding, microphone/line level input with 48 volt phantom power and automatic ducking, and volume, mute, and five-band EQ for each output

## Package Contents

---

- 1 x AT-OME-PS62
- 1 x Captive screw connector, 6-pin
- 4 x Captive screw connector, 5-pin
- 1 x Captive screw connector, 3-pin
- 1 x USB-C cable
- 4 x Mounting screws
- 1 x Pair rack mount ears
- 4 x Feet w/rubber grips
- 1 x IEC power cord
- 1 x Installation Guide

# Panel Description

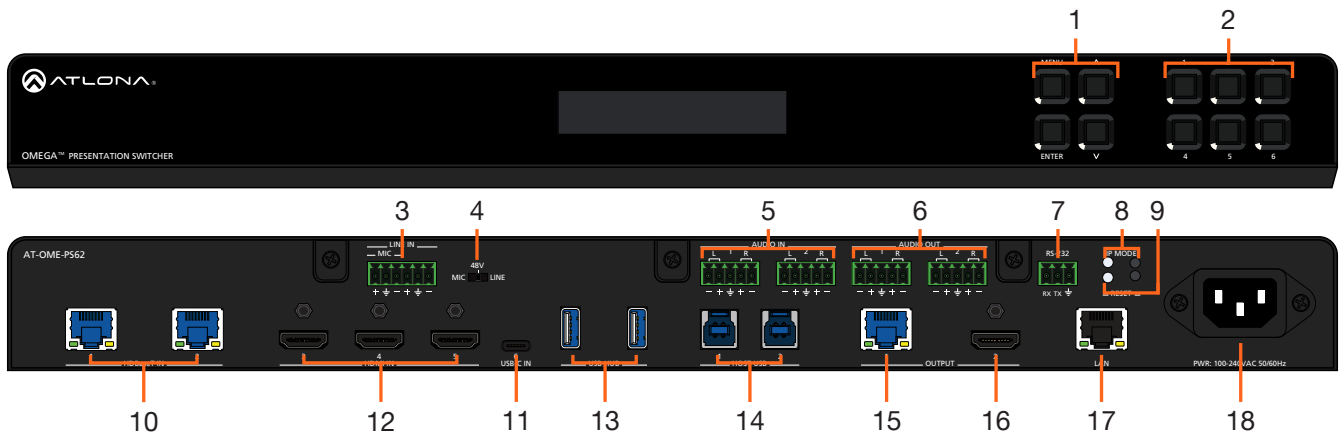

## 1 Function Buttons

**MENU** - Access the front panel menu or use as a back button within the menu. The menu can be used to route inputs, change audio and EDID settings, and view device information.

**ENTER** - Used for making selection within the front panel OSD.

**^ and v** - Use to navigate through the front panel menu.

## 2 Number Buttons

Use for selection of inputs and outputs.

## 3. MIC/LINE input

Connect microphone or line input to this port.

## 4. MIC/LINE dip switch

Use to switch between MIC, 48V, and line level input.

## 5. AUDIO IN

Connect 2CH audio sources to these ports.

## 6. AUDIO OUT

Connect to an audio DSP, amplifier, or other audio distribution devices.

## 7. RS-232

Use for device or display control.

## 8. IP MODE LED and button

Press and hold the button for 5 seconds until the LED blinks to switch the IP mode between DHCP and Static IP modes. The LED will blink 4 times for DHCP and 2 times for static IP.

## 9. RESET LED and button

Press and hold the button for 5 seconds until the unit resets. The LED will blink 3 times as the unit resets to factory default settings.

## 10. HDBaseT IN

Connect a compatible HDBaseT transmitter to this port.

## 11. HDMI IN

Connect HDMI cables to these ports from HDMI sources.

## 12. USB-C IN

Connect a USB-C source to this port.

## 13. USB HUB

Connect USB devices to these ports. **e.g.** USB camera, mouse, etc.

## 14. HOST USB

Connect to a computer using a USB B to USB A cable. USB 3.0 signal will only pass when using the local USB hub devices.

## 15. HDBaseT Output

Connect a CAT5e/6/6a/7 cable from this port to an HDBaseT receiver.

## 16. HDMI Output

Connect an HDMI cable from here to an HDMI display.

## 17. LAN

Connect an Ethernet cable to this port for control of the unit or to pass Ethernet to a local device.

## 18. 100-240VAC 50/60Hz Power Port

Connect the included IEC cord from this port to the wall for power.

# Installation

## Captive Screw Connections

### RS-232

A 3-pin captive screw connector has been included for RS-232.

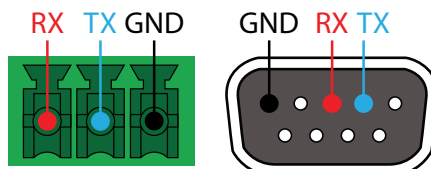
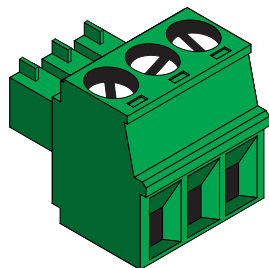

Pin out will be determined by the RS-232 cable and connect as RX (receive), TX (transmit) and  $\perp$  (Ground). Ground will be shared between port 1 and port 2.

### Audio

Connect to an audio DSP, amplifier, or other audio distribution devices.

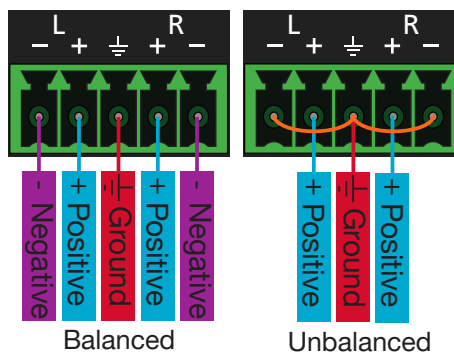
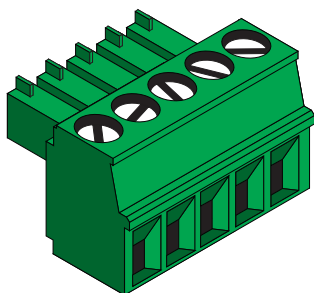

Use a jumper between the negative and ground pins when using an unbalanced connection.

### MIC / LINE



Connect dynamic or self-powered microphones in this mode.



Use this setting for phantom powered microphones. Supplies 48 volts.

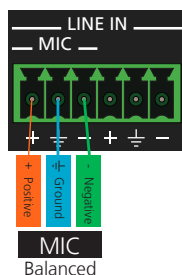

Connect wireless microphone receivers (or other sources) with line level outputs using this setting. Either balanced, unbalanced, mono, or two channel connections may be used.

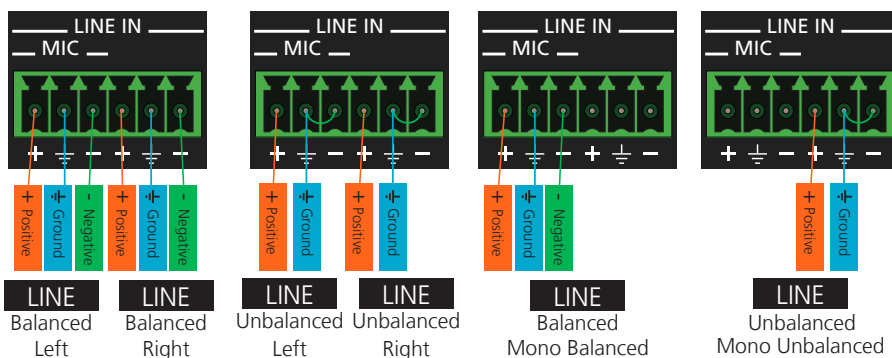



## Mounting Instructions



The AT-OME-PS62 can be mounted in a standard 19-inch rack or placed freestanding on top of a desk or table.

### Rack Installation

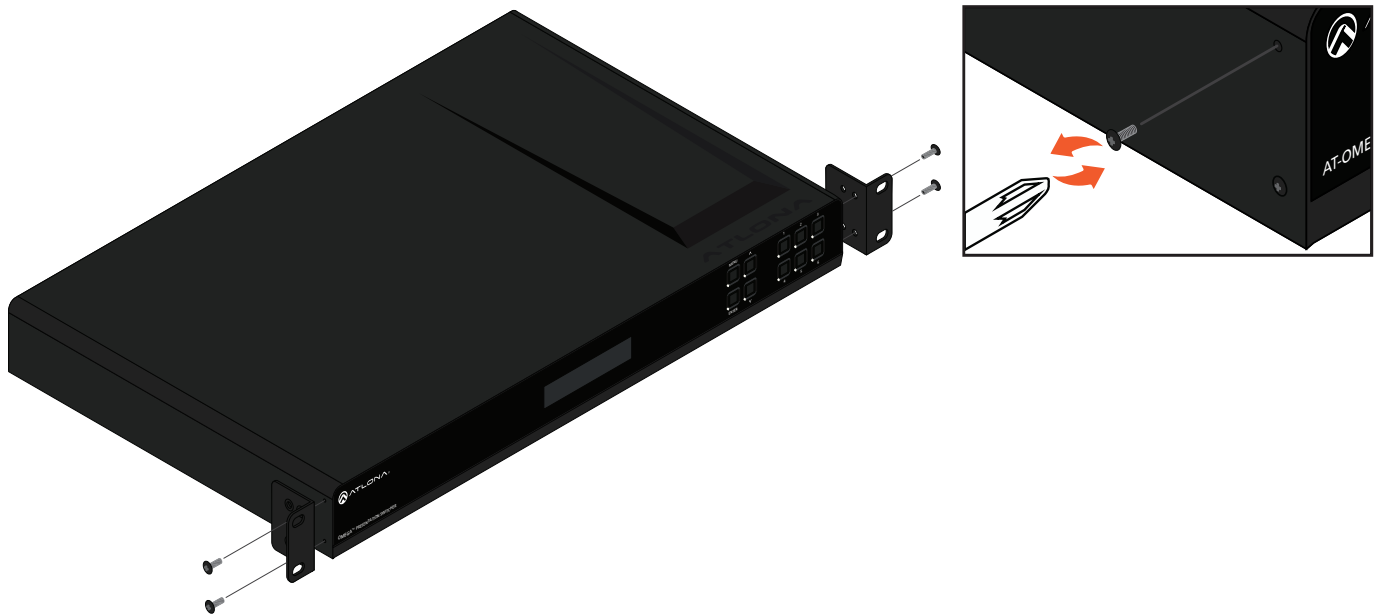
1. Remove the front two case screws from the sides of the case.
2. Attach the included rack ears to each side of the AT-OME-PS62 using the case screws.



3. Install the OME-PS62 into a rack, using four rack screws.

-  **NOTE:** Increase the air flow as needed to maintain the recommended temperature inside the rack.
-  **NOTE:** Do not exceed the maximum weight loads for the rack. Install heavier equipment in the lower part of the rack for stability.

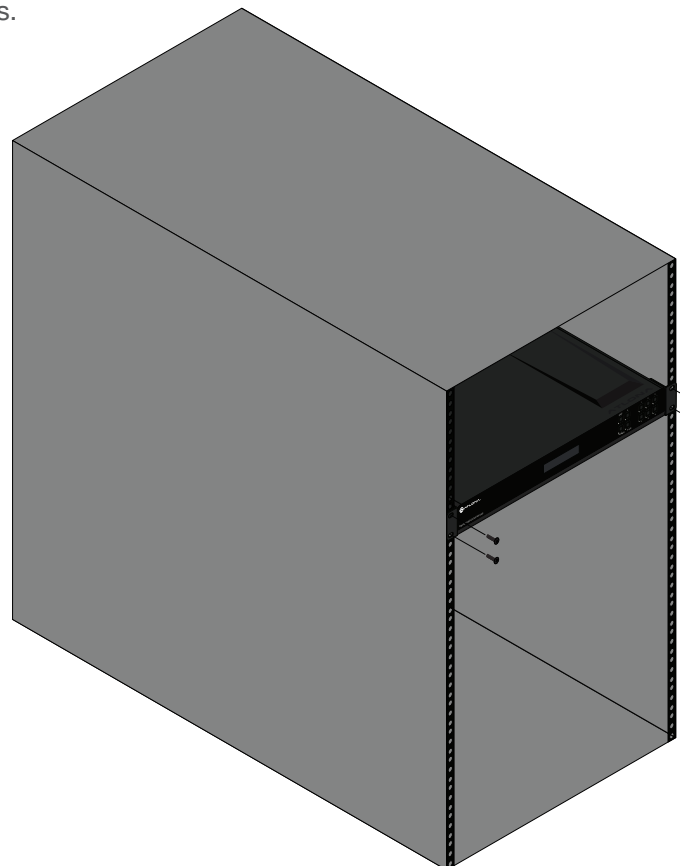

## Surface Mounting

The AT-OME-PS62 can be placed freestanding on top of a desk, a table, or in a cabinet. To prevent damage to the surfaces or unnecessary movement of the matrix, four feet have been included.

1. Turn the unit upside down.
2. Install each foot using the included feet screws, the rubber grips of the feet should be facing up during installation.
3. Turn the unit right-side up and place it in the desired location.



## Cable Recommendation Guidelines

Refer to the tables below for recommended cabling when using Altona products with HDBaseT. The green bars indicate the signal quality when using each type of cable. Higher-quality signals are represented by more bars.

Core	Shielding	CAT5e	CAT6	CAT6a	CAT7
Solid	UTP (unshielded)	■	■■■	■■■■	N/A
	STP (shielded)	■■■	■■■■■	■■■■■■	■■■■■■■
Performance Rating (MHz)		350	500	600	800

**! IMPORTANT:** Stranded or patch cables are not recommended due to performance issues.

Cable	Max. Distance @ 4K	Max. Distance @ 1080p
CAT5e	295 feet (90 meters)	330 feet (100 meters)
CAT6 / CAT6a / CAT7	330 feet (100 meters)	330 feet (100 meters)

Use of a TIA/EIA 568B termination is recommended for optimal performance.

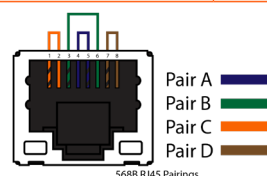

### Connection Instructions

1. Connect compatible HDBaseT transmitters (e.g. AT-OME-EX-TX) to the HDBaseT input ports.
2. Connect HDMI and USB-C sources to the HDMI and USB-C input ports.
3. \*Optional\* Connect 2CH sources to the analog AUDIO IN ports.
4. \*Optional\* Connect a MIC or line input to the MIC/LINE input port and use the dip switch to ensure the port is in the correct mode.
5. \*Optional\* Connect the 2CH analog AUDIO OUT ports to an audio DSP, amplifier, or other audio distribution devices.
6. \*Optional\* Connect USB devices (e.g. USB camera) to the USB hub ports.
7. \*Optional\* Connect the HOST USB port to a computer using a USB B to USB A cable (cable not provided).
8. \*Optional\* For control, connect to the 3-pin captive screw RS-232 port.
9. \*Optional\* Connect a network switch to the LAN port, for IP control or system configuration.
10. Connect an HDMI cable from the HDMI output port to a local display.
11. Connect a compatible HDBaseT Receiver (e.g. AT-OME-EX-RX or AT-OME-SR21) to the HDBaseT output port.
12. Connect the included IEC power cord from the power port to a compatible power outlet.

### IP Modes

#### DHCP

By default, the AT-OME-PS62 is set to DHCP mode. In this mode, when the AT-OME-PS62 is connected to the Local Area Network (LAN), it will automatically be assigned an IP address by the DHCP server (if available). Press the IP MODE button to show the IP address in the top left corner of the display connected to the HDMI output.

#### Static

If no DHCP server is available, or a static IP is required, the OME-PS62 can be set to static IP mode using the IP mode button.

- Press and hold the **IP MODE** button for 5 seconds to switch to static IP mode, the LED will blink 2 times when it goes into Static IP mode. In this mode, the AT-OME-PS62 will be set to the following:  
IP address: 192.168.1.254  
Subnet mask: 255.255.0.0  
Gateway: 192.168.1.1
- To switch back to DHCP, press and hold the IP mode button for 5 seconds. The LED will blink 4 times when successfully put into DHCP mode.

Connection Diagram

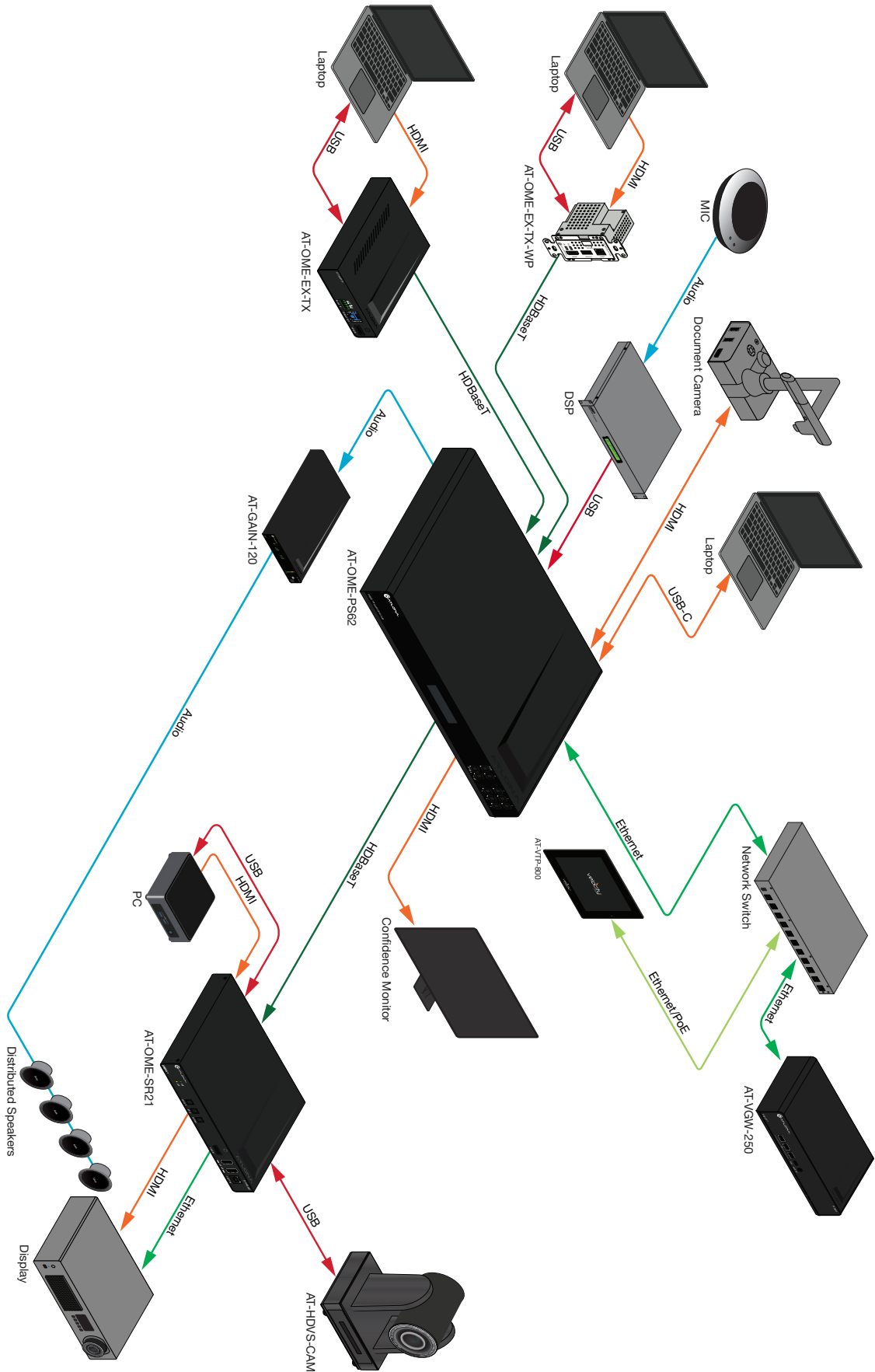

## Control

---

### CEC

CEC is available for trigger through RS-232, TCP/IP, and WebGUI (page 21). The trigger commands for RS-232 and TCP/IP can be found within the API at URL.

### RS-232

RS-232 control for connected devices and the unit are available through the RS-232 captive screw connection. The commands can be found within the API at [https://atlon.com/pdf/AT-OME-PS62\\_API.pdf](https://atlon.com/pdf/AT-OME-PS62_API.pdf).

### TCP Proxy

This unit has the ability to translate IP data to RS-232 through ports 9000+. This enables control of devices through TCP/IP that only have RS-232 ports. The unit will take the commands sent to port 9000, 9001, and 9002 and send them to the corresponding ports. More information and commands can be found within the API at URL.

### TCP/IP

TCP/IP control for connected devices and the unit are available through the LAN connection. The commands can be found within the API at URL.

### WebGUI

The unit has a built in web UI that will allow for unit configuration and device control. See the WebGUI section for more information.

# Front Panel Operation

The AT-OME-PS62 front panel provides a way to quickly view current settings, set up routing, load/save EDIDs, and save/recall current I/O routing. This will provide basic settings for use, view the webGUI section for more advanced set up and routing.

When turned on, the front panel will display initializing until the unit is fully powered and functional. After initial start up, the front panel will display the home screen.

**NOTE:** After 30 seconds of inactivity, the front panel LCD will turn off. Press any button to activate the LCD again.



For navigating through the front panel options and routing, the MENU, ENTER, up, down, and number keys will be used.

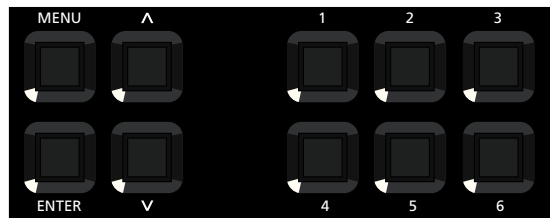

## Routing

### Basic

Basic routing can be done when the PS62 is in matrix mode.

1. Select the first input number and press enter. This will set the input for output 1.
2. Select the second input number and press enter. This will set the input for output 2.

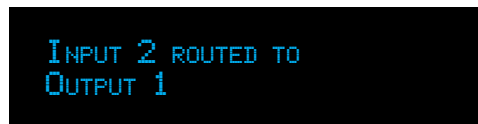
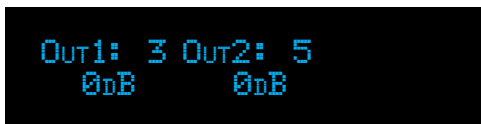

### ALL

All will route the selected input to all outputs.

1. Select the **MENU** button.
2. Use the **^** and **v** buttons to go through the menu options until the screen reads Route Setting.
3. Press Enter. The new screen should say Route All.
4. Press Enter again. The new screen will provide input options.
5. Select the input number to route to the outputs and press enter.

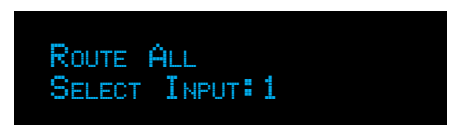
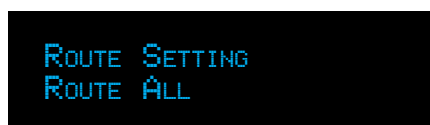
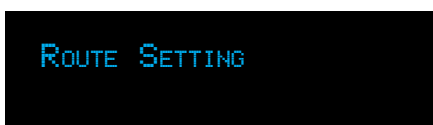

### Presets Save

Use the Save Preset option to place the current route in memory for later recall.

1. Select the **MENU** button.
2. Use the ^ and v buttons to go through the menu options until the screen reads Route Setting.
3. Press Enter.
4. Use the ^ and v buttons until the screen says Save Preset.
5. Press Enter again. The new screen will provide Memory number options to save to.
6. Select the memory number to save to and press enter.



```
ROUTE SETTING
```



```
ROUTE SETTING  
SAVE PRESET
```



```
SAVE PRESET  
SELECT MEMORY: 1
```

### Presets Recall

Use this option to recall the previously saved route preset.

1. Select the **MENU** button.
2. Use the ^ and v buttons to go through the menu options until the screen reads Route Setting.
3. Press Enter.
4. Use the ^ and v buttons until the screen says Recall Preset.
5. Press Enter again. The new screen will provide Memory number options to recall from.
6. Select the memory number to recall from and press enter.



```
ROUTE SETTING
```



```
ROUTE SETTING  
RECALL PRESET
```



```
RECALL PRESET  
SELECT MEMORY: 1
```

## Audio

### Route

Use this option to select the audio source that will be routed to the analog audio output.

1. Select the **MENU** button.
2. Use the **^** and **v** buttons to go through the menu options until the screen reads Audio Setting.
3. Press Enter. The new screen should say Audio Route.
4. Press Enter again. The new screen will provide output options.
5. Select the output number to route the audio source to and press enter.
6. Use the **^** and **v** buttons to scroll through the audio input options until the correct one is reached, then press enter.

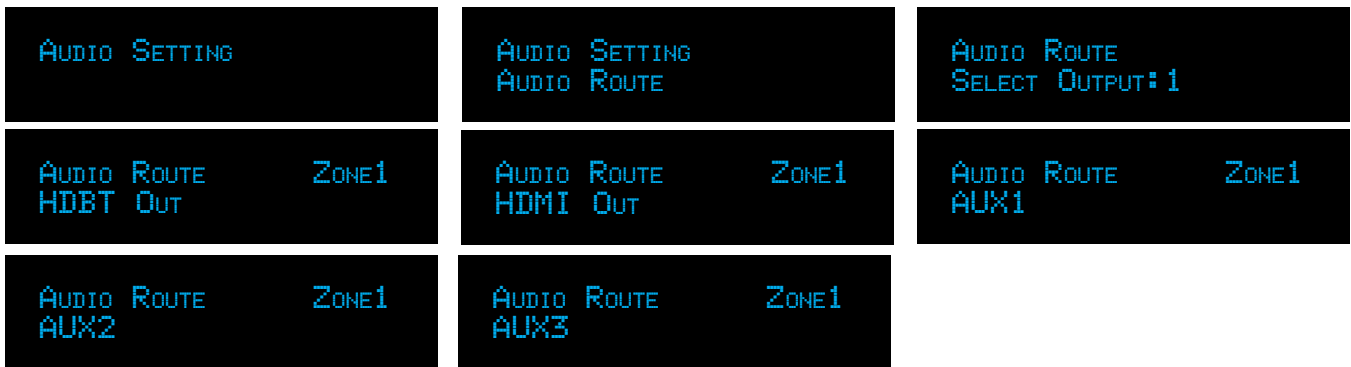

### Volume

Use this option to adjust the volume of the audio inputs.

1. Select the **MENU** button.
2. Use the **^** and **v** buttons to go through the menu options until the screen reads Audio Setting.
3. Press Enter.
4. Use the **^** and **v** buttons until the screen says Input Volume.
5. Press Enter again. The new screen will provide input options.
6. Use the **^** and **v** buttons to scroll through the inputs, then press Enter.
7. Use the **^** and **v** buttons to adjust the volume in dBs up and down.

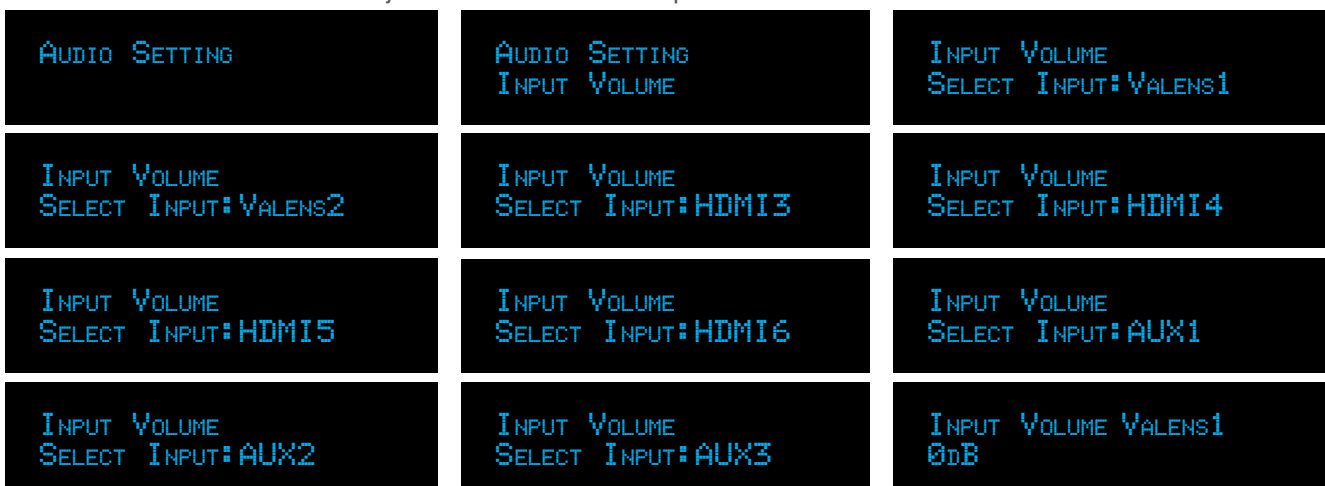



### EQ

Set the level of the EQ bands using these options.

1. Select the **MENU** button.
2. Use the **^** and **v** buttons to go through the menu options until the screen reads Audio Setting.
3. Press Enter.
4. Use the **^** and **v** buttons until the screen says EQ.
5. Press Enter again. The new screen will provide the EQ band options.
6. Use the **^** and **v** buttons to scroll through the bands, then press Enter.
7. Use the **^** and **v** buttons to adjust the level in dBs up and down.

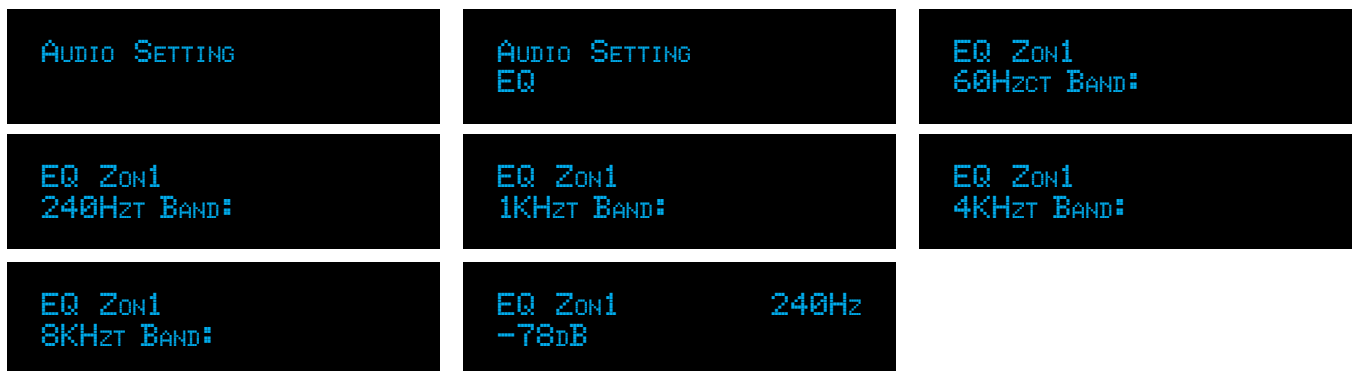

### MIC

Set whether the MIC will output on output one or two.

1. Select the **MENU** button.
2. Use the **^** and **v** buttons to go through the menu options until the screen reads Audio Setting.
3. Press Enter.
4. Use the **^** and **v** buttons until the screen says Mic Control.
5. Press Enter again. The new screen will provide output options.
6. Select the output number and press enter.
7. Use the **^** and **v** buttons to set the MIC routing on or off for the selected output.

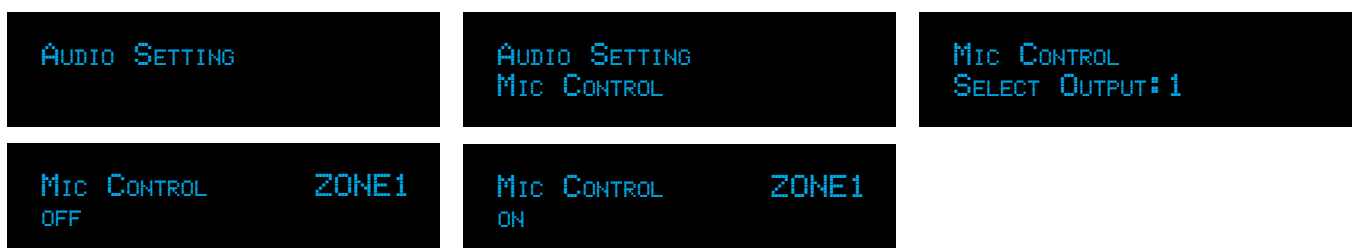

### MIC Ducking

Set the audio to adjust down when MIC input is detected.

1. Select the **MENU** button.
2. Use the **^** and **▼** buttons to go through the menu options until the screen reads Audio Setting.
3. Press Enter.
4. Use the **^** and **▼** buttons until the screen says Mic Ducking.
5. Press Enter again. The new screen will provide output options.
6. Select the output number and press enter.
7. Use the **^** and **▼** buttons to set the MIC ducking on or off for the selected output.

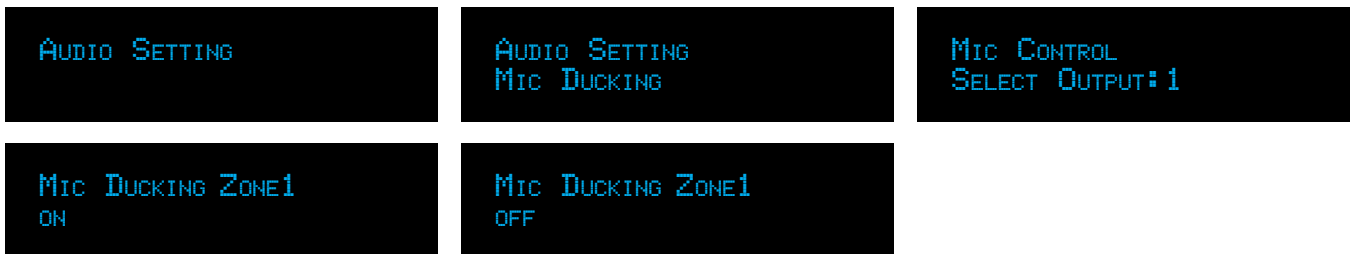

### EDID

EDIDs can be copied from the connected displays, assigned to inputs, or switched to one of the built in EDIDs to increase compatibility between devices.

### Copy

One output EDID can be saved to the device memory, this should be done before setting the EDID mode of the inputs.

1. Select the **MENU** button.
2. Use the **^** and **▼** buttons to go through the menu options until the screen reads EDID Setting.
3. Press Enter. The new screen should say EDID Mode.
4. Use the **^** and **▼** buttons until the screen says EDID Copy.
5. Select the output number to save that display's EDID to memory.

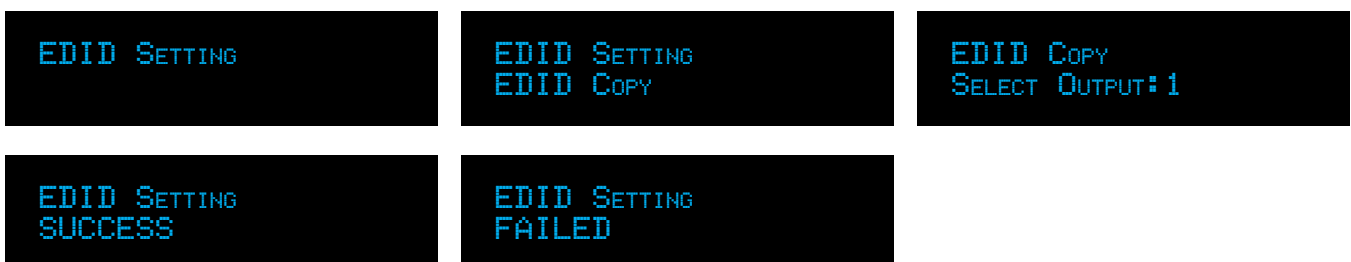

### Set EDID Mode

EDIDs mode for each unit can be set between Default (highest common resolution between the input and displays), the previously saved EDID, and Internal (6 choices of programmed EDIDs). All three options will use the same first 5 steps.

1. Select the **MENU** button.
2. Use the **^** and **v** buttons to go through the menu options until the screen reads EDID Setting.
3. Press Enter. The new screen should say EDID Mode.
4. Press Enter again. The new screen will provide input options.
5. Select the input number to set the EDID mode for and press Enter.



EDID SETTING



EDID SETTING  
EDID MODE



EDID MODE  
SELECT INPUT: 1

### Default

Once the input is selected, the mode can be set to default. Default is the highest common resolution between the input and the displays.

6. Select the 1 button and press enter. The input will now be set to Default EDID.



INPUT: 1 MODE: DEFAULT  
1: DEF 2: SAVED 3: INT

### Saved

Once the input is selected, the mode can be set to the previously saved EDID from the display.

6. Select the 2 button and press enter. The input will now be set to match the saved EDID.



INPUT: 1 MODE: DEFAULT  
1: DEF 2: SAVED 3: INT

### Internal

Once the input is selected, the mode can be set to internal, which will allow for selection between the 6 pre-programmed EDIDs listed in the table below.

Internal EDID #		Internal EDID #	
1	ATL 4K@2CH 444	4	ATL 1280x800
2	ATL 4K30 2CH	5	ATL 1920x1200
3	ATL 1080P 2CH	6	ATL 1366x768

6. Select the 3 button and press enter. This will bring up the first internal EDID.
7. Use the **^** and **v** buttons to go through the internal EDIDs.
8. Press Enter to set the internal EDID to the input.



INPUT: 1 MODE: DEFAULT  
1: DEF 2: SAVED 3: INT



INPUT: 1 MODE: INT  
ATL4K@2CH444

### Info

The Info function will display basic information for the unit: unit firmware, Valens firmware, IP mode, IP address, IP port, SSH port, MAC address, and unit baud rate.

1. Select the **MENU** button.
2. Use the **^** and **▼** buttons to go through the menu options until the screen reads Info.
3. Press Enter. The new screen should give the unit firmware info.
4. Use the **^** and **▼** buttons to scroll through the different information.

INFO	AT-OME-PS62 FW VER: 1.2.0	VALENS FW 7.4.16
IP MODE DHCP	IP ADDRESS: 192.168.0.2	IP PORT: 23
SSH PORT: 22	MAC ADDRESS: B8:98:B0:XX:XX:XX	CONSOLE BAUD RATE 115200

## WebGUI

The AT-OME-PS62 includes a built-in webGUI, which allows easy remote management and control of all features. Follow the instructions below to access the webGUI.

1. Make sure that an Ethernet cable is connected between the **LAN** port on the AT-OME-PS62 and the network.
2. Use an IP scanner to determine the IP address of the unit.
3. Launch a web browser and enter the IP address in the address bar.
4. The AT-OME-PS62 **Register** page will be displayed, create a Username and Password.
5. Write down the Username and Password, if lost the unit will need to be factory reset to gain access.

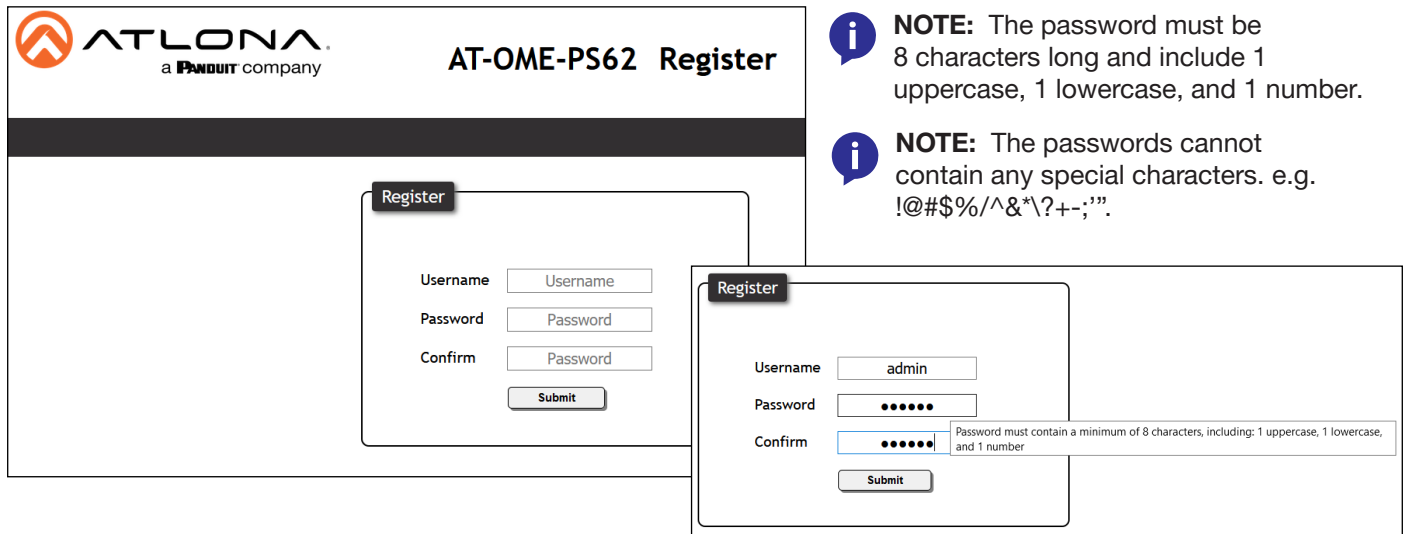

**NOTE:** The password must be 8 characters long and include 1 uppercase, 1 lowercase, and 1 number.

**NOTE:** The passwords cannot contain any special characters. e.g. !@#\$/%^&\*?+-;'.

6. Click the **Submit** button. The info page will display, giving all the general information of the AT-OME-PS62.

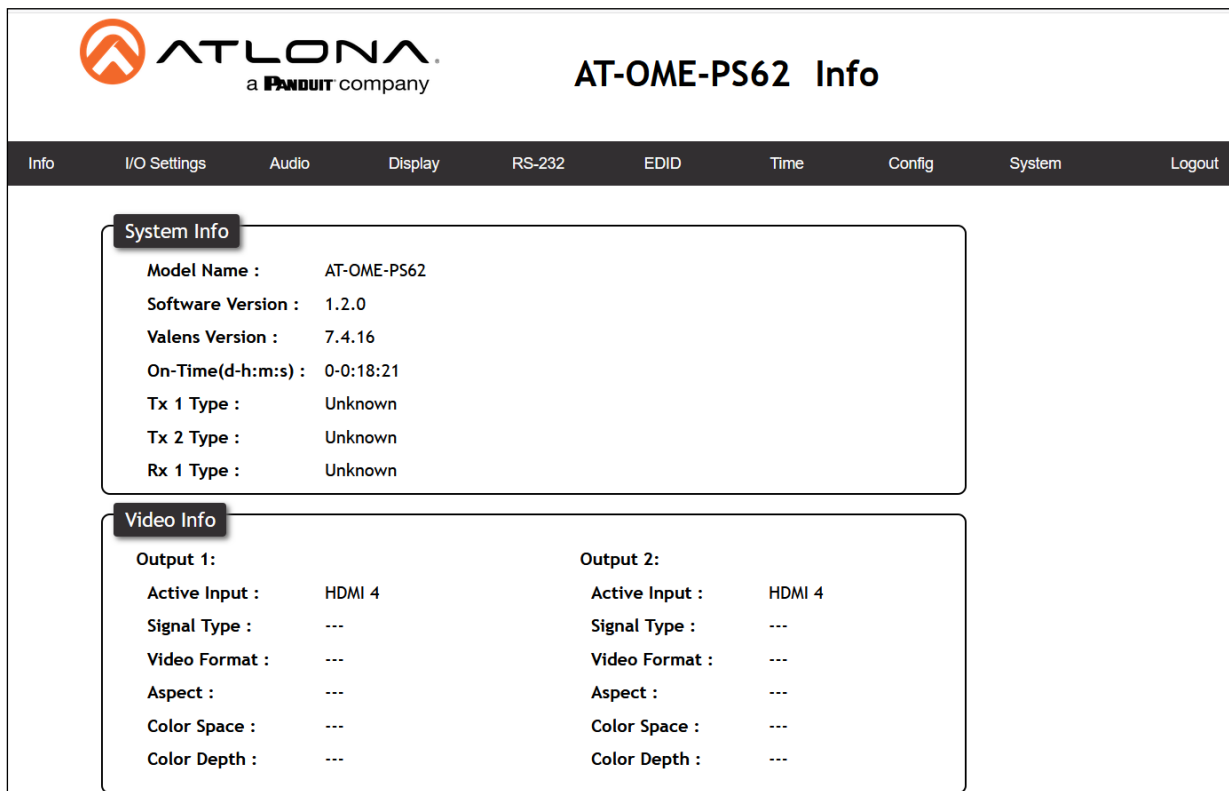

**System Info**

Model Name :	AT-OME-PS62
Software Version :	1.2.0
Valens Version :	7.4.16
On-Time(d-h:m:s) :	0-0:18:21
Tx 1 Type :	Unknown
Tx 2 Type :	Unknown
Rx 1 Type :	Unknown

**Video Info**

<b>Output 1:</b>		<b>Output 2:</b>	
Active Input :	HDMI 4	Active Input :	HDMI 4
Signal Type :	---	Signal Type :	---
Video Format :	---	Video Format :	---
Aspect :	---	Aspect :	---
Color Space :	---	Color Space :	---
Color Depth :	---	Color Depth :	---

## I/O Settings

Select I/O Settings from the top navigation to adjust routing and video settings.

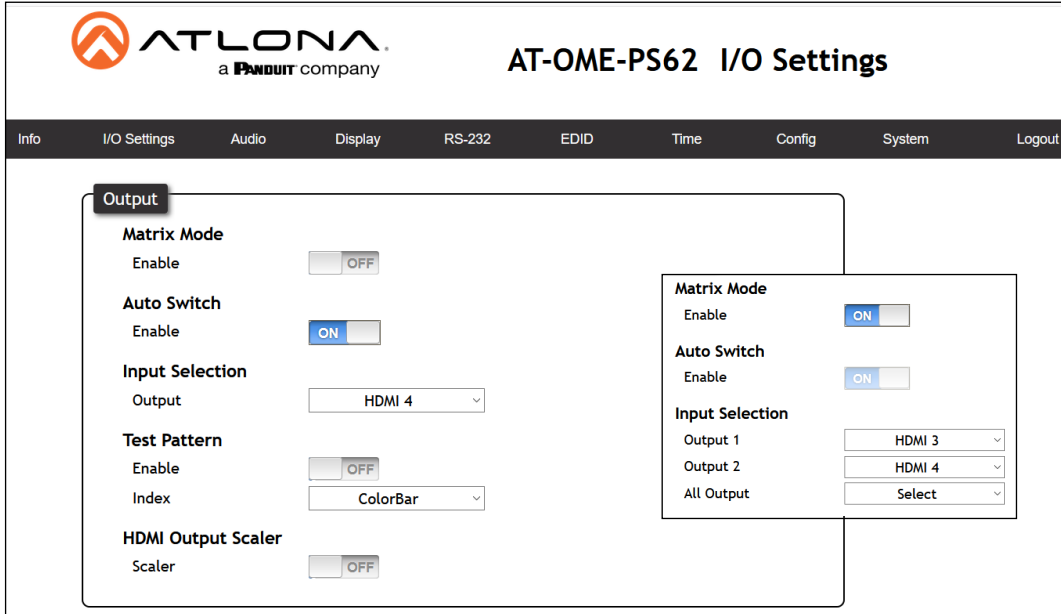

### Output

**Matrix Mode** - When enabled, the outputs will switch independently. When disabled (default), the outputs will mirror each other.

**Auto Switch** - When enabled, the input will switch to the most recently plugged in. This is only available when Matrix mode is disabled.

**Input Selection** - Manually route ports. Only one port will be switchable when matrix mode is disabled. When matrix mode is enabled, it will have the option to switch both ports independently or use the all output selection to select the same source for both outputs.

**Test Pattern** - Disabled by default. When enabled, output 1 will display one of the three test pattern options: ColorBar, CrossHatch, and Slash.

**HDMI Output Scaler** - By default, the scaler is disabled. When enabled, new options will appear.

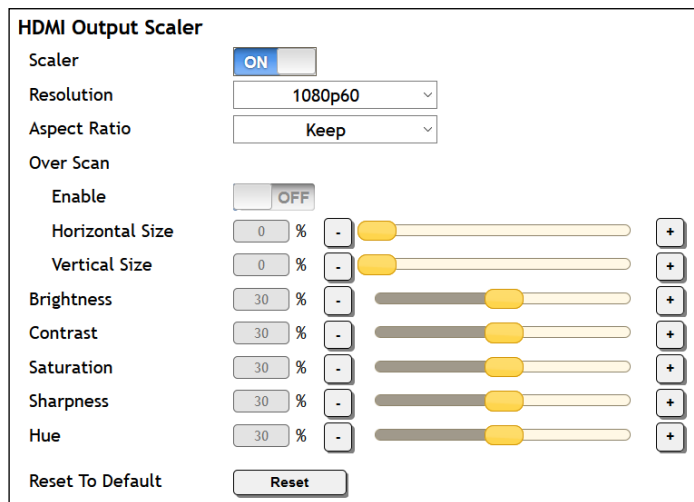

### HDMI Output Scaler

Scaler - When enabled, will display extra options. This is for the HDMI output only.

Resolution - Select the output resolution the source signal will be scaled to from the drop down menu.

Scaling options: 1024x768, 1280x768, 1280x800, 1360x768, 1600x1200, 1920x1200, 2048x1080, 1280x720p50, 1280x720p60, 1920x1080p24, 1920x1080p25, 1920x1080p50, 1920x1080p60 (default), 3840x2160p24, 3840x2160p25, 3840x2160p30, 3840x2160p50, 3840x2160p60, 4096x2160p24, 4096x2160p25, 4096x2160p30, 4096x2160p50, 4096x2160p60

**NOTE:** Based on the selection from the drop down menu, the scaler will adjust not only resolution but frame rate as well. All VESA resolutions will output at 60Hz when using the scaler.

Aspect Ratio - Select between Keep (which will keep the aspect ration of the source device) and Fill (which will adjust the picture to fill the display).

Overscan - Enable to be able to manually adjust the horizontal and vertical size of the source image. Default is 0 and can be adjust from 0% to 50%.

Brightness, Contrast, Saturation, Sharpness, Hue - Adjust the output's brightness, contrast, saturation, sharpness, and hue manually. Default is 0% and can be adjusted from 0% to 60%.

Reset To Default - Press the Reset button to set all the scaling options back to factory defaults.

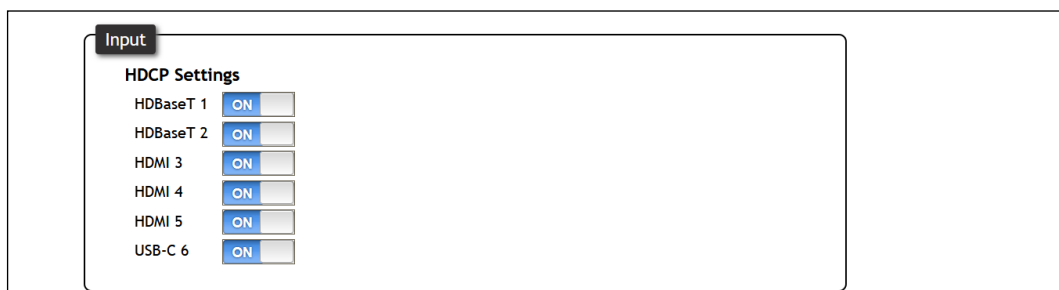

### Input

HDCP - On - This mode is selected by default. The PS62 will report HDCP compliant to the selected sources. If the outputs are not HDCP compliant, they will receive no signal from the source.

HDCP - Off - When selected, the PS62 will report non-HDCP to the source, so it will only send non compliant source signals. This is especially good for presentation that are using sources that automatically report all signals as HDCP compliant even when no HDCP is necessary (e.g. apple computers with spreadsheets and other non compliant presentation material).

## Audio

Select Audio from the top navigation to adjust output levels and MIC options.

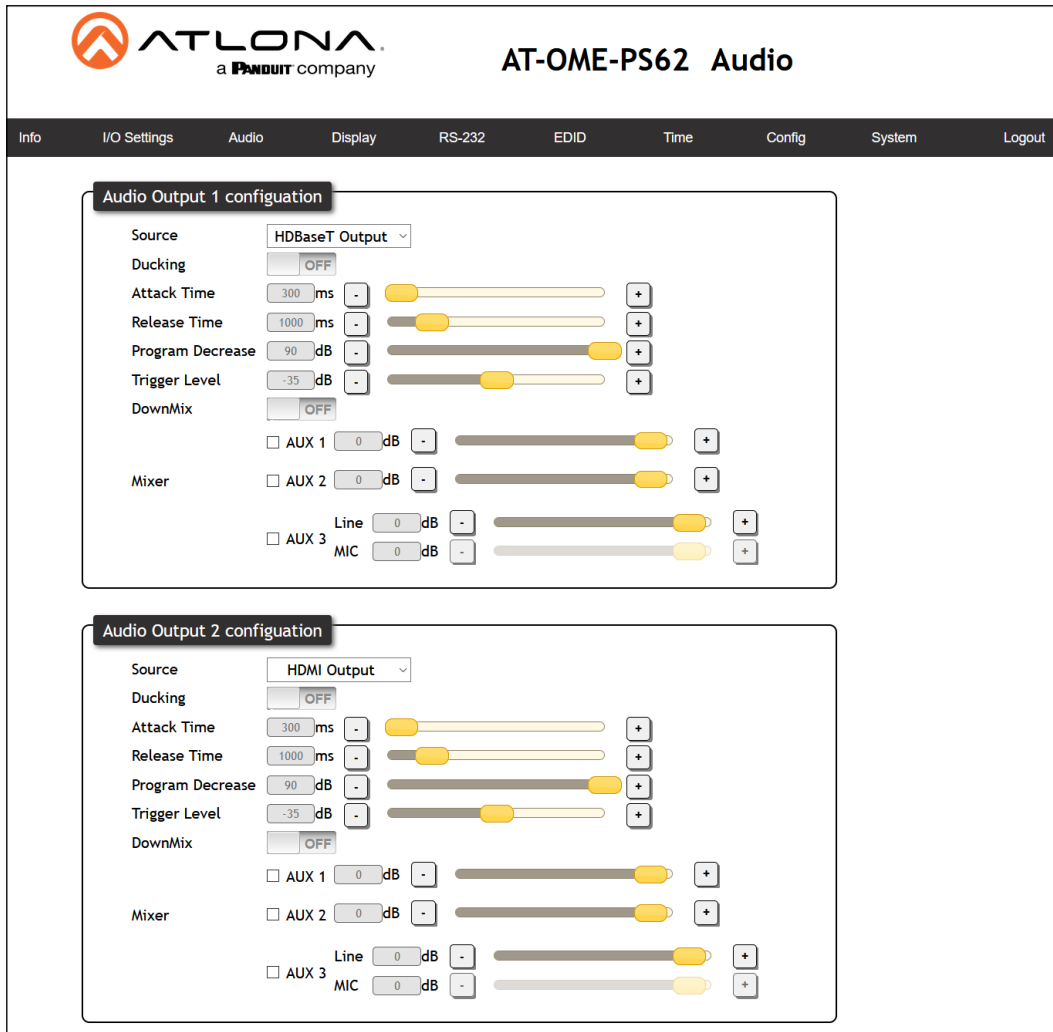

### Audio Output 1 & 2 configuration

Source - Select between HDMI Output, HDBaseT Output, Aux 1 (AUDIO IN 1), Aux 2 (AUDIO IN 2), and Aux 3 (LINE IN) to.

Ducking - Enable ducking to have the source audio adjust when receiving active MIC input.

Attack Time - Set the delay before ducking begins after detecting signal from a microphone.

Release Time - Sets the delay time after no signal is detected that ducking stops.

Program Decrease - Set the amount to ensure the program level is low enough when ducking is triggered that the speaker/audio is heard.

Trigger Level - Set the level of sound from the MIC that will trigger ducking.

DownMix - Sets AUX source to mix output mono (enabled) or two channel (disabled).

Mixer - Mix analog audio sources in with program audio.



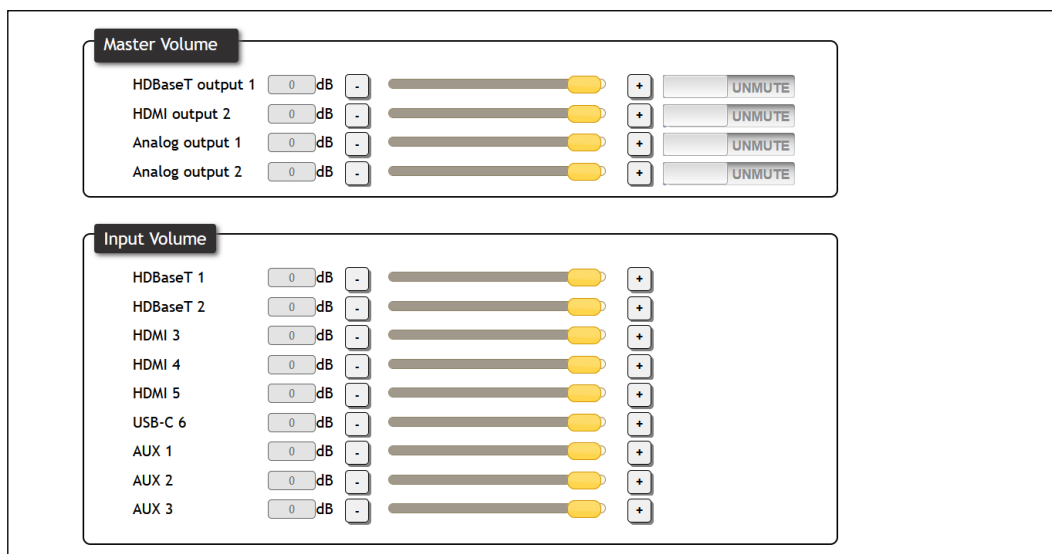

### Master Volume

Output 1 & 2 - Adjusts the output volume for the HDMI and HDBaseT outputs. Default is 0dB and can be adjusted from -90dB to 10dB.

Mute - Use the slider to mute and unmute the output audio.

### Input Volume

Level Adjustment - Adjusts the input volume for each individual audio source. Default is 0dB and can be adjusted from -90dB to 10dB.

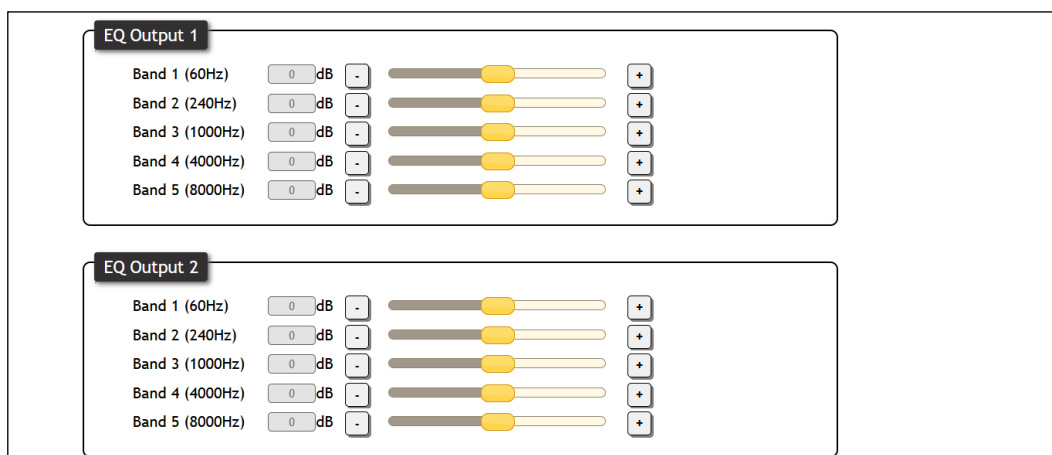

### EQ Output 1 & 2

Band level - Use the slider to adjust each individual band of the output volume. Default is 0dB and can be adjusted from -12dB to 12dB.

## Display

Select Display from the top navigation to adjust display control settings.

**NOTE:** The Display page is only available when Matrix mode is disabled.

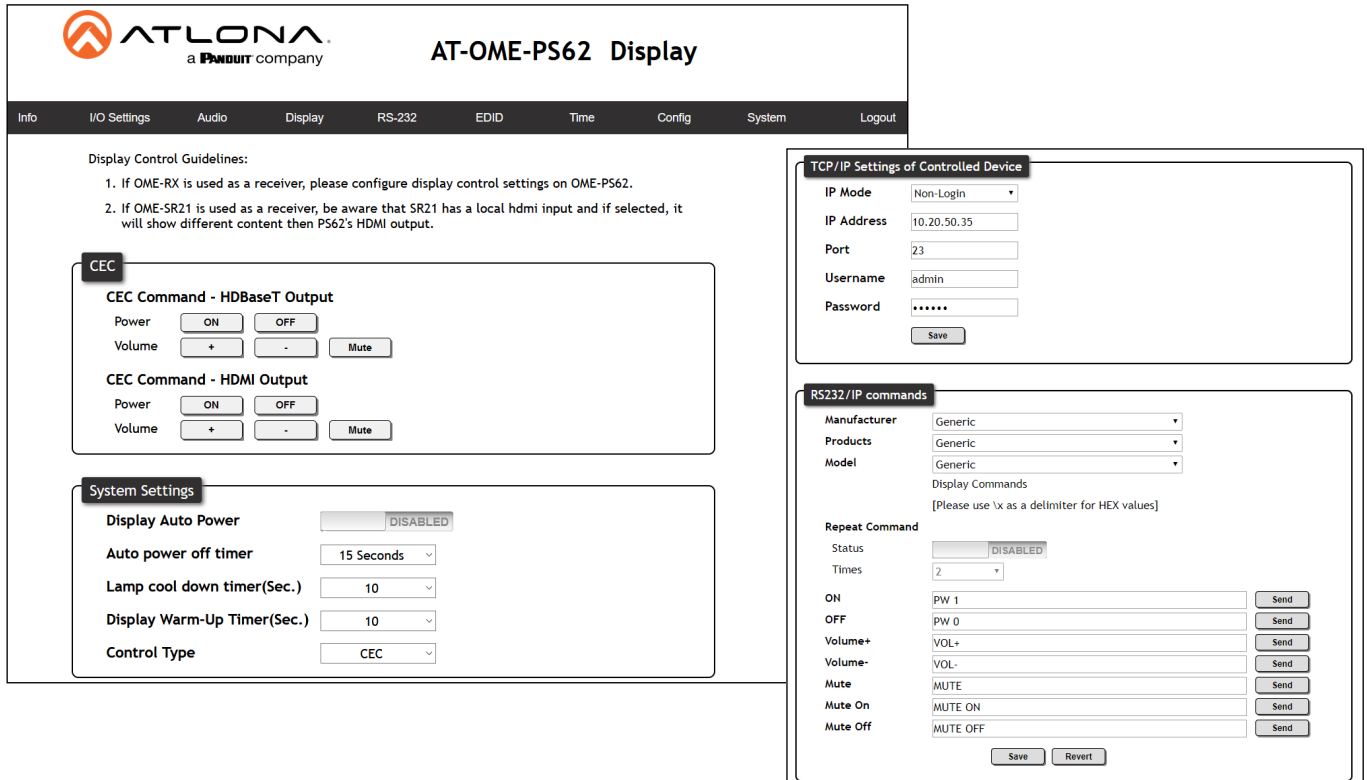

**Display Control Guidelines:**

1. If OME-RX is used as a receiver, please configure display control settings on OME-PS62.
2. If OME-SR21 is used as a receiver, be aware that SR21 has a local hdmi input and if selected, it will show different content then PS62's HDMI output.

**CEC**

**CEC Command - HDBaseT Output**

Power

Volume

**CEC Command - HDMI Output**

Power

Volume

**System Settings**

Display Auto Power

Auto power off timer

Lamp cool down timer(Sec.)

Display Warm-Up Timer(Sec.)

Control Type

**TCP/IP Settings of Controlled Device**

IP Mode

IP Address

Port

Username

Password

**RS232/IP commands**

Manufacturer

Products

Model

Display Commands  
[Please use '\x' as a delimiter for HEX values]

Repeat Command

Status

Times

ON

OFF

Volume+

Volume-

Mute

Mute On

Mute Off

### CEC Command HDBaseT and HDMI

**Power** - Using CEC protocol, the PS62 will send the on and off commands out the HDMI outputs of the PS62 and compatible HDBaseT receiver.

**Volume** - Pressing these buttons will send the CEC commands for volume up, down, and mute, out the HDMI outputs of the PS62 and compatible HDBaseT receiver.

### System Settings

**Display Auto Power** - Enable to send the programmed command to the display to turn on or off when detecting or losing A/V signals.

**Auto power off timer** - Sets the period of time between the loss of A/V signal and when the display off command is sent. Default is 15 seconds and can be adjusted from 5 seconds to 1 hour.

**Lamp cool down timer (Sec.)** - Sets the time between when projector lamp has been turned off to when it can receive new commands. Default is 10 seconds and can be adjusted from 10 seconds to 300 seconds.

**Display Warm-Up Timer (Sec.)** - Sets the time between when the projector lamp has been turned on to when it can receive new commands. Default is 10 seconds and can be adjusted from 10 seconds to 300 seconds.

**Control Type** - By default, CEC is selected for control of the display. IP and RS-232 can also be selected. When IP or RS-232 are selected, more fields are available.

**TCP/IP Settings of Controlled Device**

**IP Mode**

**IP Address**

**Port**

**Username**

**Password**

### TCP/IP Settings of Controlled Device (only available when IP is selected)

**IP Mode** - Toggle telnet login mode between Non-Login and Login. If set to Login, a username and password will be required to control the controlled device via TCP/IP.

**IP Address** - Sets to the IP of the controlled device/display.

**Telnet Port** - Set the telnet port of the controlled device for control. Default is 23.

**Username & Password** - Sets the username and password that is required when login mode is enabled.

**RS232/IP commands**

**Manufacturer**

**Products**

**Model**

Display Commands  
 [Please use \x as a delimiter for HEX values]

**Repeat Command**

Status  DISABLED

Times

**ON**

**OFF**

**Volume+**

**Volume-**

**Mute**

**Mute On**

**Mute Off**

**RS232/IP commands**

**Manufacturer**

**Products**

**Model**

**Repeat Command**

Status  DISABLED

Times

**ON**

**OFF**

**Volume+**

**Volume-**

**Mute**

**Mute On**

**Mute Off**

**RS232/IP commands**

**Manufacturer**

**Products**

**Model**

Display Commands  
 [Please use \x as a delimiter for HEX values]

### RS-232 / IP Commands

**Manufacturer, Products, Models** - Select the make and model of the display for control. Commands have been programmed into the PS62 for a wide range of products. If the current display is not found within the database, use generic and manually adjust the command fields.

**Repeat Command** - Enable Status to repeat the commands. Default repeat number is 2 and can be adjusted from 2 to 4 times.

**Commands: On/Off/Volume/Mute** - These fields will automatically be filled with the correct command when selecting a manufacturer and product from the drop down menus. If manually entering the commands, type them into the fields next to the command name.

**Send** - Use this button to send the command to the display, this can be used while manually typing the commands to ensure the commands are correct.

**Save** - Save the commands to the webGUI. Manufacturer, products, and Model will revert to Generic but the commands will be saved from the previously selected and saved Manufacturer, products, and model selection.

**Revert** - Sets the commands back to the previously saved settings.

## RS-232

Select RS-232 from the top navigation to adjust the parameters of the RS-232 ports.

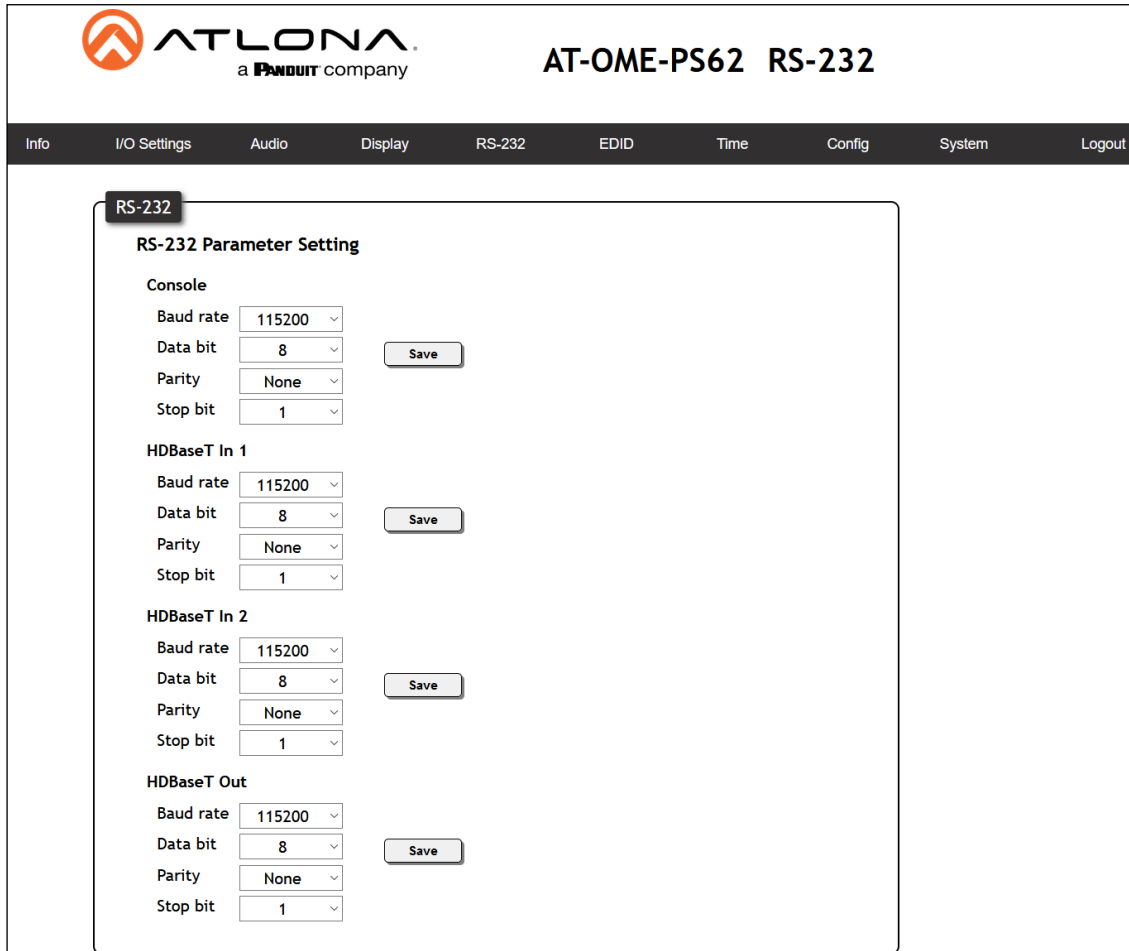



**AT-OME-PS62 RS-232**

Info
I/O Settings
Audio
Display
RS-232
EDID
Time
Config
System
Logout

RS-232

**RS-232 Parameter Setting**

**Console**

Baud rate:

Data bit:

Parity:

Stop bit:

**HDBaseT In 1**

Baud rate:

Data bit:

Parity:

Stop bit:

**HDBaseT In 2**

Baud rate:

Data bit:

Parity:

Stop bit:

**HDBaseT Out**

Baud rate:

Data bit:

Parity:

Stop bit:

### RS-232 Parameter Setting

Console - Select the baud rate, data bit, parity, and stop bit to match the control system's parameters. Defaults are 115200, 8, None, and 1.

HDBaseT In 1 - Select the baud rate, data bit, parity, and stop bit that will be sent from the HDBaseT IN port to the connected HDBaseT transmitter. This should be set to match the source device being controlled by the transmitter. Defaults are 115200, 8, None, and 1.

HDBaseT In 2 - Select the baud rate, data bit, parity, and stop bit that will be sent from the HDBaseT IN port to the connected HDBaseT transmitter. This should be set to match the source device being controlled by the transmitter. Defaults are 115200, 8, None, and 1.

HDBaseT Out - Select the baud rate, data bit, parity, and stop bit that will be sent from the HDBaseT OUT port to the connected HDBaseT receiver. This should be set to match the source device being controlled by the receiver. Defaults are 115200, 8, None, and 1.

## EDID

Select EDID from the top navigation to save/load EDIDs.

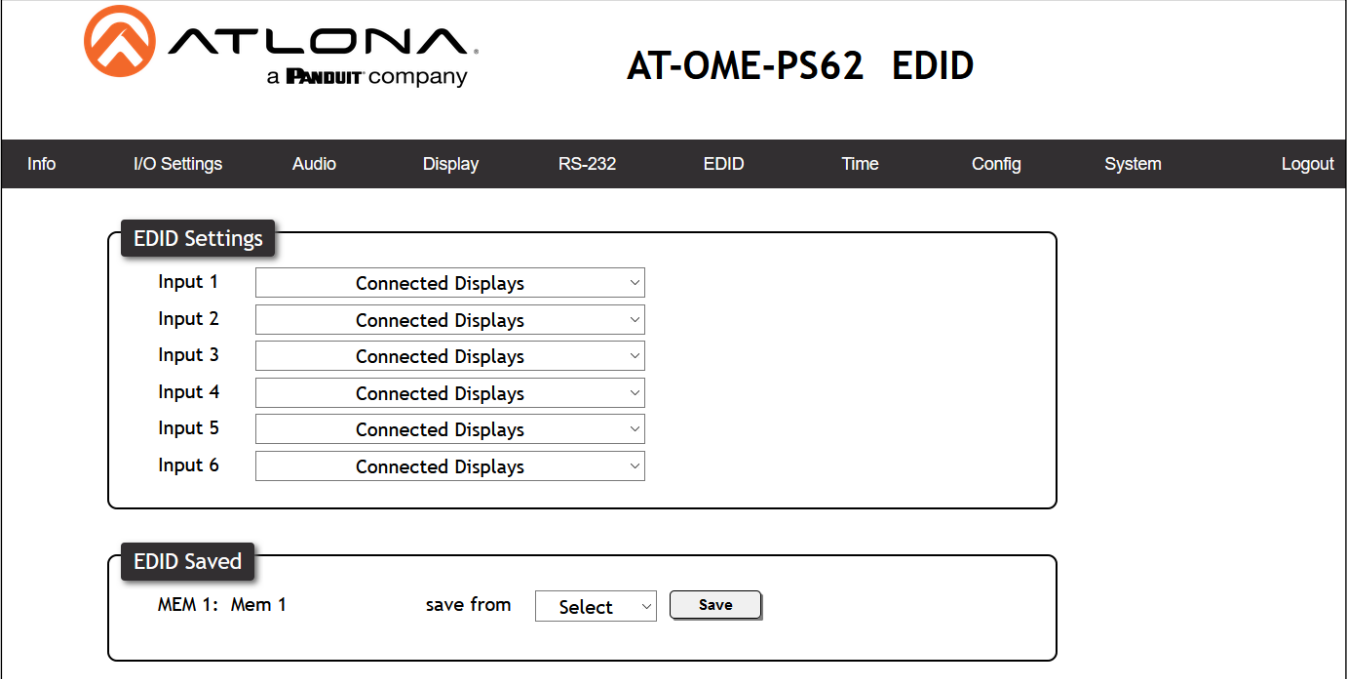

**ATLONA**  
a **PANDUIT** company

### AT-OME-PS62 EDID

Info I/O Settings Audio Display RS-232 EDID Time Config System Logout

**EDID Settings**

Input 1	Connected Displays	▼
Input 2	Connected Displays	▼
Input 3	Connected Displays	▼
Input 4	Connected Displays	▼
Input 5	Connected Displays	▼
Input 6	Connected Displays	▼

**EDID Saved**

MEM 1: Mem 1      save from      Select ▼      Save

## EDID

EDID Settings - Use the drop down menu to select from default (highest common resolution between source and display), 12 internal EDIDs, and previously saved EDIDs.

EDID Saved - The ID field will display the memory # and currently saved EDID name, select the output from the drop down menu to be saved. Once the output is selected, press the save button to make it available in the EDID settings drop down menus.

## Time

Select Time from the top navigation to select the time server for the unit to sync to.



### AT-OME-PS62 Time

Info
I/O Settings
Audio
Display
RS-232
EDID
Time
Config
System
Logout

Time

#### SNTP Configuration

GMT

NTP Server

Server Time

#### Daylight Saving Time Configuration

Start Time     :

End Time     :

Adjust Time  :

### SNTP Configuration

Server info - Select the time zone the unit will run in. If the unit has internet access, it can be set to sync to a server as well. Press the Sync button if using a server time or press the Save button if setting by timezone.

### Daylight Savings Time Configuration

Enable/Disable slider - Default is disabled. Enable to have the unit automatically update with Daylight savings time.

Daylight Savings settings - Set the date and time to have the unit start and end Daylight Savings time and how much time the unit will adjust by.

## Config

Select Config from the top navigation to change the user password.

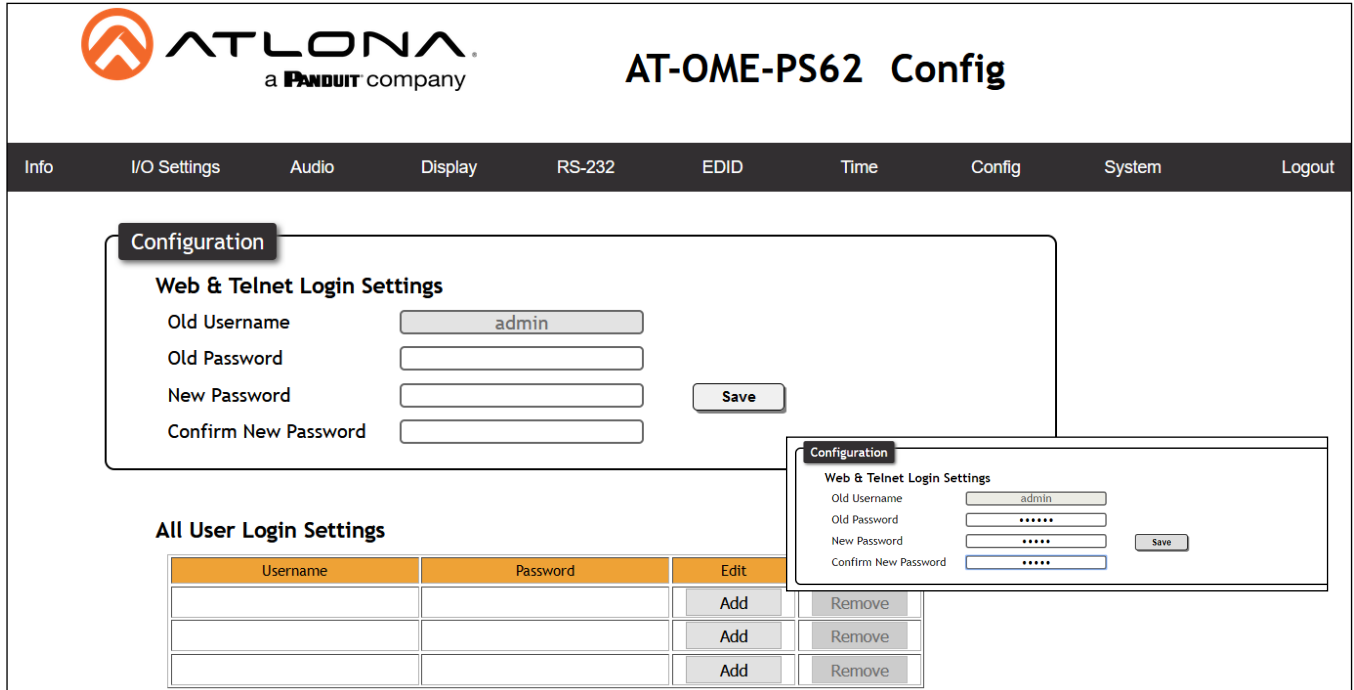

The screenshot shows the AT-OME-PS62 Config page. The top navigation bar includes: Info, I/O Settings, Audio, Display, RS-232, EDID, Time, Config, System, and Logout. The main content area is titled "Configuration" and contains two sections:

- Web & Telnet Login Settings:** Includes input fields for Old Username (admin), Old Password, New Password, and Confirm New Password, along with a Save button.
- All User Login Settings:** A table with columns for Username, Password, and Edit. The Edit column contains "Add" and "Remove" buttons for each row.

### Web & Tel

Password - Update the main password for the switcher. Only the main password may be changed, the username will remain what it was set to in the initial log in/registration.

- NOTE:** The password must be 8 characters long and include 1 uppercase, 1 lowercase, and 1 number.
- NOTE:** The passwords cannot contain any special characters. e.g. !@#\$%^/&\*?+-;”.

Once the new password has been entered, press the Save button to make the password live. The user will be logged out and must log back in with the new password.

### All User Login Settings

Add - Select the **Add** button, a new screen will open. Enter a username and password, then select Submit. Up to three users can be added, these users will not have the ability to see other other usernames and passwords.

Remove - Select the **Remove** button to delete the username and password. A new pop up will appear, select OK to confirm the removal of the usernames and passwords.

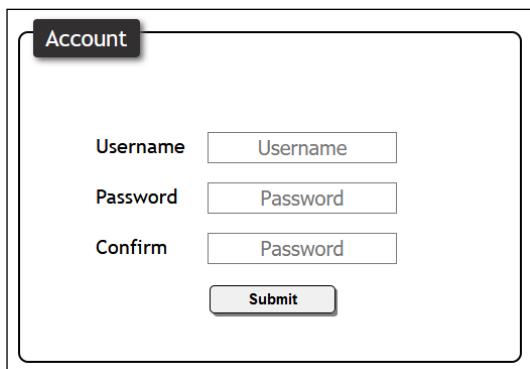

The Account form includes input fields for Username, Password, and Confirm, along with a Submit button.

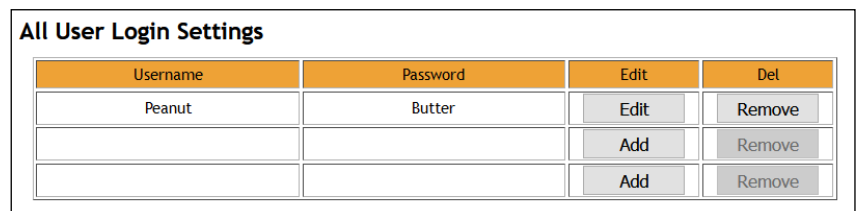

Username	Password	Edit	Del
Peanut	Butter	Edit	Remove
		Add	Remove
		Add	Remove

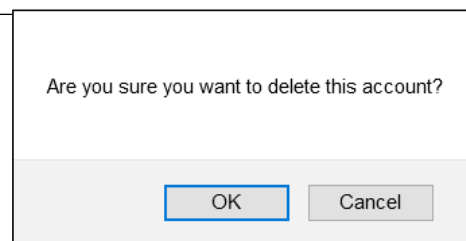

Are you sure you want to delete this account?

OK Cancel

## System

Select System from the top navigation to adjust network, USB, and general system options.

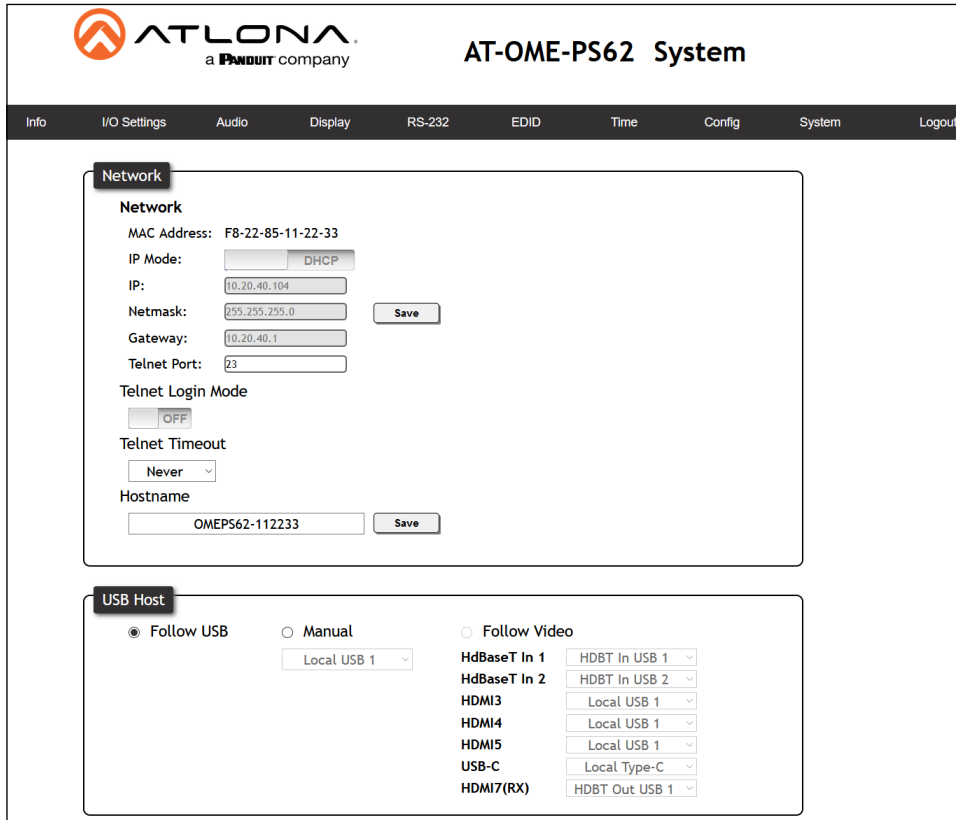

The screenshot shows the AT-OME-PS62 System webGUI. The top navigation bar includes: Info, I/O Settings, Audio, Display, RS-232, EDID, Time, Config, System, and Logout. The main content area is divided into two sections:

- Network:**
  - MAC Address: F8-22-85-11-22-33
  - IP Mode:  Static  DHCP
  - IP:
  - Netmask:
  - Gateway:
  - Telnet Port:
  - Telnet Login Mode:  ON  OFF
  - Telnet Timeout:
  - Hostname:
- USB Host:**
  - Follow USB
  - Manual
  - Follow Video
  - HdBaseT In 1:
  - HdBaseT In 2:
  - HDMI3:
  - HDMI4:
  - HDMI5:
  - USB-C:
  - HDMI7(RX):

### Network

MAC Address - Displays the MAC address of the unit.

IP Mode - Switch between static and DHCP IP modes.

IP, Netmask, Gateway - This will display the unit's current DHCP IP settings. When set to static, fill in the IP address, netmask, and gateway.

Telnet Port - Set the telnet port if needed for control. Default port is 23.

Telnet Login Mode - Toggle telnet login mode on and off. If on, a username and password will be required to control the unit via telnet.

Telnet Timeout - Set the amount of time between actions before the current user is logged out. Default is 10000 seconds.

Hostname - Set the name for the matrix, this will show up in network discovery.

### USB Host

Follow USB - Sets the USB hosts to follow the most recently connected device. If a host is connected, then it will auto switch to that source. If the current host loses signal or stops broadcasting, it will fall back to the previously connected active device.

Manual - Select which host will be used. Select between local USB Hosts, USB-C, and compatible connected HdBaseT devices.

Follow Video - Sets the USB hosts to follow the input selection. If an input on the transmitter is selected, the USB will switch to the transmitter's host ports, if a source on the switcher is selected, it will switch to the PS62's host port.



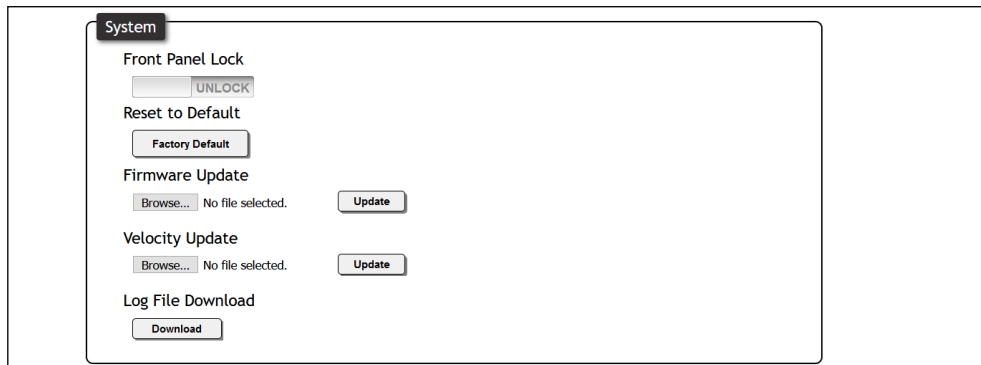

## System

Front Panel Lock - Lock or unlock the front panel buttons.

Reset to Default- Press the Factory Default button to set the unit back to all factory settings, including IP mode.

Firmware update - Use the choose file button to search the local PC for the firmware file. Once selected, press the update button to start the firmware update.

 **NOTE:** Firmware updates and release notes can be found at <https://atlona.com/product/AT-OME-PS62/> .

Velocity Update- For future update to the commands database, when separate from the main firmware.

Log File Download - Select the download button to download the bug log for troubleshooting.

# Appendix

## Specifications

Video	
HDMI	2.0 (1.4 when downscaled)
HDCP	2.2 / 1.4
UHD/HD/SD	4096x2160@60 <sup>(1)</sup> /50/30/25/24Hz, 3840x2160@60 <sup>(1)</sup> /50/30/25/24Hz, 1080p@60/59.9/50/30/29.97/25/24/23.98Hz, 1080i@30/29.97/25Hz, 720p@60/59.94/50Hz, 576p@50Hz, 576i@25Hz, 480p@60/59.96Hz, 480i@30Hz
VESA	2560x1600, 2048x1536, 1920x1200, 1680x1050, 1600x1200, 1440x900, 1400x1050, 1280x1024, 1280x800, 1366x768, 1360x768, 1152x864, 1024x768, 800x600, 640x480
USB-C	Up to 4K/UHD @ 60Hz
Color Space	YUV, RGB
Chroma Subsampling	4:4:4, 4:2:2, 4:2:0
Color Depth	8-bit, 10-bit, 12-bit
HDR	HDR10, Hybrid-Log Gamma (HLG), and Dolby® Vision™ @ 60Hz; HDMI and USB-C ports only

Audio	
HDMI / HDBaseT Pass-Through Formats	PCM 2.0, LPCM 5.1, LPCM 7.1, Dolby® Digital, Dolby Digital Plus™, Dolby TrueHD, Dolby Atmos®, DTS® Digital Surround™, DTS-HD Master Audio™, and DTS:X®
Bit Depth	24 bits
<b>Analog Audio</b>	
Format	Stereo 2-Channel
Balanced Output	+4 dBu nominal gain, +20 dB headroom
Frequency Response	20 Hz to 20 kHz, ± 0.5 dB
Impedance	150 Ω
Stereo channel separation	> 90 dB
THD+N	< 0.004% at 20 Hz to 20 kHz
SNR	> 103.7 dB at 1 kHz, zero clipping @ 0 dBFS, unweighted
EQ	5 band, 63Hz, 85Hz, 250Hz, 1kHz, 4kHz
<b>MIC</b>	
Phantom Power	48V, enable and disable through webGUI / 3-pin MIC option
Ducking	Selectable on/off
Trigger level	Selectable, -60 to -10 dB
Attack Time	Selectable, 1 to 5000 ms
Release Time	Selectable, 1 to 5000 ms
Sample Rate	32 kHz, 44.1 kHz, 48 kHz, 88.2 kHz, 96 kHz, 176.4 kHz, 192 kHz

USB	
Compliance	2.0
Maximum Data Rate	120 Mbps
USB-C	Supports Audio, Video, and device & host data
Internal Hubs	1 USB hub when connected to USB type B host port, 2 cascaded USB hubs when connected to USB-C port

Control	
RS-232	Device control and configuration Bidirectional pass-through from control system over HDBaseT Supported baud rates: 2400, 4800, 9600, 19200, 38400, 57600, 115200
IP	Protocols: Https, Telnet, mDNS Modes: DHCP, Static - selectable through front panel and webGUI
CEC Support	Yes

Resolution / Distance	4K/UHD - Feet / Meters		1080p - Feet / Meters	
HDMI IN/OUT	15	5	30	10
CAT5e	295	90	330	100
CAT6/6a/7	330	100	330	100

Connectors, Controls, and Indicators	
HDMI IN	3 - Type A, 19-pin female
HDBaseT IN	2 - RJ45, female
USB-C IN	1 - USB Type-C v3.1, 24-pin female, AV input (Alternate Mode)
HDMI OUT	1 - Type A, 19-pin female
HDBaseT OUT <sup>(2)</sup>	1 - RJ45, female
USB HUB	2 - Type A, 4-pin female
USB HOST	2 - Type B, female
LINE/MIC IN	1 - 6-pin captive screw, balanced / unbalanced line level input w/3-pin MIC option
LINE/MIC Switch	1 - 3 position switch - MIC, 48V, and LINE
AUDIO IN	2 - 5-pin captive screw, balanced / unbalanced 2-channel
AUDIO OUT	2 - 5-pin captive screw, balanced / unbalanced 2-channel
RS-232	2 - 3-pin captive screw (bidirectional)
LAN	2 - RJ45, 100Base-T
PWR	1 - Internal 100-240 VAC 50/60Hz, IEC female connector
<b>Control Buttons:</b> MENU, NAV, and NUMBER IP MODE and RESET	10 - momentary, tact-type 2 - momentary, recessed
<b>Function Indicators:</b> IP MODE, RESET	2 - LED, green

Temperature	Fahrenheit	Celsius
Operating	32 to 122	0 to 50
Storage	-4 to 140	-20 to 60
Humidity (RH)	20% to 60%, non-condensing	

Power	
Consumption	<b>Unit only:</b> 58W <b>Full load:</b> 170W (while powering USB-C device up to 60W, HDBaseT PoE devices up to 15W each, and USB type A devices up to 2.5W each)
Supply	100-240 VAC, 50/60Hz

Dimensions	Inches	Millimeters
H x W x D	1.73 x 17.24 x 10	44 x 438 x 254

Weight	Pounds	Kilograms
Device	7.76	3.52

Certification	
Device	CE, FCC, UL

(1) 4K/UHD @ 60 Hz only supports 4:2:0.

(2) Maximum limit of 6 USB hubs when traversing an HDBaseT link.

