

4K / HDR

HDMI to HDBaseT™ 1 x 2 Distribution Amplifier



Version Information

Version	Release Date	Notes
6	Jan 2024	Updated warranty information

Sales, Marketing, and Customer Support

Main Office

Atlona Incorporated
70 Daggett Drive
San Jose, CA 95134
United States

Office: +1.408.962.0515

Sales and Customer Service Hours
Monday - Friday: 6:00 a.m. - 4:30 p.m. (PST)

<https://atlona.com/>

International Headquarters

Atlona International AG
Tödistrasse 18
8002 Zürich
Switzerland

Office: +41.43.508.4321

Sales and Customer Service Hours
Monday - Friday: 09:00 - 17:00 (UTC +1)

Operating Notes



IMPORTANT: Visit <https://www.atlona.com/product/AT-HDR-CAT-2> for the latest firmware updates and User Manual.

Warranty



To view the product warranty, use the following link or QR code:

<https://atlona.com/warranty/>.

Safety and Certification



CAUTION: TO REDUCE THE RISK OF ELECTRIC SHOCK DO NOT OPEN ENCLOSURE OR EXPOSE TO RAIN OR MOISTURE. NO USER-SERVICEABLE PARTS INSIDE REFER SERVICING TO QUALIFIED SERVICE PERSONNEL.



The exclamation point within an equilateral triangle is intended to alert the user to the presence of important operating and maintenance instructions in the literature accompanying the product.



The information bubble is intended to alert the user to helpful or optional operational instructions in the literature accompanying the product.

1. Read these instructions.
2. Keep these instructions.
3. Heed all warnings.
4. Follow all instructions.
5. Do not use this product near water.
6. Clean only with a dry cloth.
7. Do not block any ventilation openings. Install in accordance with the manufacturer's instructions.
8. Do not install or place this product near any heat sources such as radiators, heat registers, stoves, or other apparatus (including amplifiers) that produce heat.
9. Do not defeat the safety purpose of a polarized or grounding-type plug. A polarized plug has two blades with one wider than the other. A grounding type plug has two blades and a third grounding prong. The wide blade or the third prong are provided for your safety. If the provided plug does not fit into your outlet, consult an electrician for replacement of the obsolete outlet.
10. Protect the power cord from being walked on or pinched particularly at plugs, convenience receptacles, and the point where they exit from the product.
11. Only use attachments/accessories specified by Atlona.
12. To reduce the risk of electric shock and/or damage to this product, never handle or touch this unit or power cord if your hands are wet or damp. Do not expose this product to rain or moisture.
13. Unplug this product during lightning storms or when unused for long periods of time.
14. Refer all servicing to qualified service personnel. Servicing is required when the product has been damaged in any way, such as power-supply cord or plug is damaged, liquid has been spilled or objects have fallen into the product, the product has been exposed to rain or moisture, does not operate normally, or has been dropped.



FCC Compliance

FCC Compliance and Advisory Statement: This hardware device complies with Part 15 of the FCC rules. Operation is subject to the following two conditions: 1) this device may not cause harmful interference, and 2) this device must accept any interference received including interference that may cause undesired operation. This equipment has been tested and found to comply with the limits for a Class A digital device, pursuant to Part 15 of the FCC Rules. These limits are designed to provide reasonable protection against harmful interference in a commercial installation. This equipment generates, uses, and can radiate radio frequency energy and, if not installed or used in accordance with the instructions, may cause harmful interference to radio communications. However there is no guarantee that interference will not occur in a particular installation. If this equipment does cause harmful interference to radio or television reception, which can be determined by turning the equipment off and on, the user is encouraged to try to correct the interference by one or more of the following measures: 1) reorient or relocate the receiving antenna; 2) increase the separation between the equipment and the receiver; 3) connect the equipment to an outlet on a circuit different from that to which the receiver is connected; 4) consult the dealer or an experienced radio/TV technician for help. Any changes or modifications not expressly approved by the party responsible for compliance could void the user's authority to operate the equipment. Where shielded interface cables have been provided with the product or specified additional components or accessories elsewhere defined to be used with the installation of the product, they must be used in order to ensure compliance with FCC regulations.

Copyright, Trademark, and Registration

© 2024 Atlona Inc. All rights reserved. "Atlona" and the Atlona logo are registered trademarks of Atlona Inc. Pricing, specifications and availability subject to change without notice. Actual products, product images, and online product images may vary from images shown here.

HDMI™ The terms HDMI, HDMI High-Definition Multimedia Interface, HDMI trade dress and the HDMI Logos are trademarks or registered trademarks of HDMI Licensing Administrator, Inc.

Dolby, Dolby Atmos, and the double-D symbol are registered trademarks of Dolby Laboratories Licensing Corporation.

For DTS patents, see <http://patents.dts.com>. Manufactured under license from DTS, Inc. DTS, the Symbol, DTS and the Symbol together, and Digital Surround are registered trademarks and/or trademarks of DTS, Inc. in the United States and/or other countries. © DTS, Inc. All Rights Reserved.

All other trademark(s), copyright(s), and registered technologies mentioned(s) in this document are the properties of their respective owner(s).

Table of Contents

Introduction	7
Features	7
Package Contents	7
Panel Description	8
Connection Instructions	9
Connection Diagram	10
IP Configuration	11
Setting the IP Mode	11
Setting the IP Address Using Commands	12
Auto IP (APIPA) Mode	13
Device Operation	14
LED Indicators	14
Logging in to the Web Server	15
Login Registration	15
Logging in after Registration	16
Locking / Unlocking the Front Panel	17
Using the Front Panel	17
Using the Web Server	17
EDID Management	18
Learning an EDID using the Front Panel	18
Learning the EDID using the Web Server	19
Locking the EDID	19
Selecting EDID Presets	20
Changing Login Credentials	21
Changing the Username and Password	21
Controlling Audio Output	22
Audio Port Wiring	22
De-Embedding Audio	23
Adjusting the Volume Level	23
RS-232 Control	24
RS-232 Port Wiring	24
Pass-through mode	26
Control mode	27
IR Control	28
Controlling Display Devices	28
Controlling Source Devices	29
Power Button Modes	30
Normal Operation	30
Controlling Power on Sink Devices	31
Controlling Power on Sinks and the AT-HDR-CAT-2	33
Setting the Host Name	34
Resetting to Factory-Default Settings	35
Configuration and Management Interfaces	37
Web Server	37
Register page	37
Login page	38
Info page	39
A/V Settings page	40
RS-232 page	41
EDID page	42
Config page	43
HDBT page	44
System page	45

Table of Contents

Appendix	48
Updating the Firmware	48
Using the Web Server	48
Using USB	49
Default Settings	50
Specifications	51

Introduction

The Atlona **AT-HDR-CAT-2** is a high dynamic range (HDR) distribution amplifier with one HDMI® input and two HDBaseT™ outputs. Each output transmits 4K/UHD video @ 60 Hz with 4:4:4 chroma sampling plus support for HDR formats, multi-channel audio, control signals, and power up to 130 feet (40 meters) or 1080p up to 230 feet (70 meters) over Category 6/6A cable. The HDR-CAT-2 features sophisticated integration capabilities designed for commercial AV distribution applications including HDMI pass-through, audio de-embedding, EDID management, CEC display control, RS-232 and IR control extension, remote power for receivers, and HDBaseT link testing. It offers compatibility with any TCP/IP or RS-232 control system and is housed in a low-profile enclosure with external universal power supply. The HDR-CAT-2 is ideal for sending HDR and 4K/60 4:4:4 content to AT-HDR-EX-70C-RX receivers.

Features

- 4K HDR distribution amplifier with one HDMI input and two HDBaseT outputs.
- Pass-through HDMI output to support local monitor.
- 4K/UHD capability @ 60 Hz with 4:4:4 chroma sampling.
- Supports 4K HDR10 and Dolby® Vision™.
- Features visually lossless compression with no latency to enable HDR and 4K/60 4:4:4 video signal extension over HDBaseT.
- HDBaseT outputs extend HDMI, control signals, and power up to 130 feet (40 meters) for 4K HDR or 230 feet (70 meters) for 1080p with Category 6/6A.
- Bidirectional RS-232 and IR control extension for each output.
- Remotely powers compatible receivers over HDBaseT.
- CEC display control sends display power on/off commands over HDBaseT using the power button, IP, or RS-232.
- Audio de-embedding to balanced analog output with volume control for integration with a separate audio system.
- HDBaseT link test verifies cable, termination, and link quality for more reliable installations.
- Multi-channel audio pass-through.
- Cascade up to 8 units to expand system without compromising performance.
- Compliant with HDCP 2.2, the latest specification for passing protected content between devices.
- Manages EDID communications with the source through a display's EDID or internally stored EDID.
- Intuitive GUI-based configuration using integrated web server.
- Flexible control options via TCP/IP, RS-232, and IR with Atlona Velocity™ or third-party control systems.
- Easy to configure and manage using Velocity™ with Integrated AMS (Atlona Management System).
- Front panel includes LEDs for power, HDBaseT link, and HDMI signal status information as well as buttons for power and EDID control.
- Low-profile enclosure for easy installation under a table or in furniture.

Package Contents

1 x AT-HDR-CAT-2	1 x AC cord
4 x 5-pin captive screw connectors	2 x Mounting brackets
1 x 2-pin captive screw connector	4 x Mounting screws
1 x 48 V / 1.25 A power supply	4 x Feet w/ rubber grips

Panel Description

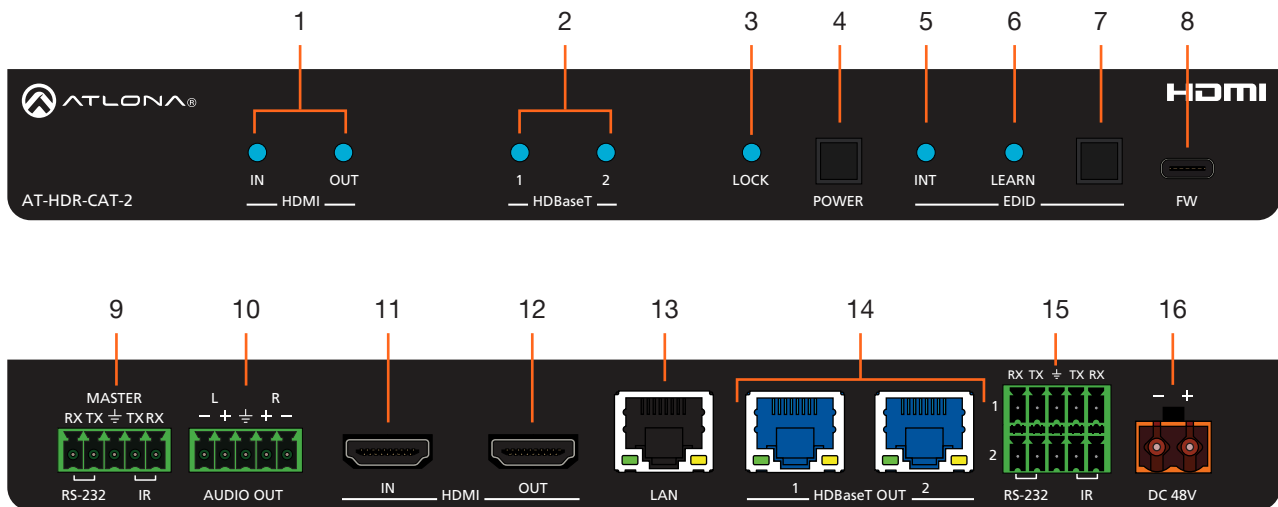

1 HDMI Indicators

Displays the status of the **HDMI IN** and **HDMI OUT** ports. When connected to a source or display (sink) device, respectively, the LED indicator will be blue.

2 HDBaseT Indicators

Displays the status of the HDBaseT OUT ports. When connected to an HDBaseT receiver, with an active sink, the LED indicator will be blue. If no active sink is connected, or the sink is powered off, then the indicator will not be illuminated.

3 Lock

This LED will be blue when the unit is locked.

4 POWER

Press this button to power-on or place the unit into standby mode.

5 INT

This LED indicator will be blue when the unit is using an internal EDID.

6 LEARN

This LED indicator will flash when a downstream EDID is being read into memory.

7 EDID

Press this button to switch between the internal (INT) and learned (LEARN) EDID modes.

8 FW

Connect a USB Type-A to USB-C cable from this port, to a computer, to update the firmware. Refer to [Updating the Firmware \(page 48\)](#) for more information.

9 RS-232 / IR (MASTER)

Connect a control system or other DTE device to this port to control the AT-HDR-CAT-2.

10 AUDIO OUT

Connect the included 5-pin captive screw connector to this port and connect it to an audio amplifier, such as an AT-GAIN-60. Refer to [Controlling Audio Output \(page 22\)](#).

11 HDMI IN

Connect an HDMI cable from this port to a source device.

12 HDMI OUT

Connect an HDMI cable from this port to an HDMI input on a local display or an additional AT-HDR-CAT-2 unit.

13 LAN

Connect an Ethernet cable from this port to the network.

14 HDBaseT OUT

Connect category cables from these ports to compatible receivers.

15 RS-232/IR 1 / 2

Connect a control system or other DTE device to these ports for pass-through zone control. Each of these ports uses the associated HDBaseT OUT port. This allows RS-232 command data to be sent to a display (sink) device connected to a compatible receiver.

16 DC 48V

Connect the included power supply to this power receptacle.

Connection Instructions

1. Connect an HDMI cable from a source to the **HDMI IN** port.
2. Connect an HDMI cable from the **HDMI OUT** port to a local display.
3. Connect up to two category cables from the **HDBaseT OUT** ports to compatible receivers. Refer to the table below for information on maximum cable length and supported resolutions.



IMPORTANT: Stranded or patch cable is not recommended due to performance issues. Shielded cables are strongly recommended to minimize signal noise and interference.

Cable	4K/UHD - Feet / Meters		1080p - Feet / Meters	
	Feet	Meters	Feet	Meters
HDMI	15	5	30	10
CAT5e/6	115	35	200	60
CAT6a/7	130	40	230	70

4. Connect an Ethernet cable from the **LAN** port to the Local Area Network (LAN). This step will be required in order to access the built-in web server.
5. Connect an RS-232 or IR cable from the control system to the RS-232/IR ports. Refer to [RS-232 Control \(page 24\)](#) and [IR Control \(page 28\)](#) for more information.
 - **MASTER RS-232/IR**
Connecting to this port will provide direct control of the AT-HDR-CAT-2. Control can be performed using either RS-232 or electrical IR.
 - **RS-232/IR 1 and RS-232/IR 2**
Each of these ports is associated to the respective **HDBaseT OUT** port. This allows RS-232 pass-through zone control of a display (sink) device that is connected to a compatible receiver. Control can be performed using RS-232 or electrical IR.
6. Connect an audio output device to the **AUDIO OUT** port. Refer to [Controlling Audio Output \(page 22\)](#) for more information.
7. Connect the included power supply to the **DC 48V** connector and connect the power cord to an available electrical outlet.

Connection Diagram

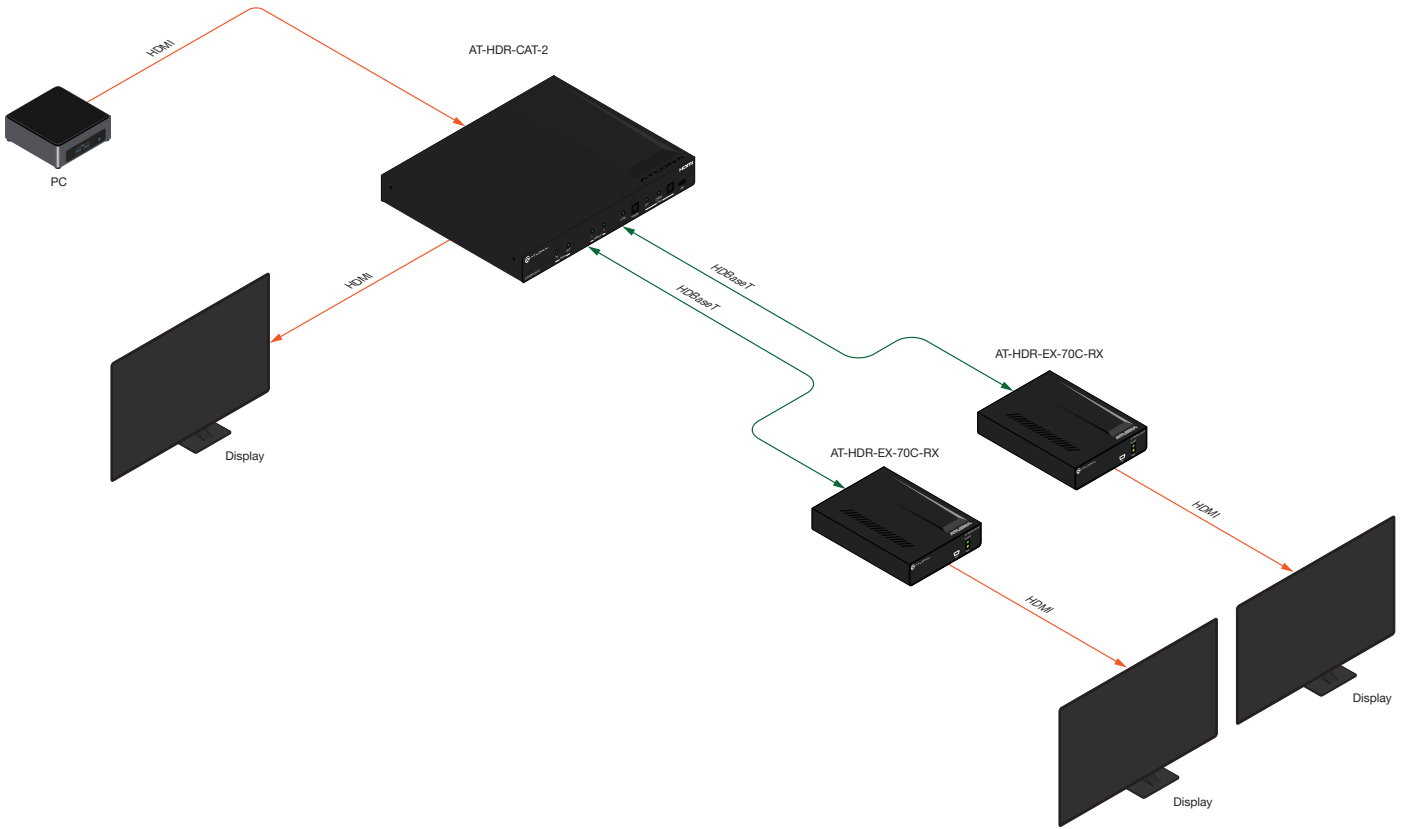

IP Configuration

The AT-HDR-CAT-2 is shipped with DHCP enabled. Once connected to a network, the DHCP server (if available), will automatically assign an IP address to the unit. If the AT-HDR-CAT-2 is unable to detect a DHCP server within 15 seconds, then the unit will use a self-assigned IP address within the range of 169.254.xxx.xxx/16. If this occurs, refer to [Auto IP \(APIPA\) Mode \(page 13\)](#).

Use an IP scanner, along with the MAC address on the bottom of the unit, to identify the unit on the network. If a static IP address is desired, the unit can be switched to static IP mode.



NOTE: When switching between DHCP and static IP mode, the AT-HDR-CAT-2 will retain the last assigned IP address until it is changed manually (static IP mode) or assigned a new IP address by the DHCP server.

Setting the IP Mode

Using the Front Panel

1. Make sure the AT-HDR-CAT-2 is powered.
2. Connect an Ethernet cable between the **LAN** port of the AT-HDR-CAT-2 and the Local Area Network (LAN).
3. Press and hold the **POWER** button for approximately 15 seconds. Release the **POWER** button once all the front-panel LED indicators begin to flash. The number of flashes will indicate the currently selected IP mode. Refer to the table, below.

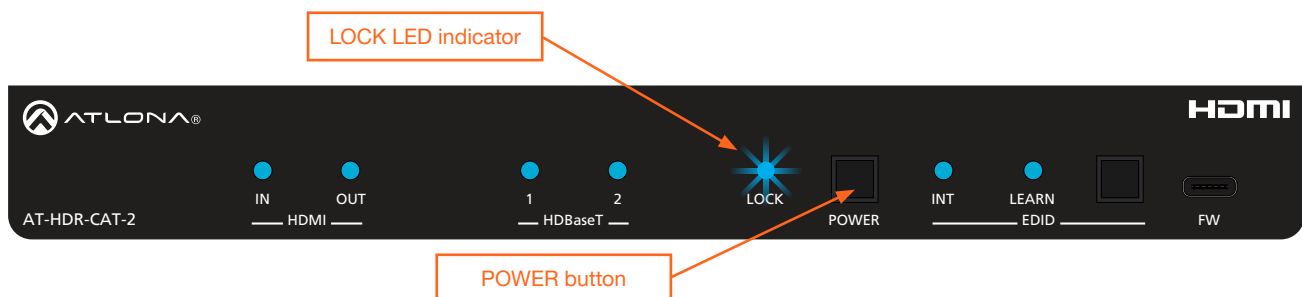

POWER button flashes	Description	
Two	Static IP mode	IP address: 192.168.1.254 Netmask: 255.255.0.0 Gateway: 192.168.1.1
Four	DHCP mode	

Using the Web Server

The IP mode of the AT-HDR-CAT-2 can also be set using the built-in web server. In order to access the web server, the IP address of the AT-HDR-CAT-2 must be known. Refer to [Logging in to the Web Server \(page 15\)](#) for more information.

1. Open the desired web browser and enter the IP address of the AT-HDR-CAT-2.
2. Log in using the required credentials.
3. Click **System** in the menu bar.
4. Click the **IP Mode** toggle to switch between the **DHCP** and **STATIC IP** setting. When set to **STATIC IP**, the **IP**, **Netmask**, and **Gateway** fields can be modified.
5. Click the **Save** button to save the changes.

MAC Address:	B8-98-B0-06-07-09		
IP Mode:	<input checked="" type="checkbox"/> STATIC IP <input type="checkbox"/>		
IP:	<input type="text" value="10.20.20.37"/>		
Netmask:	<input type="text" value="255.255.255.0"/>		<input type="button" value="Save"/>
Gateway:	<input type="text" value="10.20.20.1"/>		

Setting the IP Address Using Commands

Use the `IPStatic` and `IPDHCP` commands to switch between DHCP and IP mode through RS-232 or Telnet. Refer to API documentation for more information. All commands and their arguments are case-sensitive.



IMPORTANT: Note that when switching between DHCP and static modes, within a Telnet session, the connection will be terminated once the `IPDHCP` command is executed.

- **Setting static IP mode**

1. Connect to the AT-HDR-CAT-2 using RS-232 or Telnet.
2. Execute the `IPStatic` command. This command requires three arguments: the desired IP address of the AT-HDR-CAT-2, the subnet mask, and the gateway address. All arguments must be entered in dot-decimal notation. The following is an example:

```
IPStatic 192.168.1.112 255.255.255.0 192.168.1.1
```

└── IP address ──┘
└── Subnet mask ──┘
└── Gateway ──┘

- **Setting DHCP mode**

1. Connect to the AT-HDR-CAT-2 using RS-232 or Telnet.
2. At the command line, execute the `IPDHCP on` command using the `on` argument, as shown. All characters are case-sensitive.

```
IPDHCP on
```

Once DHCP is enabled, the unit will be assigned an IP address by the DHCP server (if present).

Auto IP (APIPA) Mode

If the AT-HDR-CAT-2 is unable to detect a DHCP server within 15 seconds, when set to DHCP mode, then the unit will use a self-assigned IP address within the IPv4 address block `169.254.xxx.xxx/16`. If this occurs, connect an Ethernet cable directly from the **LAN** port of the AT-HDR-CAT-2 to the LAN port of a computer, then do the following:

1. Click **Start > Settings > Control Panel > Network and Sharing Center**.
2. Click **Change adapter settings**.
3. Right-click on the adapter that is used to establish a wired connection to the network, and select **Properties** from the context menu.
4. Under the **Ethernet Properties** dialog box, select **Internet Protocol Version 4** and then click the **Properties** button. Click the **Use the following IP address** radio button.

















IMPORTANT: Before continuing, write down the current IP settings in order to restore them, later. If **Obtain an IP address automatically** and **Obtain DNS server automatically** are selected, then this step is not required.

5. Enter the desired static IP address or the IP address provided by the network administrator. If the computer does not require Internet access or if a statically-assigned IP address is being used, then an address within the IPv4 address block `169.254.xxx.xxx/16` can be entered.
6. Set the subnet mask to `255.255.0.0`.
7. Click the **OK** button then close all **Control Panel** windows.

Device Operation

LED Indicators

The LED indicators on both the front of the unit provide basic information on the current status of the AT-HDR-CAT-2.

LED			Description
POWER	Blue		Unit is powered and in normal operating mode.
	Red		Unit is in standby mode. <ul style="list-style-type: none"> Press the POWER button to place the unit in normal operating mode.
	Off		Unit is not powered. <ul style="list-style-type: none"> Check the power supply and make sure it is securely fastened to the locking connector on the rear of the unit. Make sure that the power supply is connected to an available electrical outlet and that the outlet is “live” (some outlets are controlled by a wall switch).
HDMI IN / OUT	Blue		IN: Source is connected to the HDMI IN port. OUT: Sink device is connected to the HDMI OUT port.
	Off		IN: No source device connected to the HDMI IN port. OUT: No sink device is connected to the HDMI OUT port. <ul style="list-style-type: none"> Check the integrity of the HDMI cable; make sure a secure connection exists between the HDMI port on the AT-HDR-CAT-2 and the source/display device. Try a different HDMI cable.
HDBaseT 1 / 2	Blue		Normal operation. Signal integrity between the AT-HDR-CAT-2 and the connected receiver is good. <i>Note that when connected to an HDBaseT receiver, with an active sink, the LED indicator will be blue. If no active sink is connected, or the sink is powered off, then the indicator will not be illuminated.</i>
	Off		No connection between the HDBaseT port on the AT-HDR-CAT-2 and the receiver unit. <ul style="list-style-type: none"> Check the category cable for a secure connection. Possible bad cable; try a different category cable.
LOCK	Blue		Front-panel buttons on the AT-HDR-CAT-2 are locked. Refer to the API or Locking / Unlocking the Front Panel (page 17) for more information.
	Flashing Blue		The number of flashes indicate whether the unit is in DHCP or static IP mode. Refer to IP Configuration (page 11) for more information.
	Off		Front-panel buttons on the AT-HDR-CAT-2 are unlocked.
INT	Blue		AT-HDR-CAT-2 is using the internal EDID. Refer to EDID Management (page 18) for more information on INT EDID mode.
	Off		AT-HDR-CAT-2 is set to LEARN EDID mode.
LEARN	Blue		AT-HDR-CAT-2 is in “learn” mode. Refer to EDID Management (page 18) for more information on LEARN EDID mode.
	Flashing Blue		AT-HDR-CAT-2 is in the process of learning the downstream EDID.
	Off		AT-HDR-CAT-2 is set to INT (internal EDID) mode.

Logging in to the Web Server

Most of the AT-HDR-CAT-2 operation is handled through the built-in web server. In order to access the web server, the IP address of the unit must be known. Refer to [IP Configuration \(page 11\)](#) for more information.

Login Registration

Before the built-in web server can be accessed, a username and password must be created.

1. Launch the desired web browser and enter the IP address of the AT-HDR-CAT-2 in the address bar.
2. The AT-HDR-CAT-2 **Register** page will be displayed.

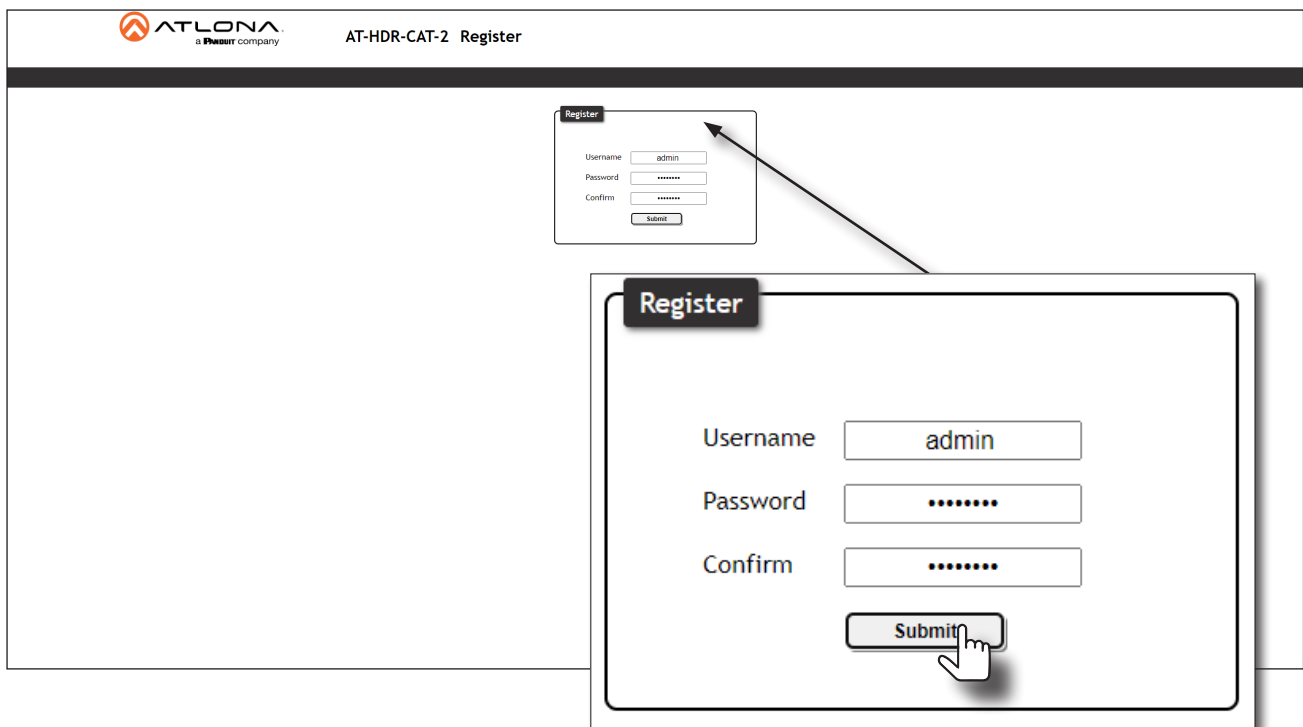

The screenshot shows the AT-HDR-CAT-2 Register page. The page header includes the ATLONA logo and the text 'AT-HDR-CAT-2 Register'. The main content area contains a registration form with the following fields: Username (admin), Password (masked with dots), and Confirm (masked with dots). A Submit button is located below the Confirm field. A callout box highlights the form fields, and a hand cursor is shown clicking the Submit button.

3. Enter the desired username in the **Username** field. In the example above, the username `admin` is used.
4. Enter the desired password in the **Password** field.



IMPORTANT: The password must contain a minimum of 8 characters, including: 1 uppercase character, 1 lowercase character, and 1 number. Special characters are not permitted. Note that the **Password** and **Confirm** fields will be masked when entering the password.

5. Verify the password by entering it in the **Confirm** field.
6. Click the **Submit** button.
7. The **Login** screen will be displayed.
8. The login registration process is complete.

Logging in after Registration

1. Launch the desired web browser and enter the IP address of the AT-HDR-CAT-2 in the address bar.
2. Enter the correct username and password in the respective fields.
3. Click the **Submit** button.

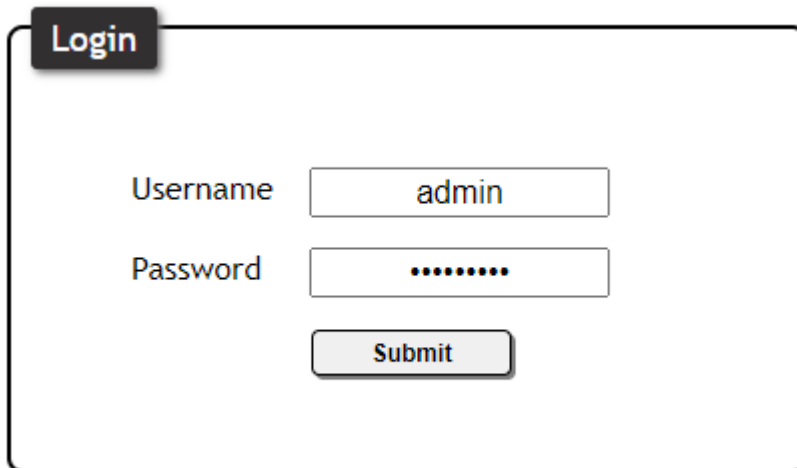

The screenshot shows a login form with a dark grey header containing the word "Login" in white. Below the header, there are two input fields. The first is labeled "Username" and contains the text "admin". The second is labeled "Password" and contains a series of ten black dots. Below these fields is a grey button with the text "Submit" in white.

4. The **Info** page will be displayed and the login process is complete. Refer to [Info page \(page 39\)](#) for more information.

Locking / Unlocking the Front Panel

The buttons on the front panel can be locked or unlocked. Locking the front-panel buttons prevents accidental pressing of the buttons, which may occur when the unit is mounted in a rack environment. Locking and unlocking of the front-panel buttons is managed through the web server or by executing the `Lock` and `Unlock` API commands. Refer to the API documentation for more information.

NOTE: Locking the front-panel buttons will also lock the EDID, preventing the EDID mode from being switched between **INT** and **LEARN** modes.

Using the Front Panel

1. Make sure the unit is powered.
2. Press and hold the **POWER** button for five seconds.
3. Release the **POWER** button. The **LOCK** LED indicator on the front panel will glow solid blue. The front panel buttons are now locked.
4. To unlock the front-panel buttons, press and hold the **POWER** button for five seconds, then release. The **LOCK** LED indicator will no longer be illuminated.

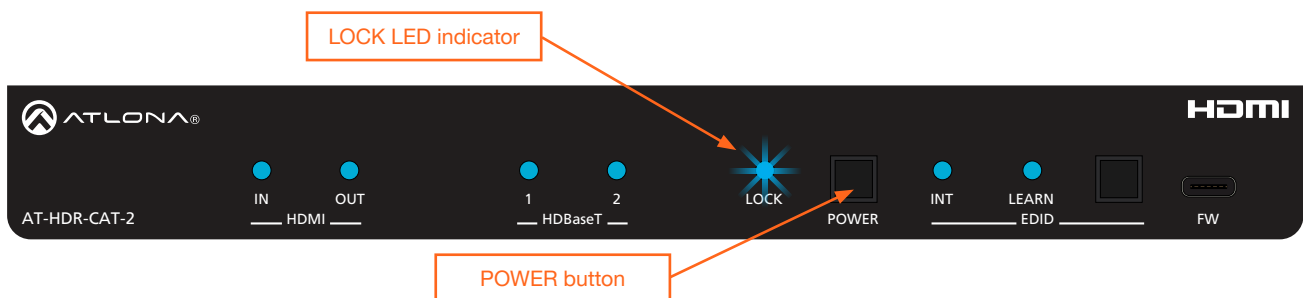

Using the Web Server

1. Log in to the web server.
2. Click **System** in the menu bar.
3. Locate the **System** section and click the **Lock** toggle button to switch between **LOCK** and **UNLOCK** states.

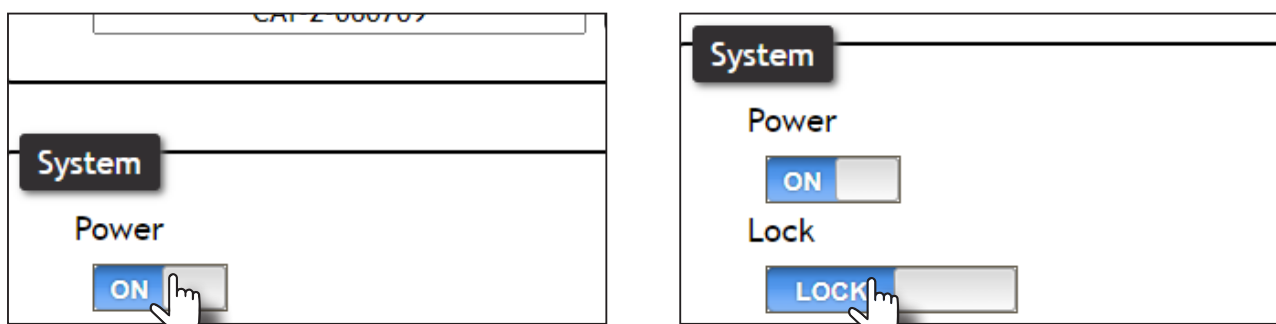

4. The **LOCK** LED indicator, on the front panel, will reflect the current state. When the front-panel buttons are locked, the **LOCK** LED indicator will glow solid blue.

EDID Management

The AT-HDR-CAT-2 provides two EDID modes: **INT** and **LEARN**. The default EDID mode is **INT** mode. In this mode, the AT-HDR-CAT-2 will automatically create an EDID based on the capabilities of all connected displays. **INT** mode is recommended for the best results when the capabilities of all connected displays are unknown. **INT** mode can also be used to select any of 9 EDID presets. Refer to [Selecting EDID Presets \(page 20\)](#) for more information on this topic. **LEARN** mode can be used to capture an EDID from any sink device. Once the EDID is learned, it will be used by the connected source device to determine what video and audio formats can be sent to the sink device.

Learning an EDID using the Front Panel



IMPORTANT: In order for EDID learning to take place, a display must be connected to **HDBaseT OUT 1**.

1. Power the AT-HDR-CAT-2.
2. Connect a category cable from the **HDBaseT OUT 1** port on the AT-HDR-CAT-2 to a receiver (e.g. AT-HDR-EX-70C-RX).
3. Connect an HDMI cable from the receiver to the display (sink) device. Make sure that the sink device is powered.

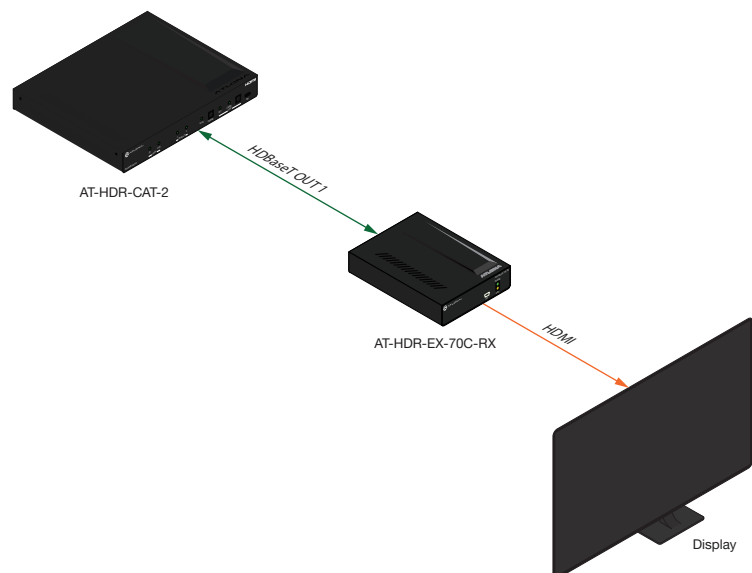

4. Press and hold the **EDID** button on the AT-HDR-CAT-2. Release the **EDID** button once the **LEARN** LED indicator begins to flash rapidly.

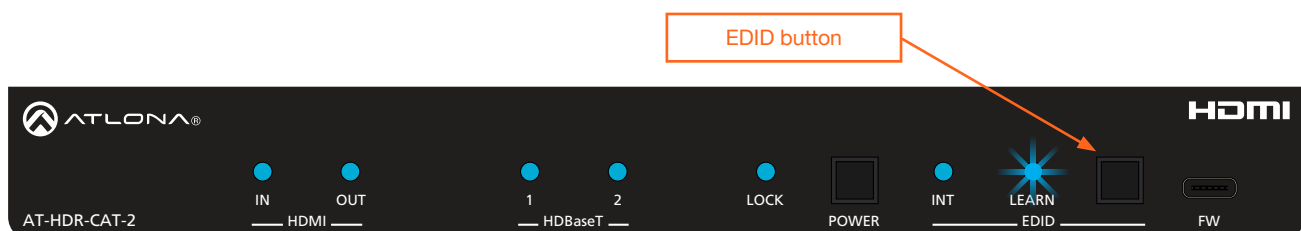

Once the EDID is learned, it will be used by the connected source device to determine what video and audio formats can be sent to the sink device(s). To switch back to **INT** mode, quickly press and release the **EDID** button.



NOTE: If the AT-HDR-CAT-2 is accidentally switched to **INT** mode, quickly press and release the **EDID** button to switch back to **LEARN** mode. Switching back and forth between **INT** and **LEARN** mode will not erase the “learned” EDID. In addition, switching to **LEARN** mode cannot be performed if an EDID has not been learned.

Learning the EDID using the Web Server

1. Follow steps 1 through 3 under [Learning an EDID using the Front Panel \(page 18\)](#).
2. Log in to the web server.
3. Click **EDID** in the menu bar.

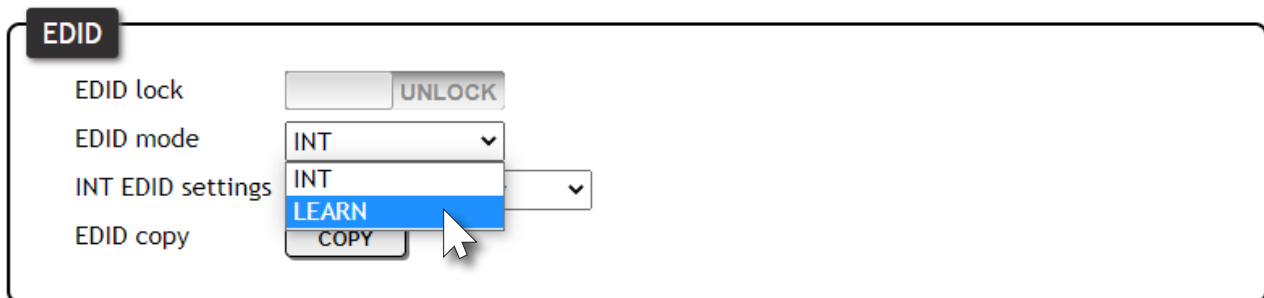

4. Click the **EDID mode** drop-down list and select **LEARN**.
5. Click the **COPY** button to copy the downstream EDID to memory.

The AT-HDR-CAT-2 will now use the EDID of the downstream sink. To switch back to the **INT** mode, click the **EDID mode** drop-down list and select **INT**.

i NOTE: The **COPY** button will be disabled if there is no display connected to **HDBaseT OUT 1**.

Locking the EDID

To prevent accidental switching between **INT** and **LEARN** modes, the EDID can be locked.

i NOTE: Locking the EDID will also lock all front-panel buttons.

1. Log in to the web server.
2. Click **EDID** in the menu bar.
3. Click the **EDID lock** toggle button to switch between **LOCK** and **UNLOCK** states.

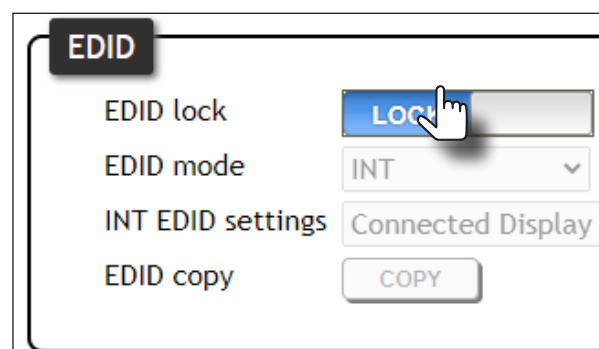
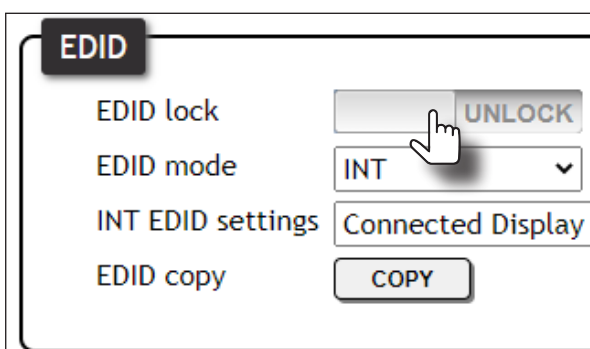

4. The **LOCK** LED indicator, on the front panel, will reflect the current state. When the EDID is locked, the **LOCK** LED indicator will glow solid blue. This also serves to indicate that all front-panel buttons are locked.

Selecting EDID Presets

The AT-HDR-CAT-2 comes with a default EDID plus 8 pre-programmed EDID selections. When selecting the default or one of the pre-programmed EDID selections, the EDID mode must be set to **INT** (internal) mode.

Available EDID selections are presented in the table below. All resolutions are 60 Hz.

EDID	Description
Connected Display	Uses the downstream EDID of the connected display
ATL 4K60 MCH	3840 x 2160 (UHD) with multichannel audio support
ATL 4K60 PCM MCH	3840 x 2160 (UHD) with PCM multichannel audio support
ATL 1080P MCH	1920 x 1080p with multichannel audio support
ATL 1080P 2CH	1920 x 1080p with two-channel audio support
ATL 1080P DD	1920 x 1080p with Dolby™ Digital audio support
ATL 1080P DVI	1920 x 1080p for DVI displays
ATL 720P DD	1280 x 720p with Dolby™ Digital audio support
ATL 720P 2CH	1280 x 720p with two-channel audio support



NOTE: If the resolution and timing limitations of both displays, connected to the **HDBaseT OUT** port, are unknown, then select the **Connected Display** EDID for the best compatibility. The **Connected Display** EDID will automatically build an EDID based on the capabilities of both displays. When selecting an EDID, make sure both connected displays can support the resolution and timing information. Otherwise, loss of picture and/or audio may result.

1. Log in to the web server.
2. Click **EDID** in the menu bar.
3. Make sure the **EDID lock** toggle switch is set to **UNLOCK**.
4. Click the **EDID mode** drop-down list and select **INT**.
5. Select the desired EDID from the **INT EDID settings** drop-down list. The selected EDID will be used by the source, before sending A/V data to the display (sink) device.

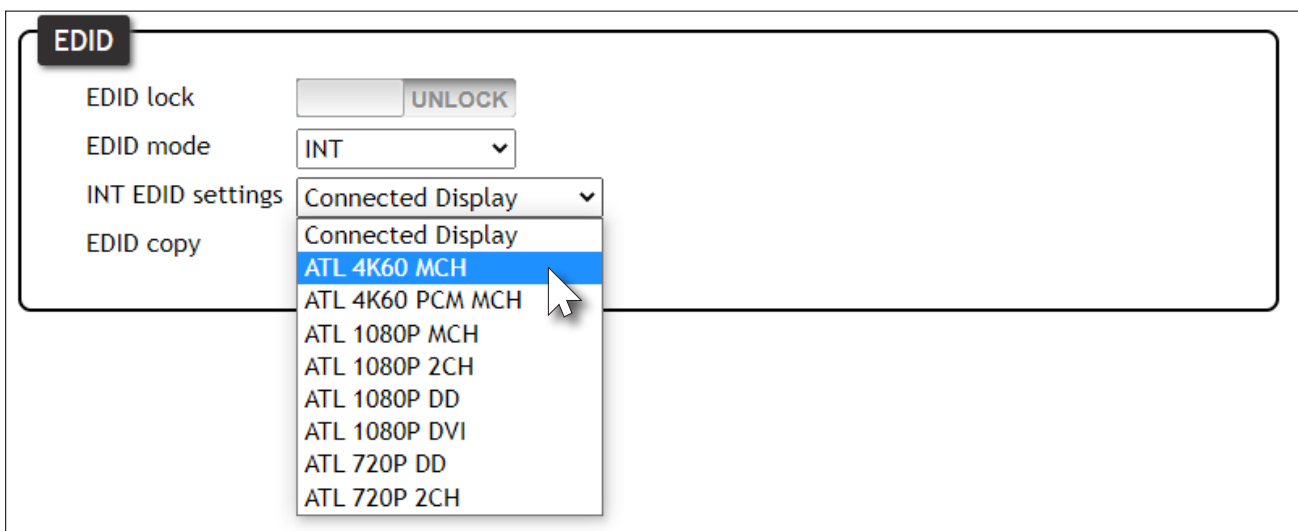

Changing Login Credentials

The AT-HDR-CAT-2 allows both the username and password to be changed. These credentials apply to both the built-in web server and Telnet sessions.



NOTE: When creating passwords, special characters are not supported. Password fields will always be masked for security purposes.

Changing the Username and Password

1. Log in to the web server.
2. Click **Config** in the menu bar.
3. Click the **Old Username** field and enter the current username.

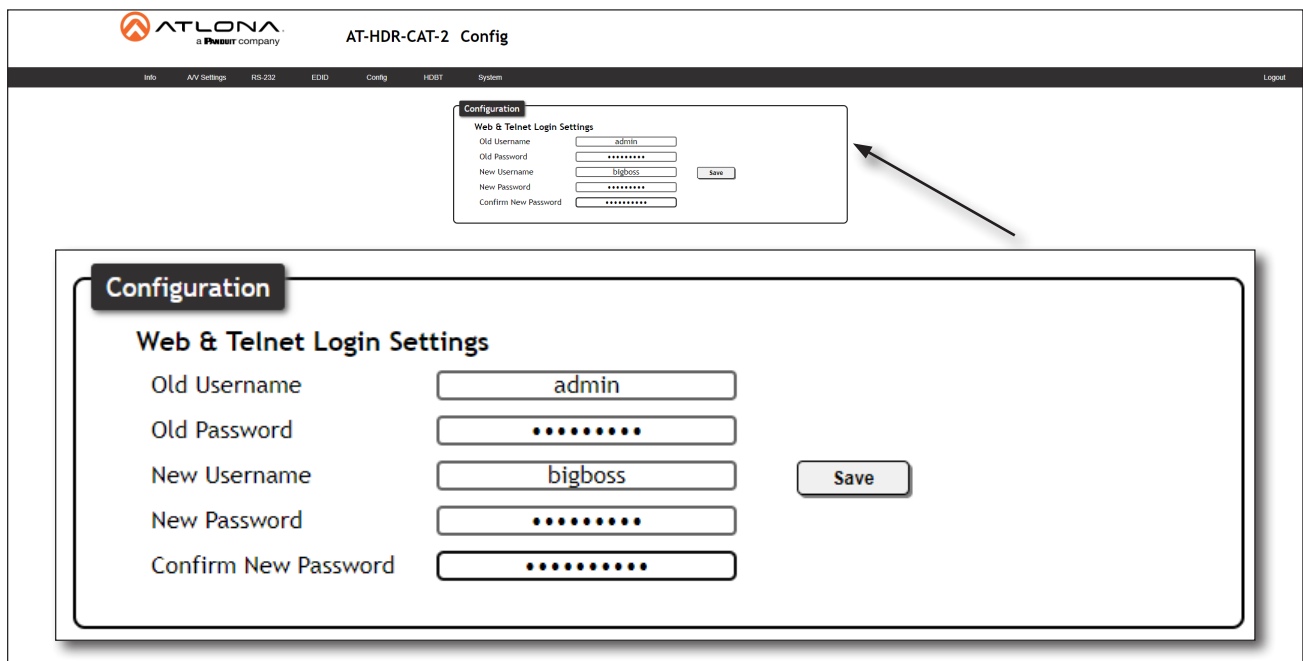

The screenshot shows the AT-HDR-CAT-2 Config page. The top navigation bar includes 'Info', 'AV Settings', 'RS-232', 'EDID', 'Config', 'HDMI', and 'System'. The main content area is titled 'Configuration' and contains a 'Web & Telnet Login Settings' form. The form has the following fields and values:

Field	Value
Old Username	admin
Old Password	*****
New Username	bigboss
New Password	*****
Confirm New Password	*****

A 'Save' button is located to the right of the form. A callout box highlights the form, and an arrow points to the 'Save' button.

4. Enter the current password in the **Old Password** field.
5. Enter the new username in the **New Username** field.
6. Enter the new password in the **New Password** field.
7. Retype the new password in the **Confirm New Password** field.
8. Click the **Save** button to commit changes. To log in with the new username, click **Logout** in the upper-right corner of the screen, then enter the new password on the **Login** page.

Controlling Audio Output

The AT-HDR-CAT-2 features a separate **AUDIO OUT** port on the rear panel. This port provides de-embedding and conversion of two-channel LPCM audio streams to analog audio. Audio output volume can be controlled using API commands or the built-in web server.



IMPORTANT: The AT-HDR-CAT-2 will only de-embed two-channel LPCM audio. Down-mixing multichannel audio to two-channel audio is not supported. In addition, video must accompany the audio at all times. This product does not support audio-only (“free-run” mode) output.

Audio Port Wiring

The included 5-pin captive screw block can be wired to support balanced audio using XLR connectors, or unbalanced audio using RCA connectors.

Balanced Audio (XLR)

Channel	Signal (AT-HDR-CAT-2)	Pin (XLR)
R	-	3
R	+	2
--	GND*	1
L	+	2
L	-	3

*The **GND** signal, from the 5-pin captive screw connector on the AT-HDR-CAT-2, should be tied to pin 1 on *both* XLR connectors.

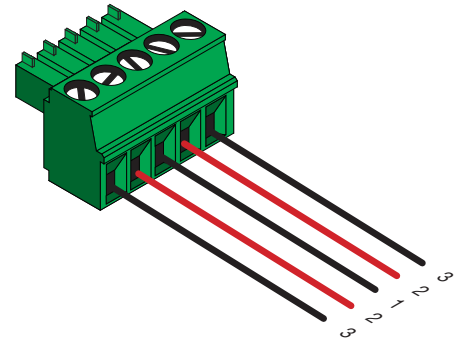

Unbalanced Audio (RCA)

Channel	Signal (AT-HDR-CAT-2)	Pin (RCA)
R	to GND*	--
R	+	+
--	GND	GND
L	+	+
L	to GND*	--

*The **GND** signal, from the captive screw connector on the AT-HDR-CAT-2, should be tied to **L-** and **R-** on the captive screw connector.

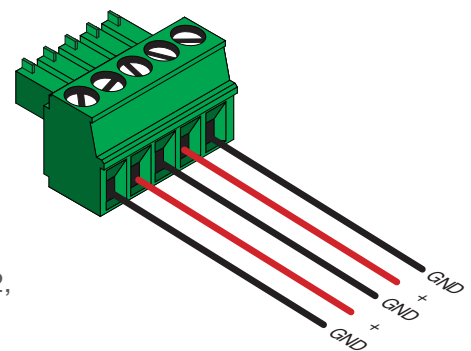

De-Embedding Audio

1. Log in to the web server.
2. Click **A/V Settings** in the menu bar.
3. Click **Analog Output** toggle switch and set to the **ON** position. To mute the audio output on the **AUDIO OUT** port, click this toggle switch to the **OFF** position.

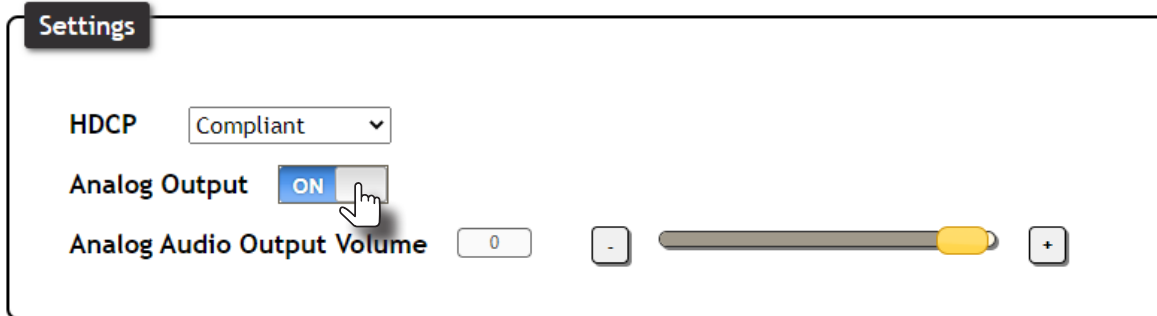

Adjusting the Volume Level

1. Log in to the web server.
2. Click **A/V Settings** in the menu bar.
3. Click and drag the **Analog Audio Output Volume** slider to the right to increase the output level. Drag the slider to the left to decrease the output level.

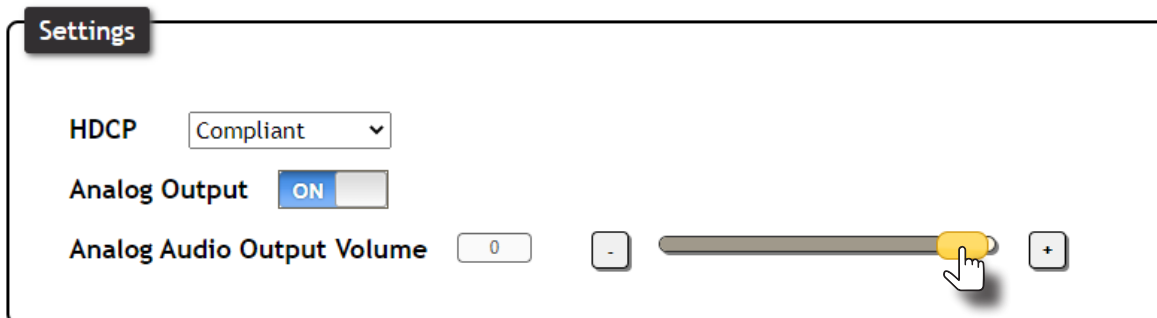

RS-232 Control

The AT-HDR-CAT-2 provides two methods of RS-232 control: Pass-through mode and control mode. The **MASTER RS-232 / IR** port, allows the unit to be directly controlled using a control system. In addition two pass-through **RS-232 / IR** ports allow sink devices, at the viewing location, to be controlled using a control system.

RS-232 is serial data protocol that allows Data Terminal Equipment (DTE) devices, such as a computer or control system, to communicate with Data Communication Equipment (DCE) devices, such as the AT-HDR-CAT-2 or a display. Although IP control is available, RS-232 still plays an integral part of many control systems.

The 25-pin D-type connector (DB-25) was defined as the RS-232 standard, but is now commonly implemented in a nine-pin (DE-9) connector package. Each pin is numbered, as shown below.



DTE Pin Descriptions

Pin	Signal	Description
1	DCD	Data Carrier Detect
2	RxD	Receive Data
3	TxD	Transmit Data
4	DTR	Data Terminal Ready
5	GND	Ground (Signal)
6	DSR	Data Set Ready
7	RTS	Request to Send
8	CTS	Clear to Send
9	RI	Ring Indicator

DCE Pin Descriptions

Pin	Signal	Description
1	DCD	Data Carrier Detect
2	TxD	Transmit Data
3	RxD	Receive Data
4	DSR	Data Set Ready
5	GND	Ground (Signal)
6	DTR	Data Terminal Ready
7	CTS	Clear to Send
8	RTS	Ready to Send
9	RI	Ring Indicator

RS-232 Port Wiring

When connecting a DTE device to a DCE device, a *straight-through* cable should be used. A straight-through cable is wired in such a way that the pins on one side of the cable are connected to the corresponding pins on the opposite side of the cable, as shown in the table below. However, the AT-HDR-CAT-2 will use only TxD, RxD, and GND signals when communicating with a control system or computer. Refer to connection instructions on the next page.

Straight-Through Cable

Pin	Signal		Signal	Pin
1	DCD	←→	DCD	1
2	RxD	←→	TxD	2
3	TxD	←→	RxD	3
4	DTR	←→	DSR	4
5	GND	←→	GND	5
6	DSR	←→	DTR	6
7	RTS	←→	CTS	7
8	CTS	←→	RTS	8
9	RI	←→	RI	9

Device Operation

1. Identify the DE-9 connector that will be attached to the control system or computer (DCE) equipment.
2. Remove the DE-9 connector at the opposite end of the cable with wire cutters.
3. Remove at least 1" of the cable insulation to expose each of the nine wires.
4. Locate a multimeter and set it to the "continuity" function.
5. Attach one of the leads from the multimeter to pin 2 on the DE-9 connector.
6. Take the other lead and probe each of the wires on the opposite end of the cable. When the wire connected to that pin is detected, the multimeter will emit an audible tone. Once this occurs, identify the current wire, and move it to the side.
7. Repeat step 6 for pin 3 and pin 5 on the DE-9 connector.
8. Group the remaining wires and pull them aside. Electrical tape can be use to secure the wires to the outside of the RS-232 cable.
9. Remove at least 3/16" (5 mm) of insulation from the TxD, RxD, and GND wires.

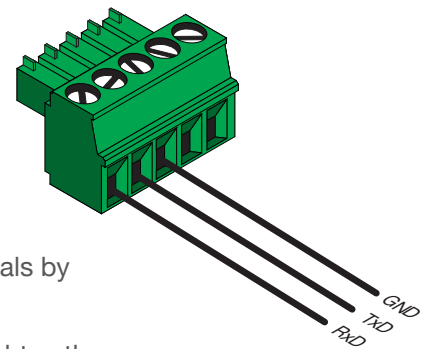
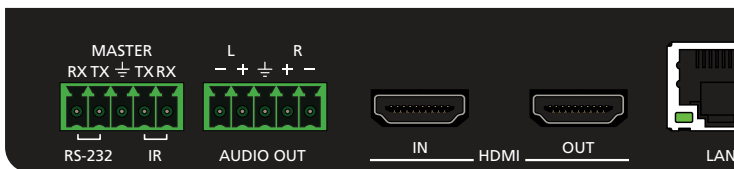

10. Locate the included 5-pin captive screw block and open each of the terminals by turning the screws counter-clockwise, using a small regular screwdriver.
11. Insert the TxD, RxD, and GND wires into correct terminal, as shown, and tighten the screws to secure each wire. Do not overtighten.

Pass-through mode

In pass-through mode, RS-232 commands are passed-through the AT-HDR-CAT-2, transmitted over HDBaseT to a receiver unit, and then to the display (sink) device. Note that each **RS-232 / IR** port is assigned to an **HDBaseT OUT** port. This assignment is fixed and cannot be changed, as shown in the table below.

RS-232 / IR Port	HDBaseT Port
RS-232 / IR 1	HDBaseT OUT 1
RS-232 / IR 2	HDBaseT OUT 2

1. Connect the RS-232 cable from the control system to the desired **RS-232 / IR** port on the AT-HDR-CAT-2. Refer to [RS-232 Port Wiring \(page 24\)](#) for instructions on preparing the cable.
2. Connect a category cable from the desired **HDBaseT OUT** port to a receiver. In this example, the HDBaseT cable is connected from **HDBaseT OUT 2** to a compatible receiver (the RS-232 cable is connected from the control system to the **RS-232 / IR 2** port).
3. Connect an RS-232 cable between the display (sink) and the receiver.
4. Adjust the RS-232 settings on the control system to match the requirements of the sink device. For example, if the RS-232 settings for the display device are 9600, N, 8, 1, then set the control system to the same settings. If the control system and sink device settings do not match, then RS-232 control will not function.

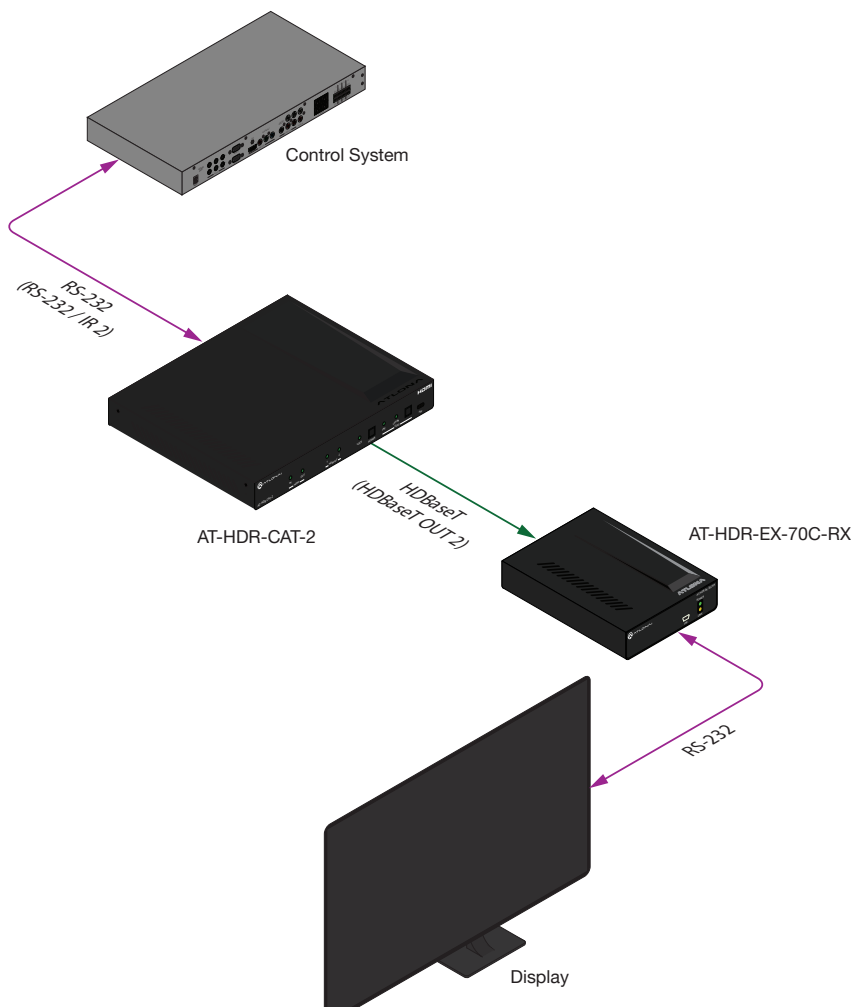

Control mode

In control mode, the **MASTER RS-232 / IR** port is used to directly control the AT-HDR-CAT-2 using a control system.

1. Launch a web browser and log in to the web server.
2. Connect the RS-232 cable between the control system and the **MASTER RS-232 / IR** port on the AT-HDR-CAT-2. Refer to [RS-232 Port Wiring \(page 24\)](#) for instructions on preparing the cable.

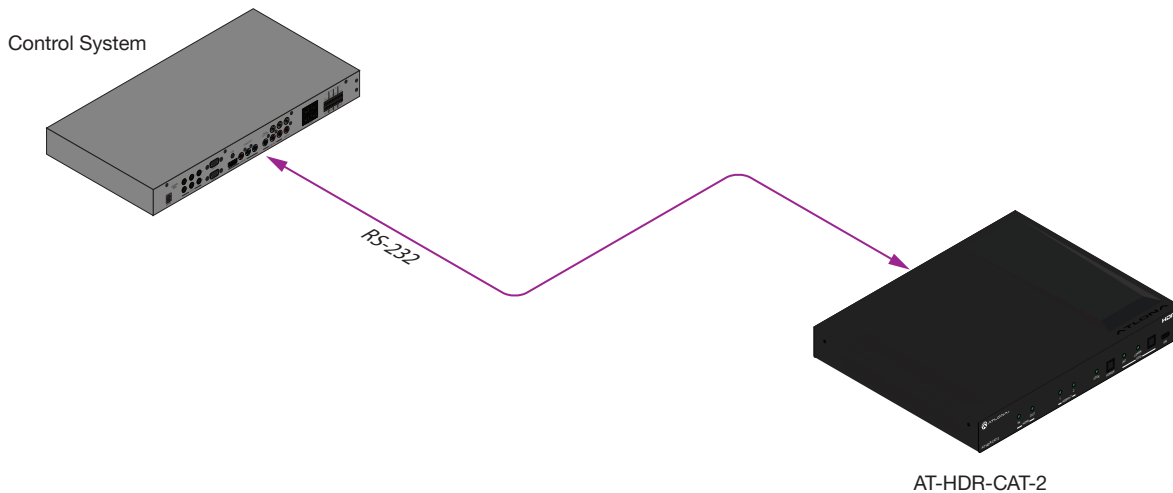

3. Click **RS-232** in the menu bar.
4. Select the proper baud rate, data bit, parity, and stop bit settings. These settings must correspond with the control system RS-232 settings.

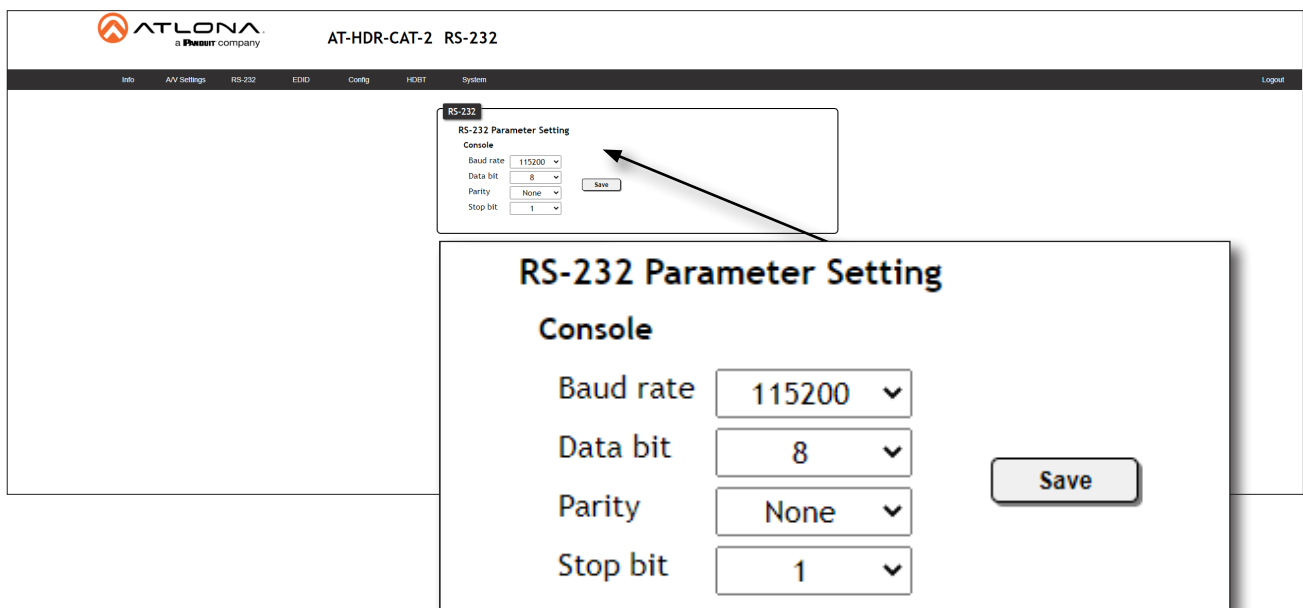

5. Click the **Save** button to commit changes.

IR Control

IR can be used to control either source devices at the headend or devices connected to the receiver endpoint, such as a display. Note that the **MASTER RS-232 / IR** port does *not* support IR control. Each **RS-232 / IR** port is assigned to an **HDBaseT OUT** port. This assignment is fixed and cannot be changed, as shown in the table below. IR is compatible with frequencies from 30 kHz to 60 kHz.

RS-232 / IR Port	HDBaseT Port
RS-232 / IR 1	HDBaseT OUT 1
RS-232 / IR 2	HDBaseT OUT 2

Controlling Display Devices

1. Remove at least 3/16" (5 mm) of insulation from the TX and GND wires.
2. Locate the included 5-pin captive screw block and open each of the terminals by turning the screws counter-clockwise, using a small regular screwdriver.
3. Insert the TX and GND wires into correct terminal, as shown, and tighten the screws to secure each wire. Do not overtighten.
4. Connect the captive screw connector to the **RS-232 / IR IN** port of the zone to be controlled.
5. Connect the RX terminal, from the AT-HDR-CAT-2, to the TX terminal on the control system.
6. Connect the GND terminal, from the AT-HDR-CAT-2, to the GND terminal on the control system.

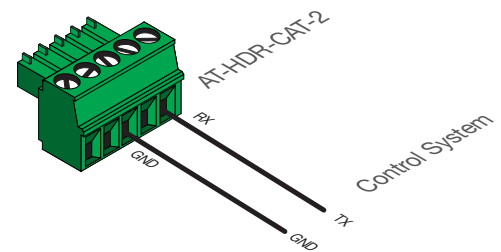
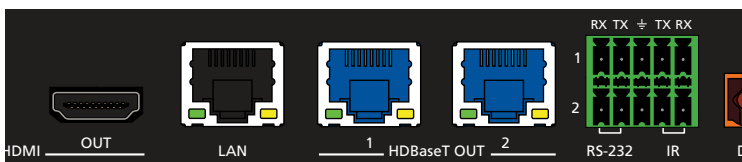

7. Connect the IR emitter to the receiver and place the emitter next to the display (sink) device, as shown in the illustration below.

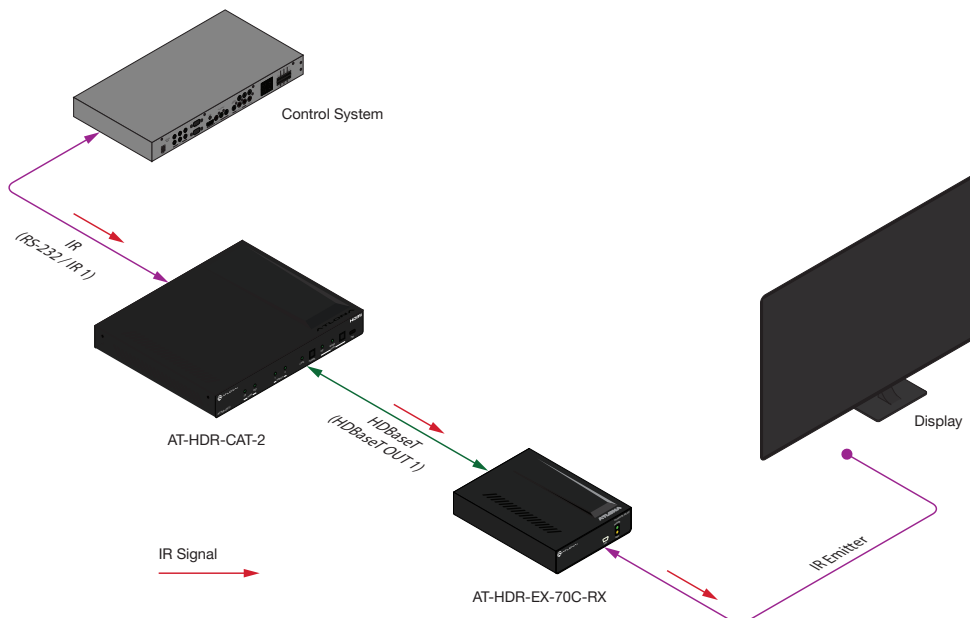

Controlling Source Devices

1. Remove at least 3/16" (5 mm) of insulation from the RX and GND wires of the emitter.
2. Locate the included 5-pin captive screw block and open each of the terminals by turning the screws counter-clockwise, using a small regular screwdriver.
3. Insert the S (signal) lead of the IR emitter to the TX terminal on the AT-HDR-CAT-2 captive screw connector. Tighten the screw to secure the wire but do not overtighten.
4. Insert the GND lead of the IR emitter to the GND terminal on the AT-HDR-CAT-2 captive screw connector. Tighten the screw to secure the wire but do not overtighten.
5. Connect the captive screw connector to the **RS-232 / IR IN** port of the zone to be controlled.

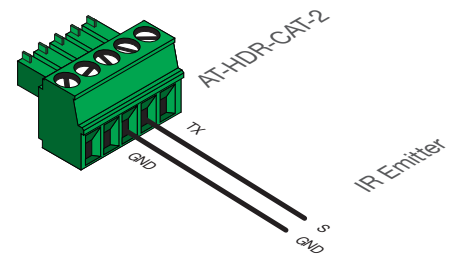
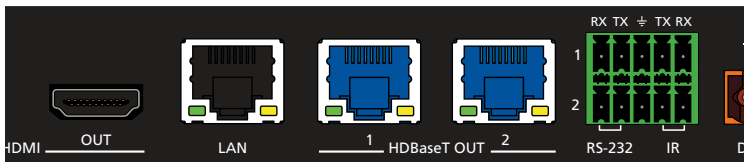

6. Place the IR emitter next to the source device, as shown in the illustration below.

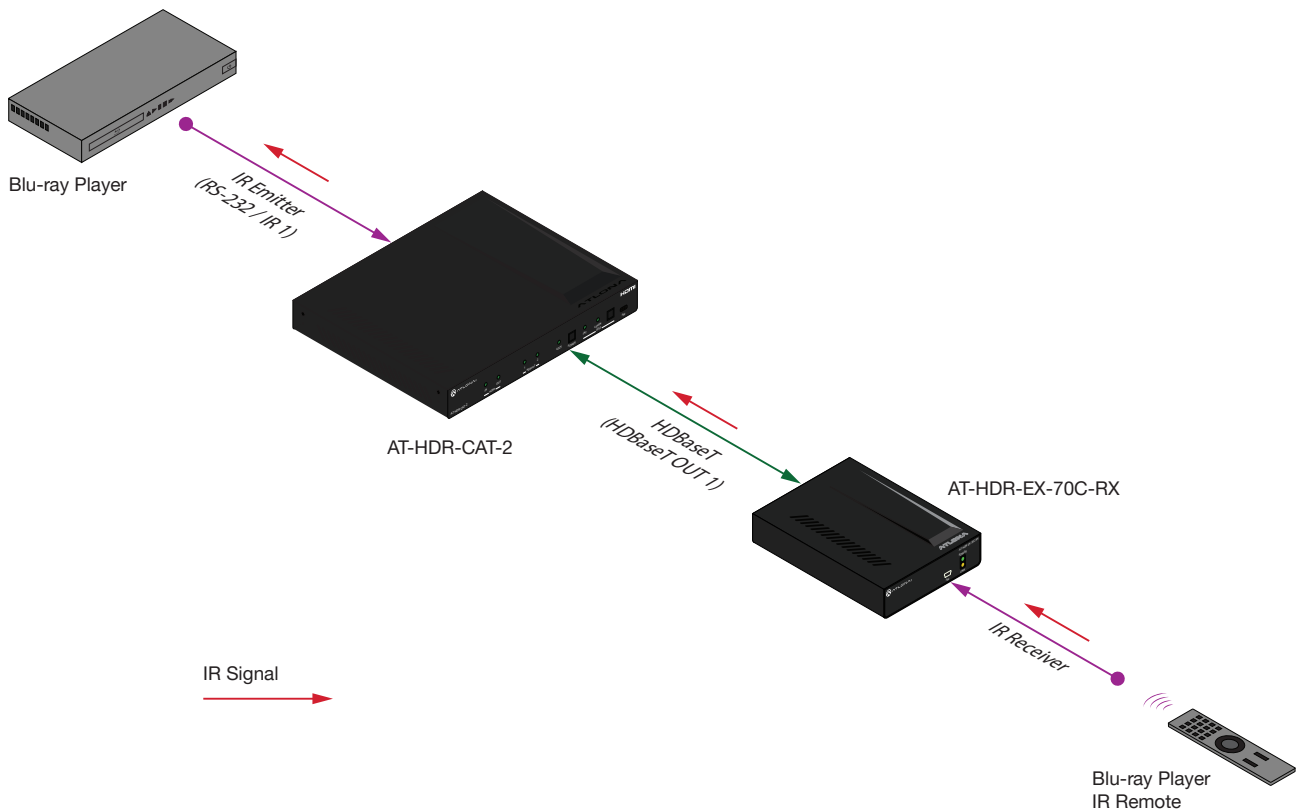

Power Button Modes

The main function of the **POWER** button on the front panel is to toggle the AT-HDR-CAT-2 between standby and normal operating mode. This is the default mode. However, this button can also be defined to send CEC power-on and power-off commands, over HDBaseT, to the display (sink) devices. It can also be defined to simultaneously power-on or power-off the AT-HDR-CAT-2 and any connected displays.

Normal Operation

By default, pressing the **POWER** button will toggle the power state of the AT-HDR-CAT-2. When the unit is in normal operating mode, the **POWER** button will be blue. Pressing the **POWER** button again, will place the unit into standby mode, and the **POWER** button will be red. In standby mode, no video signal will pass to the display (sink) device. However, TCP/IP access to the unit will be maintained, allowing access to the web server and Telnet sessions.

1. Launch a web browser and log in to the web server.
2. Click **System** in the menu bar.
3. Click the **Power button mode** drop-down list and select **DA standby**. Pressing the **POWER** button on the front panel will toggle between power-on and standby modes on the AT-HDR-CAT-2. Connected display (sink) devices will not receive CEC power-on / power-off messages.

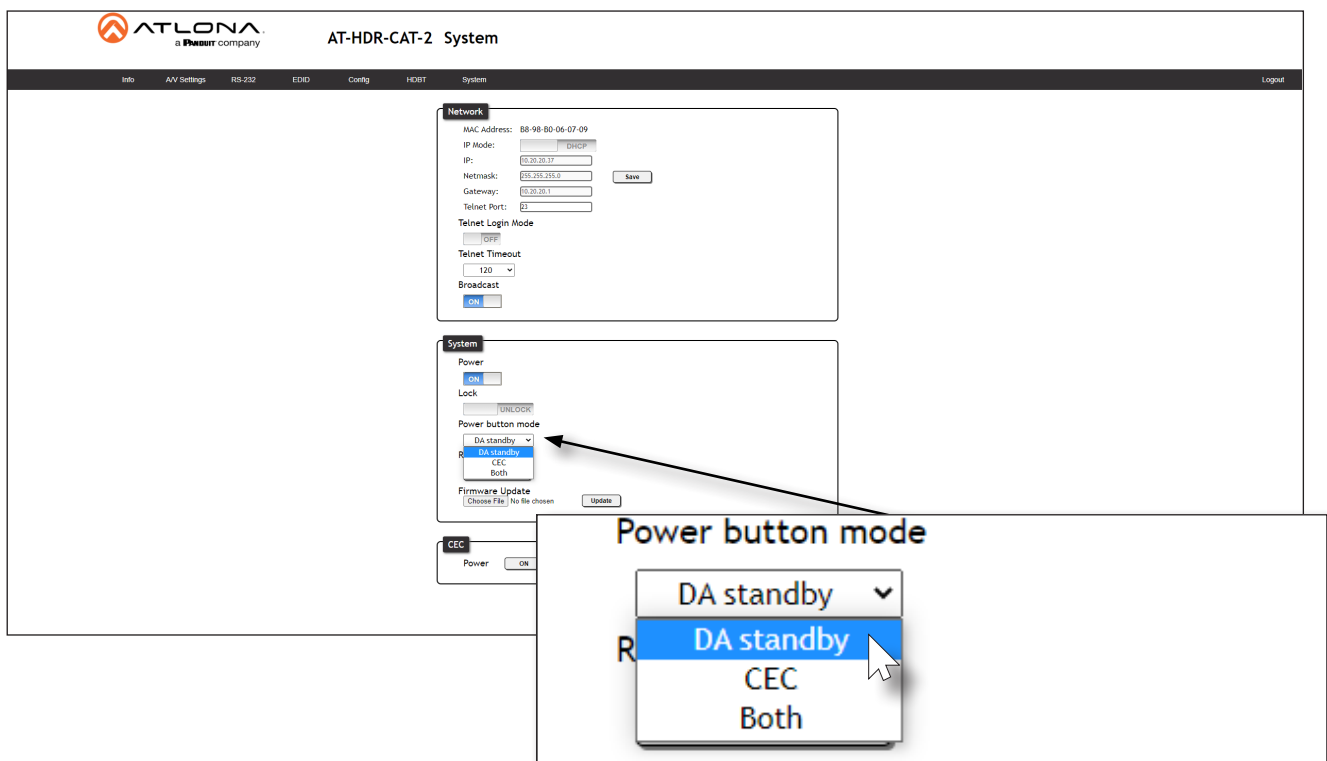

Controlling Power on Sink Devices

This section provides information on how to power-on / power-off the display (sink) device, using the **POWER** button. CEC* power-on / power-off commands are transmitted over both **HDBaseT OUT** ports, as well as the pass-through **HDMI OUT** port.

1. Connect category cables from the **HDBaseT OUT** ports to receiver (e.g. AT-HDR-EX-70C-RX).
2. Connect an HDMI cable from the receiver to the display (sink) device. Make sure that the sink device is powered.

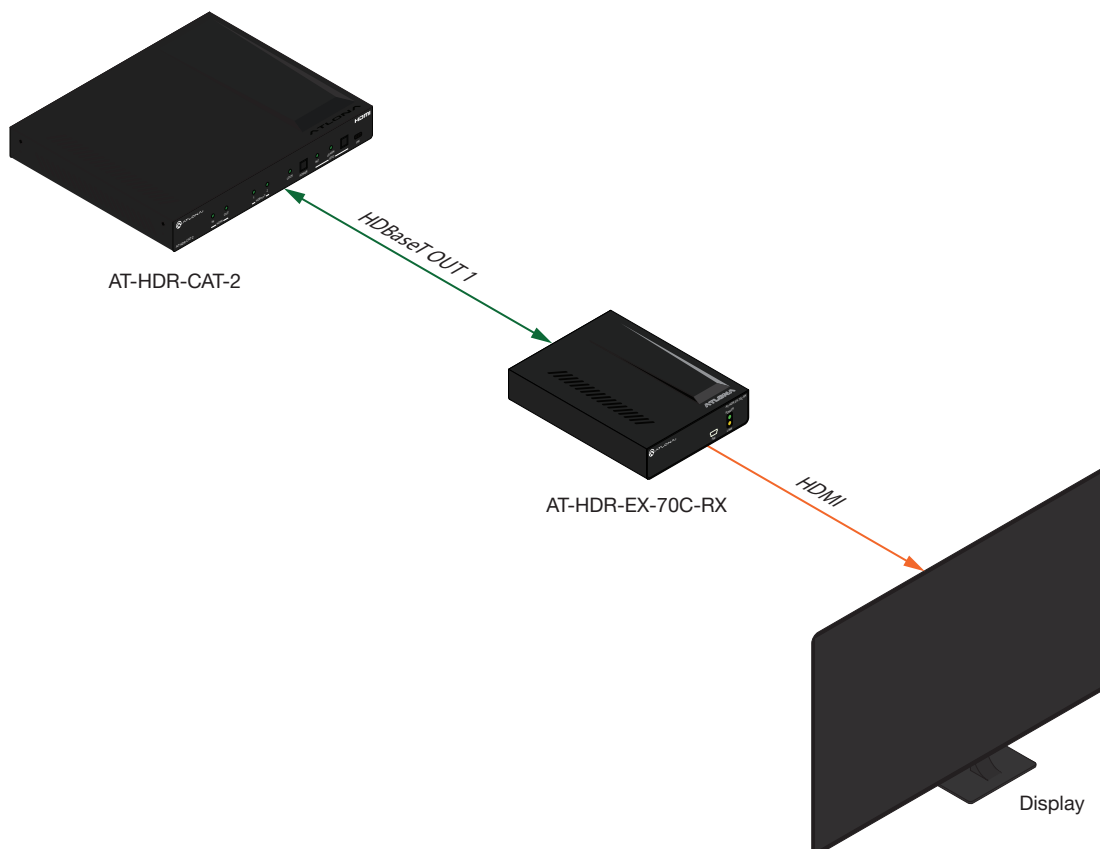

3. Launch a web browser and log in to the web server.
4. Click **System** in the menu bar.
5. Click the **Power button mode** drop-down list and select **CEC**. Refer to the illustration on the next page.

**Consumer Electronics Control (CEC): Atlona has confirmed proper CEC functionality with several current models of Samsung, Panasonic, and Sony displays. However, it is not guaranteed that CEC will work with all displays. Many manufacturers do not support the CEC "off" command, and older displays use proprietary commands. Atlona only supports displays that use the CEC command structure defined in HDMI 1.2a. It is recommended that dealers request an evaluation product from Atlona, before designing a system using the CEC protocol. If this is not possible, then other control methods will need to be considered, in order to control displays using Atlona products.*

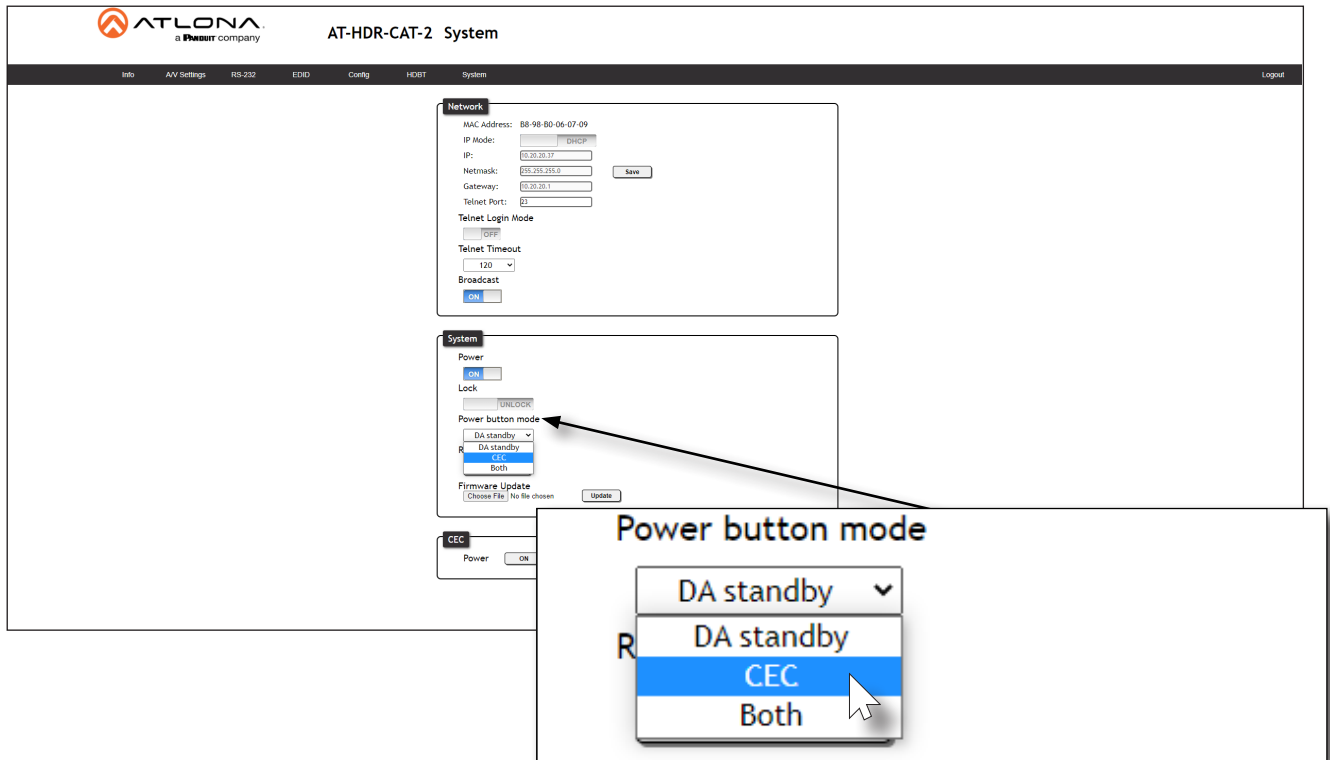

6. Test the CEC power-on and power-off commands by clicking the **ON** and **OFF** buttons, near the bottom of the page.

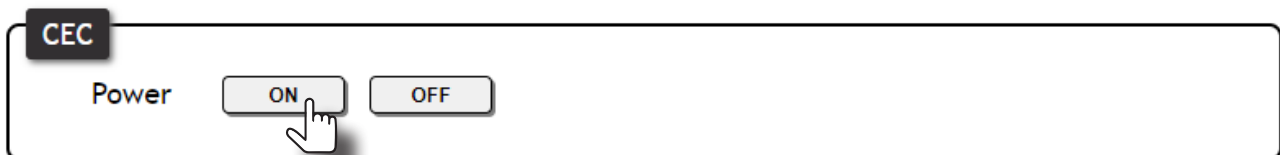

7. Press the **POWER** button on the front panel to power-on or power-off the display. Note that the power state of the AT-HDR-CAT-2 will be unaffected.

Controlling Power on Sinks and the AT-HDR-CAT-2

In this mode, the **POWER** button will power-on / power-off the unit and the connected displays. CEC* power-on / power-off commands are transmitted over both **HDBaseT OUT** ports.

1. Make the proper connections by following steps 1 and 2, under [Controlling Power on Sink Devices \(page 31\)](#).
2. Launch a web browser and log in to the web server. Refer to [Introduction to the Web Server \(page 29\)](#) for more information.
3. Click the **Power button mode** drop-down list and select **Both**.

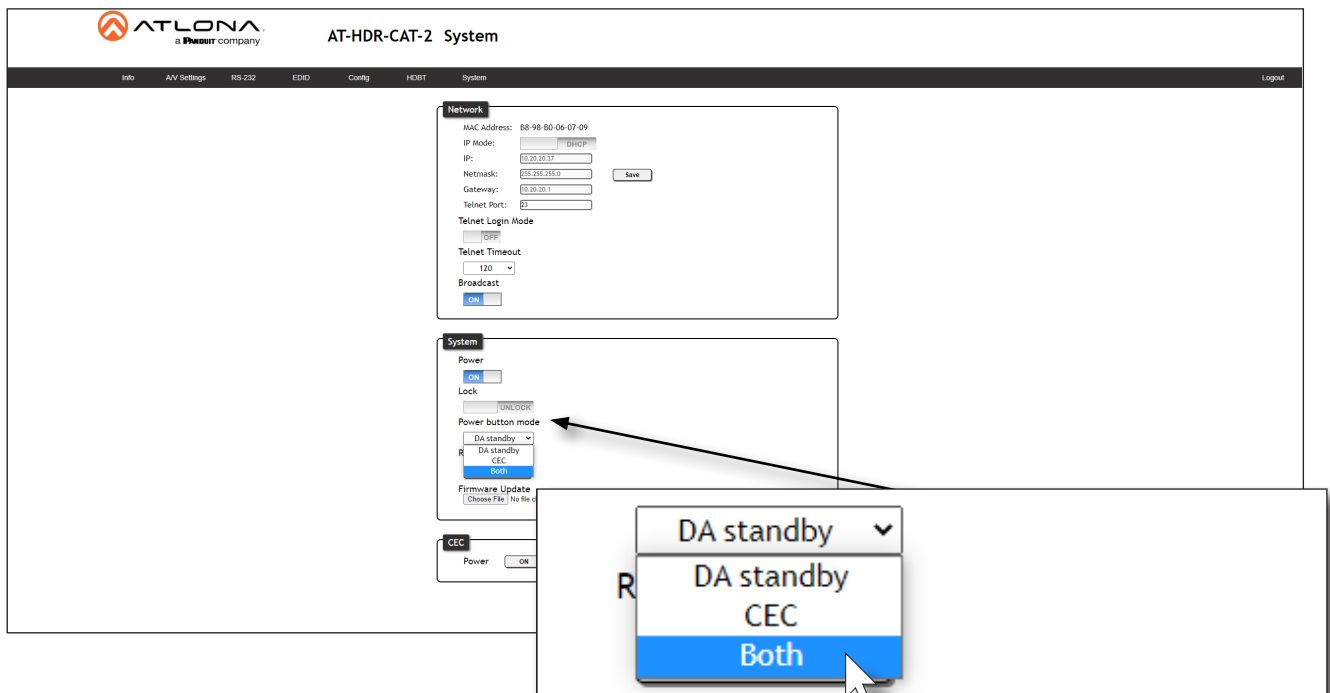

4. Test the CEC power-on and power-off commands for the display (sink) device by clicking the **ON** and **OFF** buttons, near the bottom of the page.

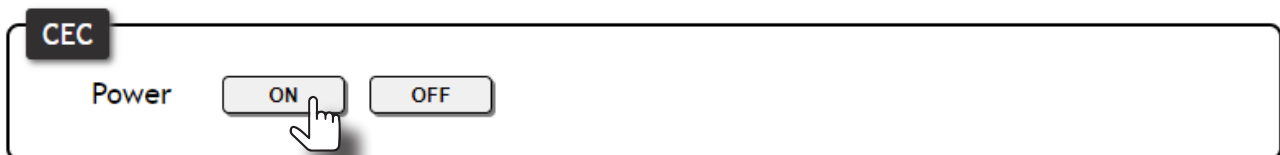

5. Press the **POWER** button on the front panel to power-on or power-off both the display and AT-HDR-CAT-2.

**Consumer Electronics Control (CEC): Atlona has confirmed proper CEC functionality with several current models of Samsung, Panasonic, and Sony displays. However, it is not guaranteed that CEC will work with all displays. Many manufacturers do not support the CEC "off" command, and older displays use proprietary commands. Atlona only supports displays that use the CEC command structure defined in HDMI 1.2a. It is recommended that dealers request an evaluation product from Atlona, before designing a system using the CEC protocol. If this is not possible, then other control methods will need to be considered, in order to control displays using Atlona products.*

Setting the Host Name

By default, the AT-HDR-CAT-2 is assigned a hostname, which is constructed as follows:

CAT-2-[last six digits of MAC address]

For example, a default hostname might look like this: CAT-2-060709. This value can be changed to easily identify the AT-HDR-CAT-2 within the Velocity™ with Integrated AMS or a network. If using a custom hostname, it must meet the hostname standards, defined here: <https://tools.ietf.org/html/rfc1123>

1. Launch a web browser and log in to the web server. Refer to [Logging in to the Web Server \(page 15\)](#).
2. Click **System** in the menu bar.
3. Click the **Hostname** field and enter the desired name.
4. Click **Save** to commit changes.

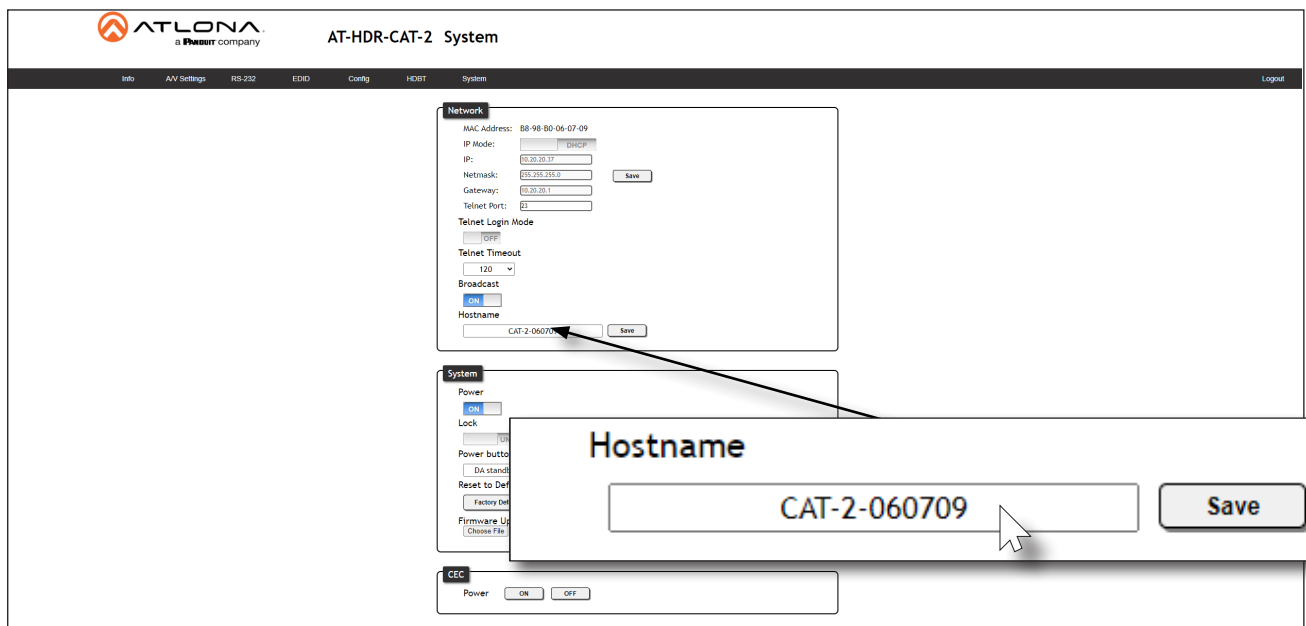

Resetting to Factory-Default Settings

The following procedure will reset the AT-HDR-CAT-2 to factory-default settings. The network IP mode will be set to DHCP mode.

Using the Web Server

1. Launch a web browser and log in to the web server. Refer to [Logging in to the Web Server \(page 15\)](#).
2. Click **System** in the menu bar.
3. Click the **Factory Default** button.

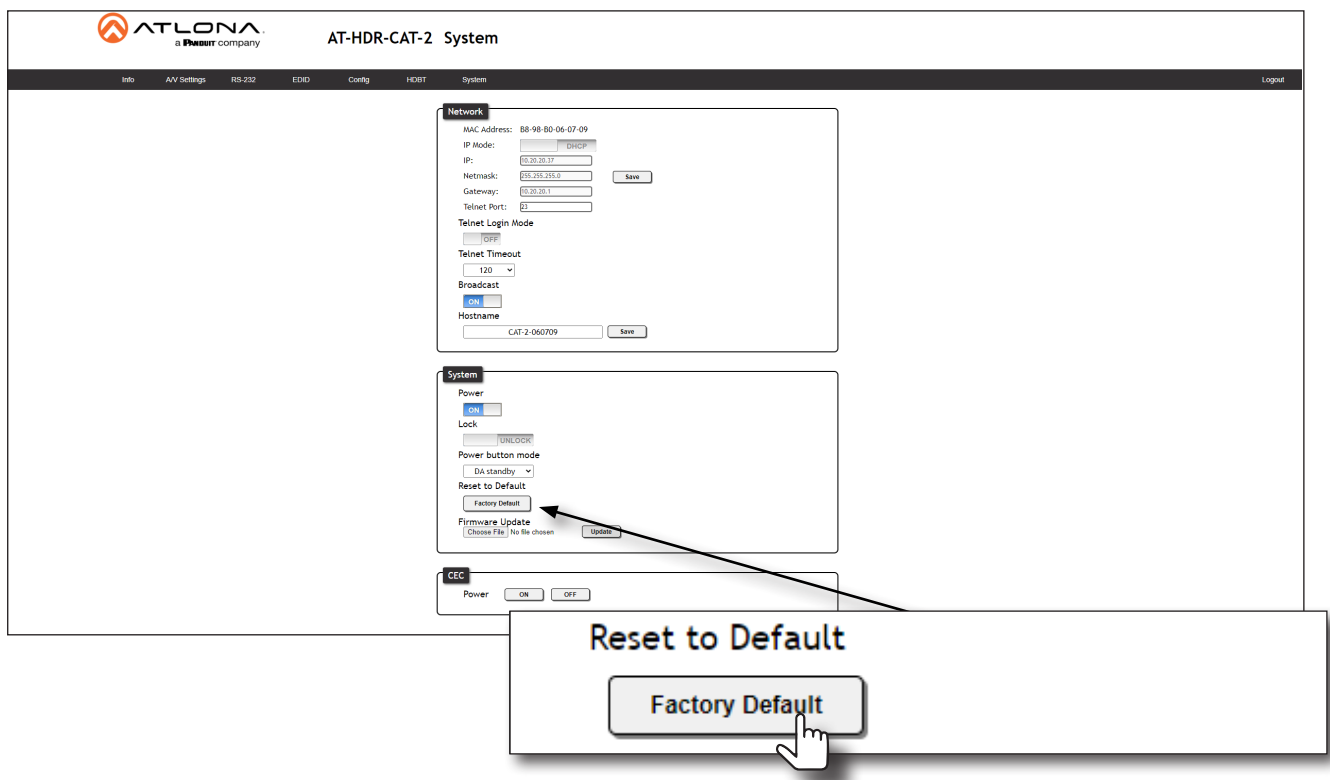

4. The following message will be displayed at the top of the screen. Click **OK** to continue with the factory-default reset procedure. Click **Cancel** to abort the process.



5. Once the factory-default process is complete, the web server **Login** screen will be displayed.
6. The reset process is complete.

Using the Front Panel

1. Press and hold both the **POWER** and **EDID** buttons for 15 seconds.
2. Release both **POWER** and **EDID** buttons once the front panel LED indicators turn on. After two seconds, the front panel LED indicators will turn off.

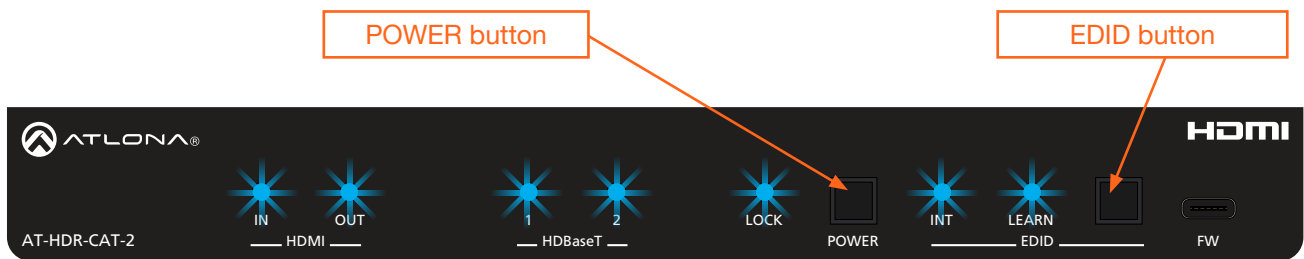

Configuration and Management Interfaces

Web Server

The AT-HDR-CAT-2 includes a built-in web server. Atlona recommends that the web server be used to set up the AT-HDR-CAT-2, as it provides intuitive management of all features. Refer to [Logging in to the Web Server \(page 15\)](#) for more information.

The AT-HDR-CAT-2 is shipped with DHCP enabled. Once connected to a network, the DHCP server will automatically assign an IP address to the unit. Use an IP scanner to determine the IP address of the AT-HDR-CAT-2. If a DHCP server cannot be located within 15 seconds, the AT-HDR-CAT-2 will be placed in [Auto IP \(APIPA\) Mode \(page 13\)](#). If a static IP address is desired, refer to [IP Configuration \(page 11\)](#).

Register page

This page is displayed when the AT-HDR-CAT-2 web server is launched for the first time.

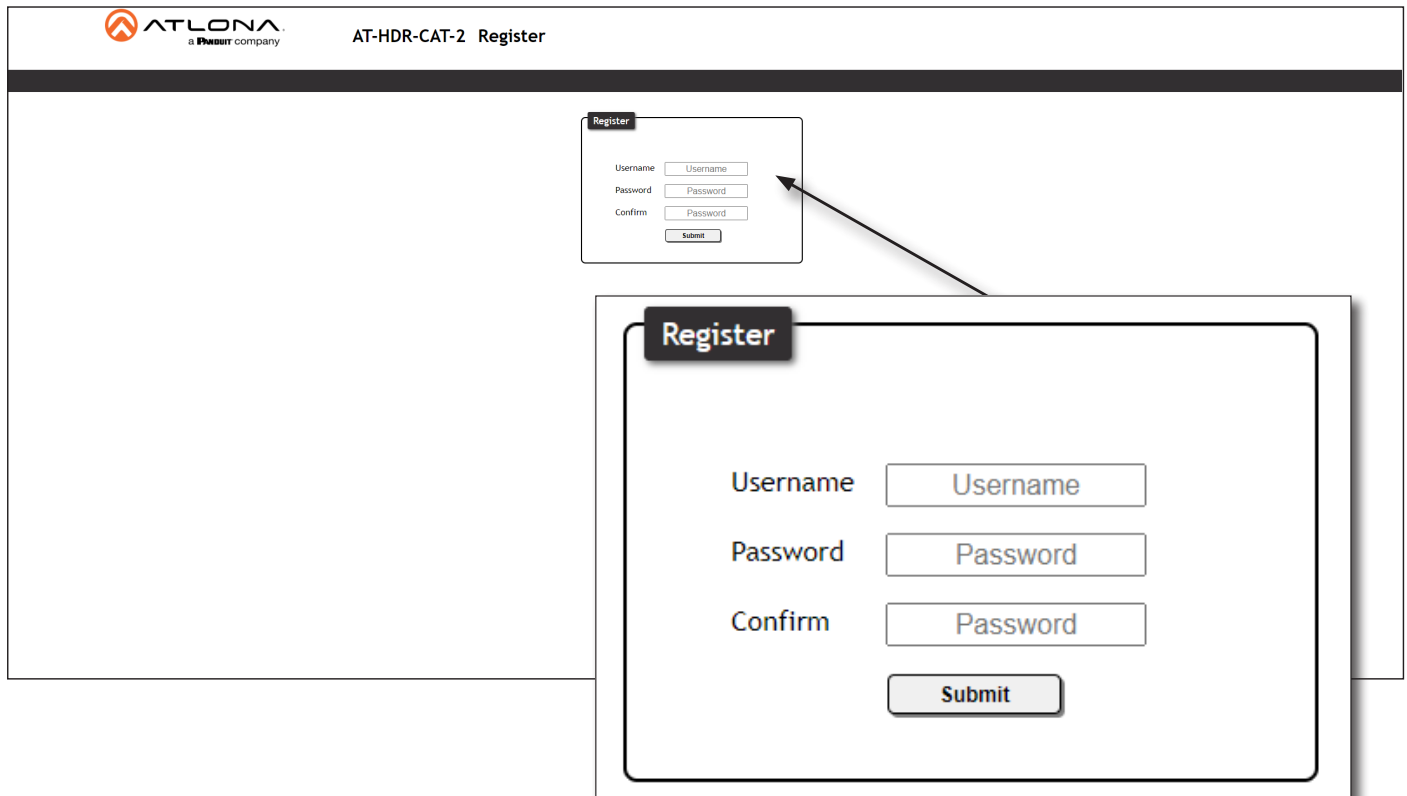

Username

Enter the desired username in this field.

Password

Enter the desired password in this field.

Confirm

Re-enter the desired password in this field.

Submit

Click this button to register the username and password with the AT-HDR-CAT-2.

Configuration and Management Interfaces

Login page

This page is displayed when the IP address of the AT-HDR-CAT-2 is entered in the address bar of a web browser.

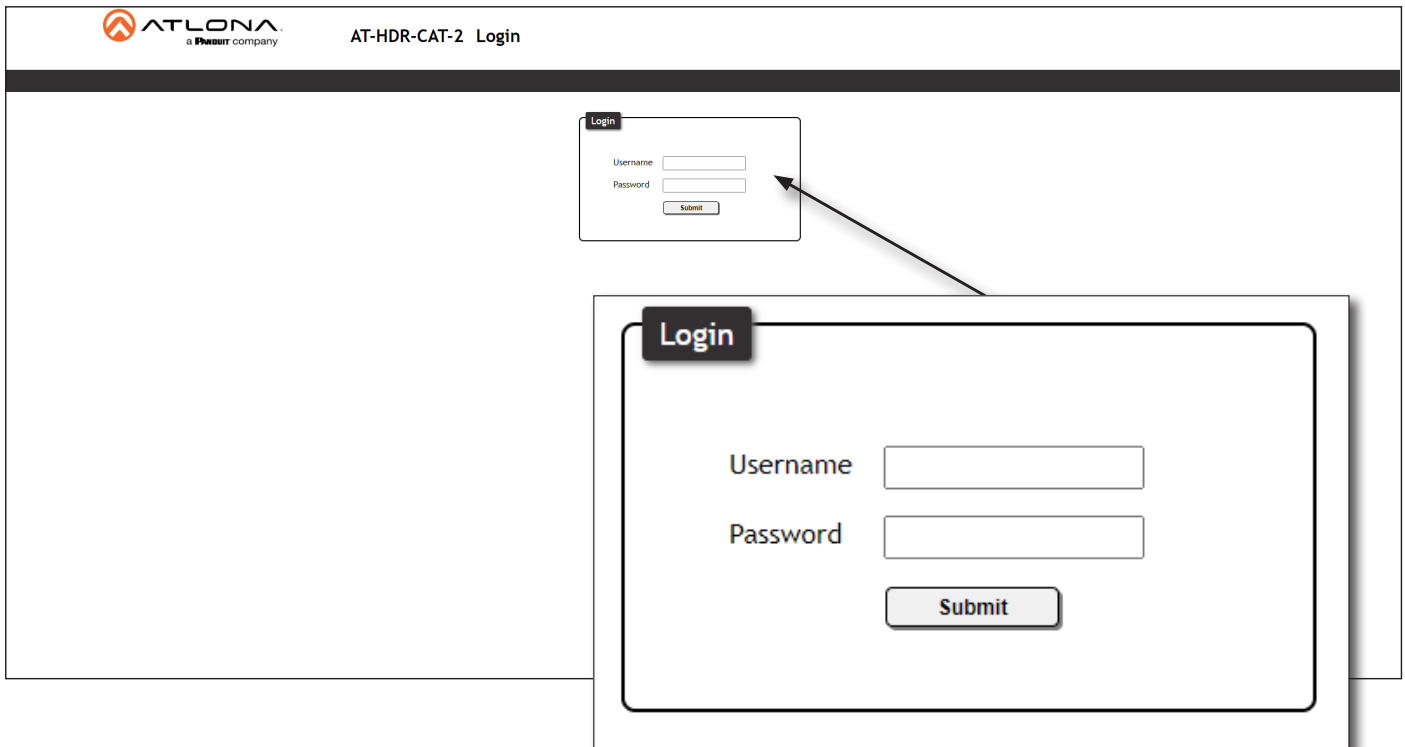

Username

Enter the username in this field.

Password

Enter the password in this field.

Submit

Click this button to log in.

Configuration and Management Interfaces

Info page

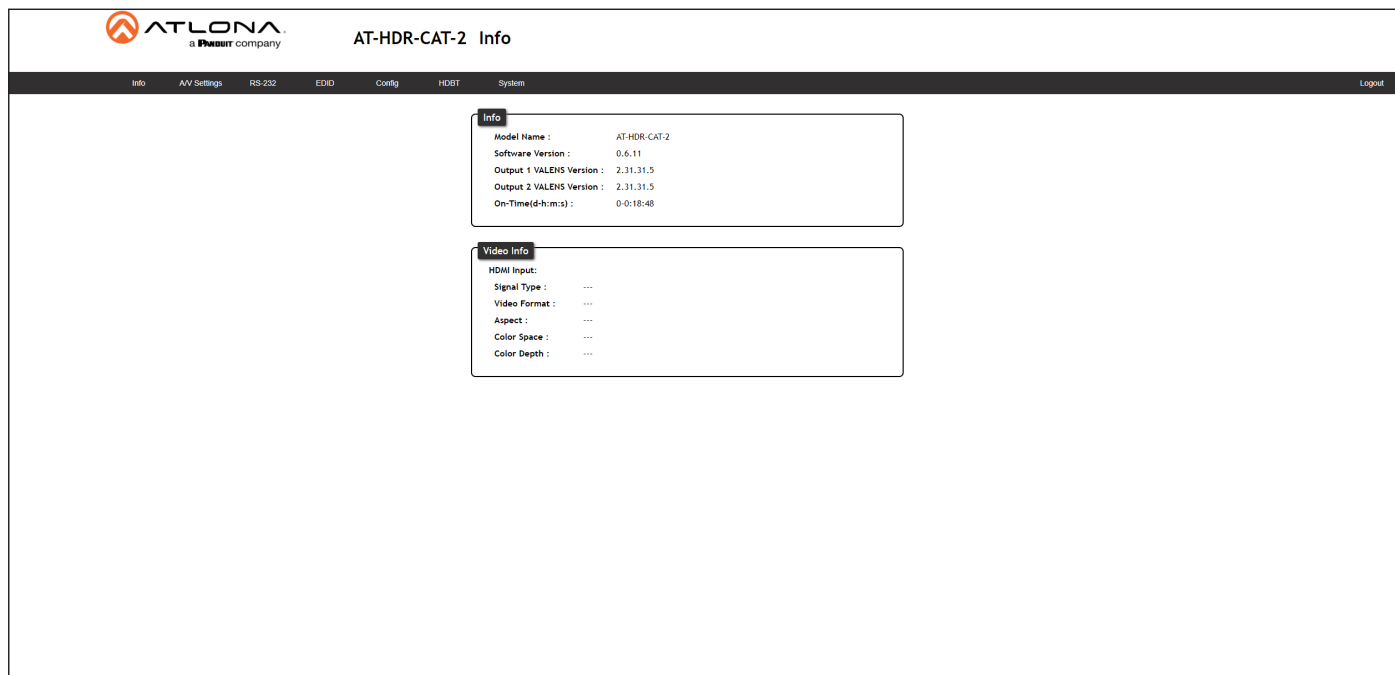

Info

Model Name

The model SKU of this product.

Software Version

The version of firmware that the AT-HDR-CAT-2 is running. Always make sure to check the AT-HDR-CAT-2 product page, on the Atlona web site, for the latest version of firmware.

Output 1 VALENS Version

The version of firmware on the HDBaseT chip for **HDBaseT OUT 1**.

Output 2 VALENS Version

The version of firmware on the HDBaseT chip for **HDBaseT OUT 2**.

On-Time (d-h:m:s)

Displays the amount of time elapsed since the unit was powered.

Video Info

Displays signal information on the HDMI input.

Signal Type

The type of input signal.

Video Format

The input resolution of the source device.

Aspect

Aspect ratio of the input signal.

Color Space

Displays the color space and chroma sub-sampling of the input signal.

Color Depth

The color depth of the input signal.

Configuration and Management Interfaces

A/V Settings page

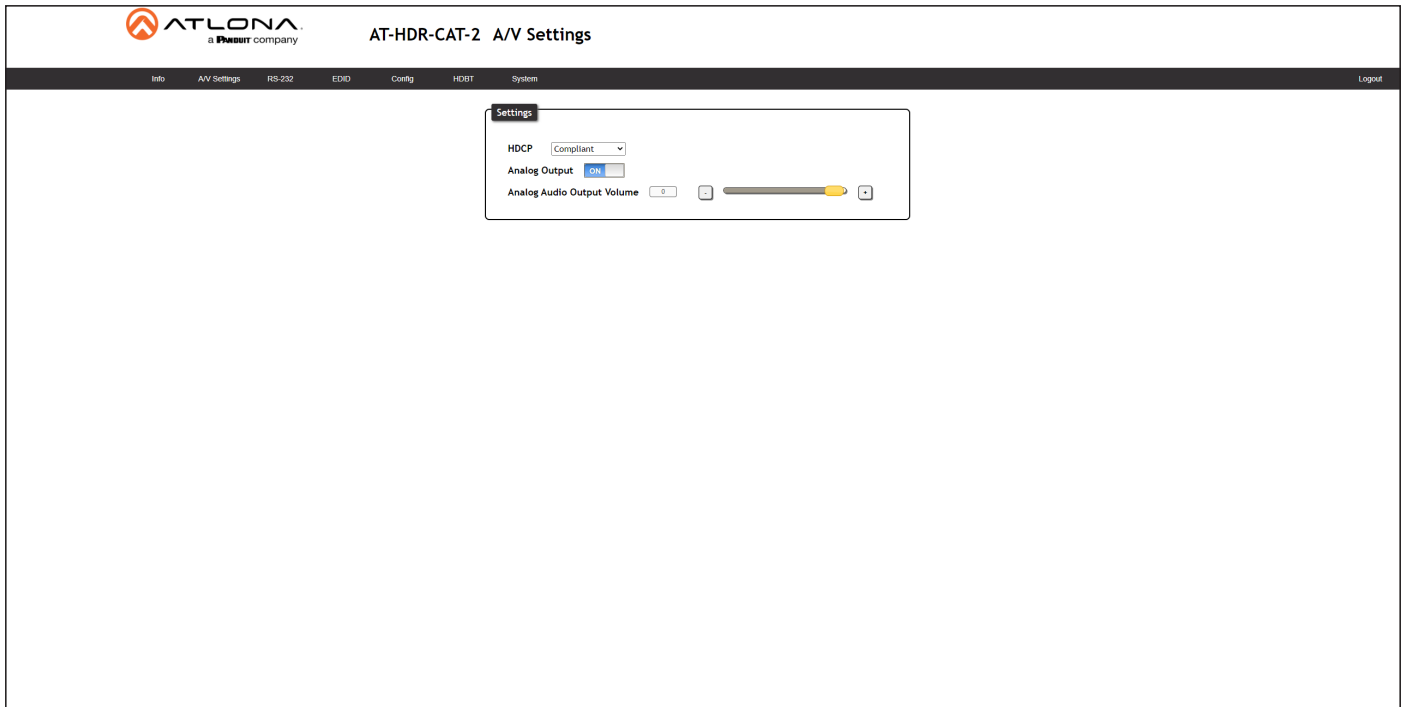

Settings

HDCP

Click this drop-down list to select the HDCP reporting mode.

Setting	Description
Compliant	Allows the source device to send HDCP content to an HDCP-compliant display. This is the default setting.
Non-compliant	Will attempt to force the source device to ignore detection of HDCP-compliant displays, allowing non-HDCP content to be transmitted from the source (if possible). Note that some source devices, such as PlayStation™ console systems and Mac® computers always send HDCP content. Selecting the Non-compliant option <i>will not</i> decrypt or circumvent HDCP-protected content.

Analog Output

Click this toggle switch enable or disable audio output on the **AUDIO OUT** port.

Setting	Description
ON	Audio is de-embedded and sent to the AUDIO OUT port.
OFF	Audio is disabled on the AUDIO OUT port.

Analog Audio Output Volume

Click and drag this slider to adjust the audio volume on the **AUDIO OUT** port.

Configuration and Management Interfaces

RS-232 page

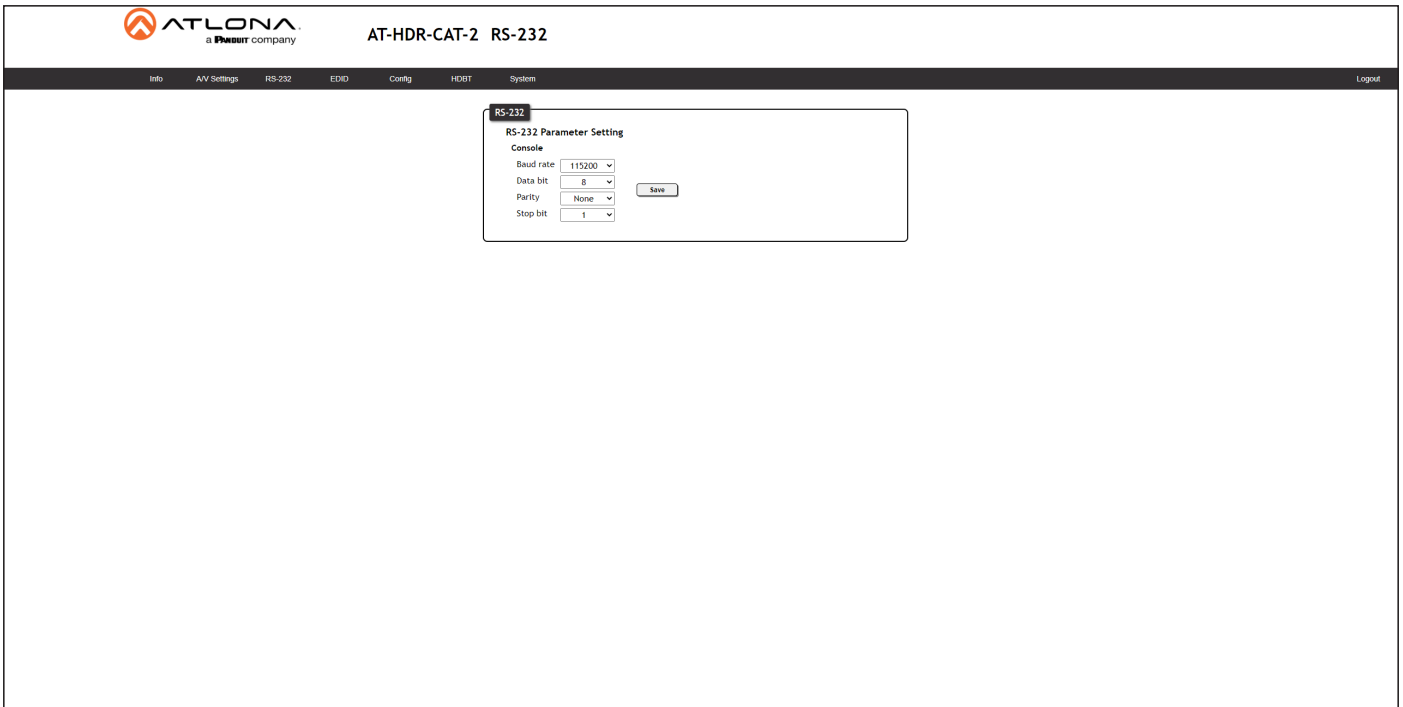

RS-232

RS-232 Parameter Setting

Click each of these drop-down boxes to select the desired baud rate, data bits, parity bit, and stop bit for the **MASTER RS-232 / IR** port.

Setting	Description
Baud rate	Sets the baud rate. The following options are available: 2400, 9600, 19200, 38400, 56000, 57600, 115200.
Data bit	Sets the number of data bits used to represent each character of data. The following options are available: 7 or 8.
Parity	Sets the parity bit, which can be included with each character to detect errors during the transmission of data. The following options are available: None, Odd, or Even.
Stop bit	Sets the stop bit. Stop bits are sent at the end of each character, allowing the client to detect the end of a character stream. The following options are available: 1 or 2.

Configuration and Management Interfaces

EDID page

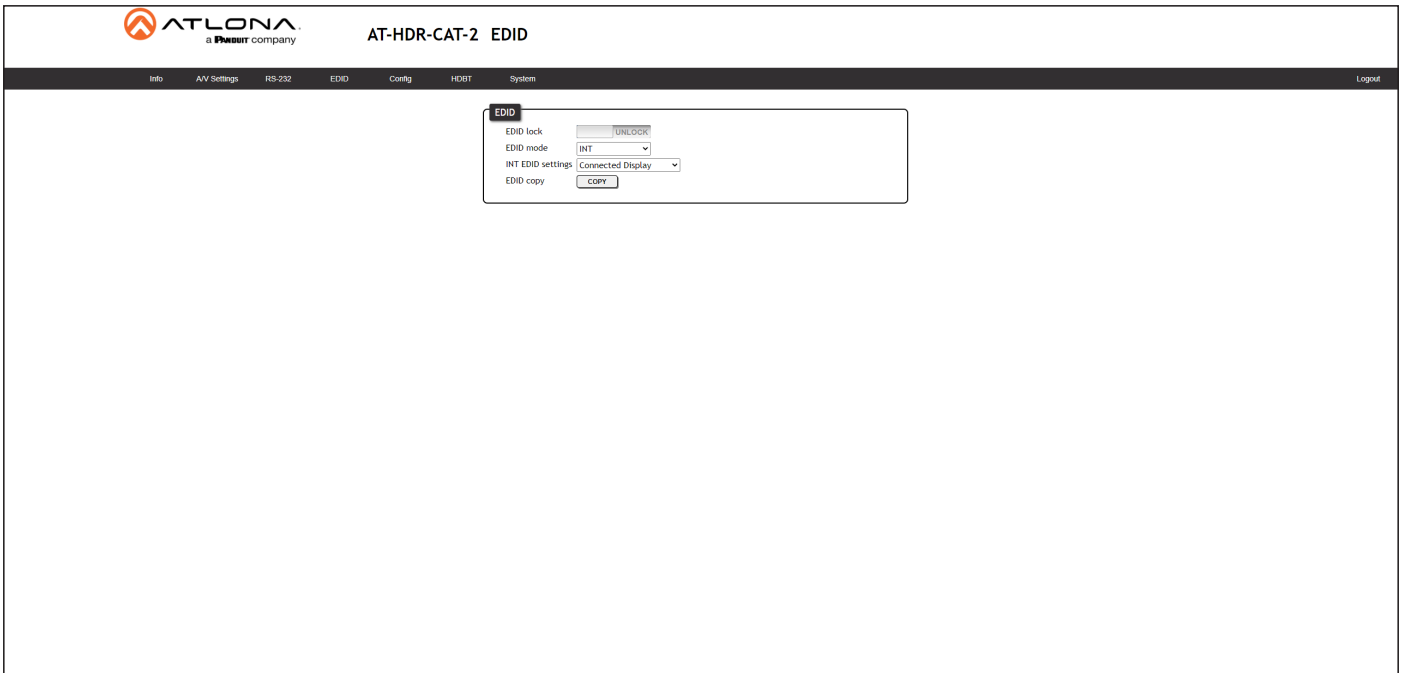

EDID

EDID lock

Click this toggle to switch the EDID lock mode. When set to the **LOCK** position, the **LOCK** LED indicator on the front panel will glow solid blue. Note that in this mode, all front-panel buttons are locked.

EDID mode

Click this drop-down list to select the desired EDID mode.

Setting	Description
INT	Internal mode. Uses the selected internal EDID.
LEARN	Learn mode. Allows the AT-HDR-CAT-2 to read the downstream EDID. Once the EDID is learned, it will be used by the connected source device to determine what video and audio formats can be sent to the sink device. Refer to EDID Management (page 18) for more information.

INT EDID settings

Click this drop-down list to select the desired EDID.

EDID	Description
Connected Display	Uses the downstream EDID of the connected display
ATL 4K60 MCH	3840 x 2160 (UHD) with multichannel audio support
ATL 4K60 PCM MCH	3840 x 2160 (UHD) with PCM multichannel audio support
ATL 1080P MCH	1920 x 1080p with multichannel audio support
ATL 1080P 2CH	1920 x 1080p with two-channel audio support
ATL 1080P DD	1920 x 1080p with Dolby™ Digital audio support
ATL 1080P DVI	1920 x 1080p for DVI displays
ATL 720P DD	1280 x 720p with Dolby™ Digital audio support
ATL 720P 2CH	1280 x 720p with two-channel audio support

EDID copy

Click this button to copy the selected EDID to the **HDMI IN** port.

Configuration and Management Interfaces

Config page

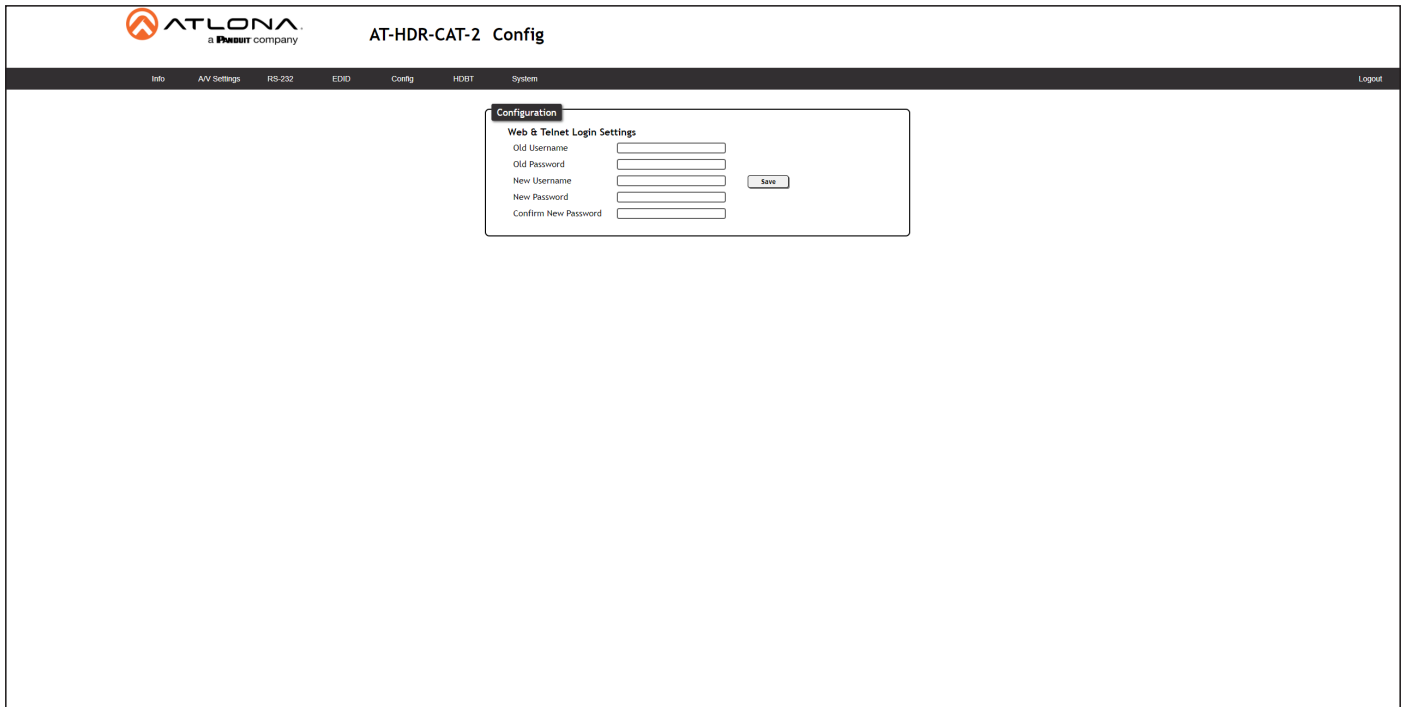

The screenshot shows the AT-LONA configuration interface for the AT-HDR-CAT-2 device. The page title is 'AT-HDR-CAT-2 Config'. The navigation menu includes 'Info', 'AVV Settings', 'RS-232', 'EDID', 'Config', 'HDMI', and 'System'. The 'Config' menu item is active. A 'Configuration' dialog box is displayed, titled 'Web & Telnet Login Settings'. It contains five input fields: 'Old Username', 'Old Password', 'New Username', 'New Password', and 'Confirm New Password'. A 'Save' button is located to the right of the 'New Username' field.

Configuration

Old Username

Enter the current username in this field.

Old Password

Enter the current password in this field.

New Username

Enter the new username in this field.

New Password

Enter the new password in this field.

Confirm New Password

Verify the new password by retying it in this field.

Save

Click this button to apply all changes.

Configuration and Management Interfaces

HDBT page

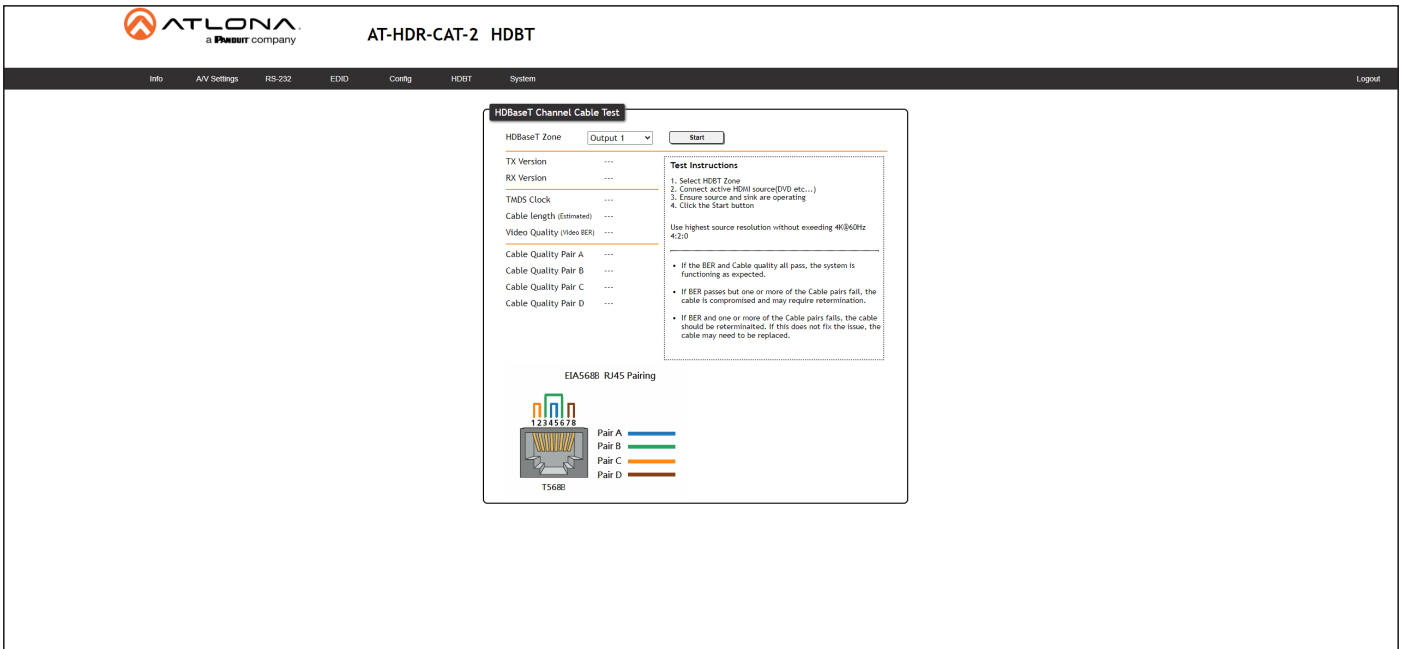

HDBaseT Channel Cable Test

HDBaseT Zone

Click this drop-down list to select the desired HDBaseT output to be tested.

Setting	Description
Output 1	HDBaseT OUT 1
Output 2	HDBaseT OUT 2

Start

Click the **Start** button to begin the HDBaseT testing process. During testing, the button text will change to “Stop”. Click the **Stop** button to halt the HDBaseT testing process. HDBaseT testing can be performed at any time, while the unit is powered. Refer to the instructions on this web page for information on how to interpret the Bit Error Rate (BER) and cable test results.

TX Version

The version of the Valens chip on the transmitter.

RX Version

The version of the Valens chip on the receiver.

TMDS Clock

Displays the pixel clock speed. If no source is connected, then this field will display as “None”.

Cable length (Estimated)

This field indicates the approximate length of the category cable connected between the HDBaseT port on the AT-HDR-CAT-2 and the receiver. If the cable length is less than 15 feet, then this value will be displayed as 0 (zero).

Video Quality (Video BER)

The Bit Error Rate (BER). This field displays either PASS or FAIL during a test.

Cable Quality Pair (A, B, C, D)

Each of these fields will display either PASS or FAIL during a test.

Configuration and Management Interfaces

System page

Network

MAC address

Displays the MAC address of the AT-HDR-CAT-2.

IP Mode

Click this toggle to set the IP mode of the AT-HDR-CAT-2.

Setting	Description
DHCP	Uses an available DHCP server to assign an IP address.
STATIC IP	Allows the IP address, subnet mask, and gateway IP address to be entered manually.

IP

Enter the IP address of the AT-HDR-CAT-2 in this field. This field will only be available if **IP Mode** is set to **STATIC IP**. The default static IP address is 192.168.1.254.

Netmask

Enter the subnet mask in this field. This field will only be available if **IP Mode** is set to **STATIC IP**.

Gateway

Enter the gateway (router) address in this field. This field will only be available if **IP Mode** is set to **STATIC IP**.

Telnet Port

Enter the Telnet listening port in this field.

Telnet Login Mode

Click this toggle to set the login mode to either **ON** or **OFF**. If this feature is set to **ON**, then use the same login credentials as the web server.

Setting	Description
ON	The AT-HDR-CAT-2 will prompt for both the username and password at the start of a Telnet session.
OFF	No username and password is required for Telnet sessions.

Configuration and Management Interfaces

Telnet Timeout

Click this drop-down list to select the timeout interval, in seconds, before the Telnet connection is automatically closed after no activity. Range: 1 to 3600 (seconds).

Broadcast

This option determines whether or not systems changes are announced over TCP/IP connections to any listening devices.

Setting	Description
ON	System changes will be announced over TCP/IP connections to any device that has a TCP/IP connection to the AT-HDR-CAT-2. This is the default setting.
OFF	only the device that is sending the commands will receive feedback from the commands or any system changes. Read queries, such as the <code>IPCFG</code> and <code>Type</code> commands, are not announced and will only return information to the requester.

Hostname

Displays the hostname of the AT-OME-MS42, as it would appear on a network. To change the hostname, type the new hostname in this field and click the **Save** button. Refer to [Setting the Host Name \(page 34\)](#) for more information.

System

Power

Determines the power state of the AT-HDR-CAT-2.

Setting	Description
ON	Under normal operation conditions, this toggle is set to ON.
OFF	Places the AT-HDR-CAT-2 in standby mode. The <code>PWOFF</code> and <code>PWON</code> commands can also be used to control the power state.

Lock

Click to lock or unlock the buttons on the front panel. Locking the front panel buttons is useful in preventing accidental button activation within rack environments.

Setting	Description
LOCK	Locks the front panel buttons.
UNLOCK	Unlocks the front panel button, allowing them to be functional.

Configuration and Management Interfaces

Power button mode

Click this drop-down list to select the desired function of the power button. Refer to [Power Button Modes \(page 30\)](#) for more information.

Setting	Description
DA standby	Pressing the POWER button will toggle the AT-HDR-CAT-2 between standby mode and normal operating mode.
CEC*	When a sink device (display) is connected to the AT-HDR-CAT-2, pressing the POWER button will toggle the power state of the display using the CEC protocol. <i>The power state of the AT-HDR-CAT-2 is unaffected.</i> Power-on and power-off commands are sent over both the HDBaseT OUT and HDMI OUT ports
Both	Pressing the POWER button will toggle the power state of <i>both</i> the AT-HDR-CAT-2 and any sink devices that are connected to the AT-HDR-CAT-2, using the CEC protocol. Power-on and power-off commands are sent over both the HDBaseT OUT and HDMI OUT ports.

Reset to Default

Click the **Factory Default** button to set the AT-HDR-CAT-2 to factory-default settings.

Firmware Update

Click the **Choose File** button to select the firmware file, when upgrading the firmware on the AT-HDR-CAT-2. Once the firmware file is selected, click the **Update** button. Refer to [Updating the Firmware \(page 48\)](#) for more information.

CEC

ON / OFF

Click these buttons to test CEC control between the AT-HDR-CAT-2 and the connected sink device. Click the **ON** button to power-on the device and **OFF** to power-off the device. Refer to [Power Button Modes \(page 30\)](#) for more information.

Button	Description
ON	Sends the CEC command to power-on the device.
OFF	Sends the CEC command to power-off the device.

**Consumer Electronics Control (CEC): Atlona has confirmed proper CEC functionality with several current models of Samsung, Panasonic, and Sony displays. However, it is not guaranteed that CEC will work with all displays. Many manufacturers do not support the CEC "off" command, and older displays use proprietary commands. Atlona only supports displays that use the CEC command structure defined in HDMI 1.2a. It is recommended that dealers request an evaluation product from Atlona, before designing a system using the CEC protocol. If this is not possible, then other control methods will need to be considered, in order to control displays using Atlona products.*

Appendix

Updating the Firmware

Updating the firmware can be completed using either the USB interface or the web server. Atlona recommends using the web server for updating the MCU firmware. However, if a network connection is not available, the AT-HDR-CAT-2 firmware can be updated using a USB-A to USB-C cable.

Using the Web Server

Requirements:

- AT-HDR-CAT-2
 - Firmware file
 - Computer
1. Connect an Ethernet cable from the computer, containing the firmware, to the same network where the AT-HDR-CAT-2 is connected.
 2. Log in to the web server and go to the [System](#) page (page 45).

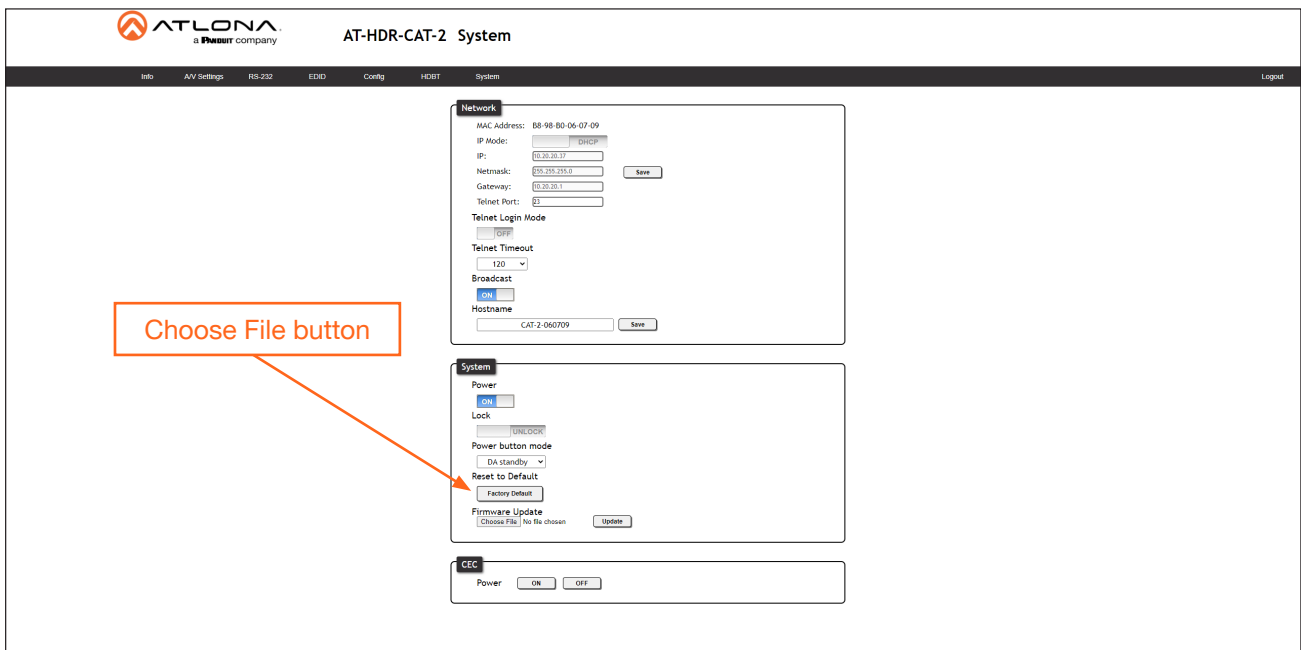

3. Click the **Choose File** button, under **Firmware Update**.
4. Browse to the location of the firmware file, select it, and click the **Open** button.
5. Click the **Update** button to begin the update process. The following message box will be displayed.

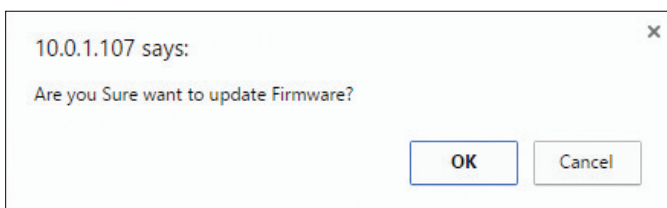

6. Click the **OK** button to begin the firmware update process. Click the **Cancel** button to cancel the process.
7. After the firmware update process is complete, the **Login** screen will be displayed, indicating that the update process is complete.

Using USB

Required items:

- AT-HDR-CAT-2
 - Computer containing the firmware file.
 - USB-A to USB-C cable
1. Disconnect power from the AT-HDR-CAT-2.
 2. Press and hold the **POWER** button while connecting power to the AT-HDR-CAT-2.
 3. Release the **POWER** button. The **POWER** button will glow solid red, indicating that the AT-HDR-CAT-2 is in update mode.
 4. Connect the USB-A to USB-C cable between the PC and the firmware port on the AT-HDR-CAT-2.
 5. A virtual USB drive will be displayed in a pop-up window.
 7. Delete all files from the virtual drive, if any are present.
 8. Drag-and-drop the firmware file to the drive. During the firmware update procedure, the **POWER** button will flash.
 9. After the file has been copied, disconnect the USB cable from both the computer and the AT-HDR-CAT-2.
 10. The firmware update process is complete.

Default Settings

The following tables list the factory-default settings for the AT-HDR-CAT-2.

Feature	Setting	Value
A/V Settings	HDCP	Compliant
	Analog Output	ON
	Analog Output Volume	0
RS-232	Baud rate	115200
	Data bit	8
	Parity	None
	Stop bit	1
EDID	EDID lock	UNLOCK
	EDID mode	INT
	INT EDID settings	Connected Display
System	IP Mode	DHCP
	Static IP Address (default)	192.168.1.254
	Netmask	255.255.0.0
	Gateway	192.168.1.1
	Telnet Port	23
	Telnet Login Mode	OFF
	Telnet Timeout	120
	Broadcast	ON
	Power	---
	Lock	UNLOCK
Power button mode	DA standby	

Specifications

Video	
Signal	Input - HDMI Output - HDMI / HDBaseT
Copy Protection	HDCP 2.2
Pixel Clock	600 MHz
UHD/HD/SD	4096x2160 (DCI) @ 24/25/30/50/60 Hz 720x576p @ 50 Hz 3840x2160 (UHD) @ 24/25/30/50/60 Hz 720x576i @ 25/50 Hz 1920x1080p @ 720x480p @ 60 Hz 23.97/24/25/29.97/30/50/60 Hz 640x480p @ 60 Hz 1920x1080i @ 50/60 Hz 1280x720p @ 30/50/60 Hz
VESA	2560x1600 @ 60 Hz (RB) 1366x768 @ 60 Hz 2048x1536 @ 60 Hz 1360x768 @ 60 Hz 2048x1200 @ 60 Hz 1280x1024 @ 60 Hz 2048x1080 @ 60 Hz 1280x800 @ 60 Hz 1920x1200 @ 60 Hz (RB) 1280x768 @ 60 Hz 1920x1080 @ 60 Hz (RB) 1280x720 @ 60 Hz 1680x1050 @ 60 Hz 1024x768 @ 60 Hz 1600x1200 @ 60 Hz 800x600 @ 60 Hz 1600x900 @ 60 Hz 640x480i @ 29.97/30 Hz 1440x900 @ 60 Hz 1400x1050 @ 60 Hz
Color Space	YUV, RGB
Chroma Subsampling	4:4:4, 4:2:2, 4:2:0
Color Depth	8-bit, 10-bit, 12-bit
HDR	Up to 4K HDR10 @ 60 Hz, 4K Hybrid-Log Gamma (HLG) @ 60 Hz, and 4K Dolby® Vision™ @ 60 Hz ⁽¹⁾

Audio			
HDMI / HDBaseT Pass-Through Formats	PCM 2.0 LPCM 5.1 LPCM 7.1	Dolby® Digital Dolby Digital Plus™ Dolby TrueHD Dolby Atmos®	DTS® Digital Surround™ DTS-HD Master Audio™ DTS:X®
Bit Depth	Up to 24 bits		
Analog Audio			
Format	Stereo 2-Channel		
Balanced Output	+4 dBu nominal gain, +19 dB headroom		
Frequency Response	20 Hz to 20 kHz, ± 0.5 dB		
THD+N	< 0.006% at 20 Hz to 20 kHz		
SNR	> 105 dB at 1 kHz, zero clipping @ 0 dBFS, unweighted		
Sample Rate	32 kHz, 44.1 kHz, 48 kHz, 88.2 kHz, 96 kHz, 176.4 kHz, 192 kHz		

Ethernet	
Port	1 x RJ45
Standards and Protocols	HTTP, Telnet
Speeds	10/100 Mbps
Addressing	DHCP, Static – selectable through front panel, IP & RS-232 commands, and built-in web server

RS-232	
Port	1 x 5-pin captive screw; 1 x 10-pin captive screw
Use	Unit and external device control and configuration
Baud Rates	2400, 4800, 9600, 19200, 38400, 57600, 115200
Data Flow	Bidirectional

IR	
Port	1 x 5-pin captive screw; 1 x 10-pin captive screw
Use	Pass-through from control system to sink device Pass-through from viewing location to source
Frequency Range	30 kHz to 60 kHz

CEC	
Ports	1 x HDMI OUT, Type A, 19-pin female; 2 x RJ45 (HDBaseT OUT)
Triggering	Through IP, RS-232, and built-in web server

Resolution / Distance	4K/UHD - Feet / Meters		1080p - Feet / Meters	
HDMI IN/OUT	15	5	30	10
CAT5e/6	115	35	200	60
CAT6a/7	130	40	230	70

Buttons and Indicators	
Buttons: POWER, EDID	2 x momentary, tact-type
Indicators: HDMI IN/OUT, HDBaseT (1 - 2), LOCK, INT, LEARN	7 x LED, blue

Connectors	
HDMI IN	1 x Type A, 19-pin female
HDMI OUT	1 x Type A, 19-pin female
HDBaseT OUT	2 x RJ45
LAN	1 x RJ45
AUDIO OUT	1 x 5-pin captive screw
RS-232 / IR	3 x 5-pin captive screw
FW	1 x USB-C
DC 48V	1 x 2-pin captive screw

Environmental	Fahrenheit	Celsius
Operating Temperature	+32 to +122	0 to +50
Storage Temperature	-4 to +140	-20 to +60
Operating Humidity (RH)	20% to 90%, non-condensing	

Power	
Consumption (w/ 2 PoE)	38.3 W
Idle Consumption (no PoE)	8.3 W
BTU/h	28.3
External Power Supply	100 - 240 V AC, 50/60 Hz Output: 48 V / 1.25 A DC

Dimensions (H x W x D)		
	Inches	Millimeters
Unit	1.02 x 8.62 x 5.98	26 x 219 x 152
Power Supply (AT-PS-4812-C)	1.34 x 1.85 x 4.41	34 x 47 x 112

Weight		
	Pounds	Kilograms
Device	1.76	0.8

Certification		
Device	CE, RoHS, FCC	
Power Supply	CE, FCC, UL, CUL, TUV-GS, CB, PSE, CCC	

Compliance		
NDAA-889	Yes	
TAA	Yes	

Warranty		
Device	To view the product warranty, use the following link: https://atlon.com/warranty	

Footnotes

- (1) 4K Dolby® Vision™ @ 60 Hz is supported on systems capable of Low Latency Dolby Vision (LLDV) mode.
 All other 4K modes limited to 30 Hz.

